

**CATALOGO RO•RV**  
**RO•RV CATALOGUE /**  
**RO•RV-KATALOG /**





## L'esperienza al servizio dell'innovazione

IT

Dal 1955 il Gruppo Varvel progetta e realizza sistemi di trasmissione di potenza impiegati in numerosi settori dell'industria. "Know-how to do it": Varvel ha le competenze per soddisfare al meglio le richieste dei clienti. Grazie alla grande esperienza maturata in oltre sessant'anni, Varvel offre alla clientela un'ampia gamma di soluzioni standard e prodotti personalizzati per esigenze specifiche. L'intera gamma di prodotti Varvel è progettata e realizzata in Italia, ma il Gruppo è presente in tutto il mondo con due filiali (una in USA e l'altra in India) e una rete globale con oltre 100 partner commerciali.

## Experience at the service of innovation

EN

The Varvel Group has been designing and producing power transmission systems for numerous areas of industry since 1955. "Know-how to do it": Varvel has the know-how needed to satisfy customers' requests in the best way possible. Thanks to over sixty years of accumulated experience, Varvel can offer customers a vast range of standard solutions and customise products for specific needs. The entire product range is designed and made in Italy and sold worldwide through two subsidiaries (in the USA and India) and a global network of over 100 commercial partners.

## Erfahrung im Dienste der Innovation

DE

Die Varvel-Gruppe entwickelt und produziert seit 1955 Kraftübertragungssysteme für viele Industriezweige. "Know-how to do it": Varvel verfügt über das Know-how, um die Anforderungen der Kunden bestmöglich zu erfüllen. Dank der in über sechzig Jahren Firmenaktivität gesammelten Erfahrung kann Varvel seinen Kunden eine breite Palette von Standardlösungen und maßgeschneiderten Produkten für alle spezifischen Anforderungen bieten. Die gesamte Varvel-Produktpalette wird in Italien entwickelt und hergestellt; darüber hinaus ist die Gruppe aber auch weltweit mit zwei Tochtergesellschaften (die eine in den USA und die andere in Indien) und einem globalen Netzwerk mit über 100 Geschäftspartnern präsent.

UNI EN ISO 9001:2015  
UNI EN ISO 14001:2015  
BS OHSAS 18001:2007



EC DIRECTIVE 2014/34/EC (ATEX)



# RO-RV

## RIDUTTORI AD ASSI ORTOGONALI

tre coppie di ingranaggi  
versioni in linea e a squadra



## BEVEL/HELICAL GEARBOXES

three gear trains  
in-line and right angle versions

## KEGELRADGETRIEBE

Dreistufig  
In-Linie- u. Winkelausführungen



INDICE 	CONTENTS 	INDEX 
Descrizione .....2-4	Product description..... 2-4	Produkte .....2-4
Simboli.....5	Symbols ..... 5	Abkürzungen ..... 5
Modularità.....6-7	Modular system..... 6-7	Modularsystem .....6-7
Giunto.....8	Coupling..... 8	Kupplung ..... 8
Selezione Giunto.....9	Coupling Selection ..... 9	Kupplungsauswahl.....9
IEC - Flange & Giunto..... 10	IEC - Flanges & coupling..... 10	IEC- Flansch u. Kupplung ..... 10
NEMA - Flange & Giunto..... 11	NEMA - Flanges & coupling..... 11	NEMA- Flansch u. Kupplung ..... 11
Designazione..... 12	designation..... 12	Bezeichnungen ..... 12
VARsize - Catalogo elettronico ..... 13	VARsize - Electronic catalogue..... 13	VARsize - Elektronischer Katalog ..... 13
Posizioni di montaggio ..... 14	Mounting positions ..... 14	Einbaulage.....14
Fattori di servizio..... 15-16	Service factors ..... 15-16	Betriebsfaktoren..... 15-16
Carichi esterni..... 17	External loads ..... 17	Außere Kräfte ..... 17
<b>Tabelle di Selezione</b>	<b>Selection tables</b>	<b>Auswahltablelle</b>
Versioni..... 18	Versions ..... 18	Ausführungen ..... 18
Potenza termica..... 19	Thermal power ..... 19	Thermische Nennleistung ..... 19
FRO/FRV - SRO/SRV - RO/RV .....20-25	FRO/FRV - SRO/SRV - RO/RV ..... 20-25	FRO/FRV - SRO/SRV - RO/RV .....20-25
MRO/MRV ..... 26-52	MRO/MRV ..... 26-52	MRO/MRV ..... 26-52
<b>Dimensioni</b>	<b>Dimensions</b>	<b>Abmessungen</b>
Motori IEC..... 53	IEC Motors ..... 53	IEC-Motoren ..... 53
RO13-RV13 ..... 54-58	RO13-RV13..... 54-58	RO13-RV13 ..... 54-58
RO23-RV23 ..... 59-63	RO23-RV23..... 59-63	RO23-RV23 ..... 59-63
RO33-RV33 ..... 64-68	RO33-RV33..... 64-68	RO33-RV33 ..... 64-68
RO43-RV43 ..... 69-73	RO43-RV43..... 69-73	RO43-RV43 ..... 69-73
RO53-RV53 ..... 74-78	RO53-RV53..... 74-78	RO53-RV53 ..... 74-78
RO63-RV63 ..... 79-83	RN 62-63..... 79-83	RN 62-63 ..... 79-83
<b>Informazioni generali</b>	<b>General information</b>	<b>Allgemeine Informationen</b>
AC - Alberi cavi ..... 84	AC - Hollow shafts ..... 84	AC - Hohlwellen ..... 84
ACC - Alberi cavi ..... 85	ACC - Hollow shafts ..... 85	ACC - Hohlwellen ..... 85
ACS - Alberi cavi ..... 86	ACS - Hollow shafts..... 86	ACS - Hohlwellen..... 86
Posizione accessori ..... 87	Accessory position ..... 87	Zubehörbaulage..... 87
Rotazione e Parti componenti ..... 88	Rotation and Component parts..... 88	Drehrichtung u. Bauelemente..... 88
Standard motori ..... 89	Motor standards ..... 89	Motoren Standards ..... 89
Riepilogo ATEX ..... 90-91	ATEX summing-up ..... 90-91	ATEX Zusammenfassung ..... 90-91
Uso e Manutenzione ..... 92	Operation and Maintenance ..... 92	Betriebs u. Wartungsanweisung..... 92



La serie dei riduttori RO-RV è concepita secondo le norme di progettazione ISO con l'ausilio di analisi strutturale per verifica della deformata e dello stress.

La robusta struttura non subisce deformazioni significative sotto effetto della coppia di funzionamento e dei carichi esterni con positivi risultati sulle superfici di tenuta.

I riduttori delle serie RO-RV sono costruiti in alluminio pressofuso per le prime 3 grandezze ed in ghisa per le rimanenti.

La versione pendolare permette la conversione in forma flangiata B5 applicando semplicemente una delle diverse flange di uscita disponibili.

Diverse dimensioni e tipi di alberi di uscita (cavo con chiave, cavo con calettatore e pieno con una o due sporgenze) sono disponibili per la più ampia possibilità di applicazioni.

La serie RO-RV è prevista in 6 grandezze, 30 rapporti di riduzione e momenti torcenti fra 180 e 3400 Nm.

La serie dei riduttori RO-RV è costituita da riduttori ad assi ortogonali, con una coppia conica e due cilindriche, e con albero di uscita cavo in esecuzione standard.

### Direttiva ATEX

I riduttori VARVEL-ATEX fornibili su richiesta, sono progettati e costruiti in accordo alla Direttiva 94/9/CE "ATEX" e sono pertanto idonei alla installazione in atmosfere potenzialmente esplosive:

- Zone di Gruppo II
- Categoria 2 (o 3)
- Pericolo di esplosione in presenza di gas (Zona 1 o 2)
- Pericolo di esplosione in presenza di Polveri combustibili (Zona 21 o 22)

Vedi informazioni dettagliate alle pagine 90 e 91.

La serie VARVEL-ATEX viene identificata mediante la seguente marcatura supplementare:

The gearboxes, series RO-RV are designed according to latest ISO engineering specifications with the help of computer aided structural analysis for displacement and stress field.

The monolithic framework does not deflect under the effect of torque and external loads with effective results on sealing surfaces.

The gearboxes of series RO-RV are manufactured of aluminium pressure die cast for the first 3 sizes and of cast iron for the others. The shaft mount version allows the flange mount B5 conversion by simply fitting one of the many output flanges available.

Various dimensions and types of output shafts (hollow with through keyway, hollow with shrink disk and solid with single or double end) are available for the majority of applications.

The series RO-RV is made in 6 sizes for each type of gearboxes, 30 reduction ratios and output torques between 180 and 3400 Nm.

The gearboxes series RO-RV consist of bevel/helical gearboxes with one bevel and two helical trains, and hollow output shaft as standard.

### Directive ATEX

The gearboxes VARVEL-ATEX, supplied on demand, are designed and manufactured according to Directive 94/9/CE "ATEX" and therefore, they are qualified for installation in potentially explosive atmospheres:

- Zones of Group II
- Category 2 (or 3)
- Explosion hazard with gas presence (Zone 1 or 2)
- Explosion hazard with combustible dust presence (Zone 21 or 22)

See detailed information at pages 90 and 91.

The units VARVEL-ATEX are identified by the following additional marking:

Die Getriebe der Baureihe RO-RV nach den ISO Normen konstruiert und anhand von Analysen auf Deformation und Kräfteeinwirkung nachgerechnet sind mit einem gemeinsamen Gehäuse hergestellt und haben somit die gleichen Befestigungsanschlüsse. Die Gehäusestruktur wird von den Betriebsdrehmomenten und durch außen am Getriebe wirkende Kräfte nahezu nicht beeinflusst, was sich positiv auf die Lebensdauer der Wellendichtungen auswirkt. Die ersten drei Größen der Getriebe der Baureihe RO-RV sind aus Aluminiumdruckguss die restlichen aus Grauguß. Die Aufsteckausführung kann in Flanschausführung B5 nachgerüstet werden mittels eines der vielen zur Auswahl stehenden Ausgangsflansche. Eine breite Auswahl an Wellenabmessungen am Ausgang (Hohlwelle mit Nut, Hohlwelle mit Schrumpfscheibe oder Vollwelle ein- oder beidseitig) ist verfügbar. Die Serie RO-RV ist für 6 Baugrößen lieferbar mit 30 Untersetzungen und Ausgangsdrehmomenten zwischen 180 u. 3400 Nm. Die Serie der RO-RV besteht aus Kegelradgetrieben mit einem konischen und zwei zylindrischen Reduktionsmoment und mit einer Ausgangshohlwelle in Standardausführung.

### ATEX Richtlinien

Die Getriebe Varvel-ATEX, ausschließlich auf Anfrage geliefert, sind entsprechend den ATEX-Richtlinien 94/9/ EG "ATEX" konstruiert und hergestellt und somit zugelassen für die Installation in potentiell zündfähigen Atmosphäre:

- Gefahrenbereiche der Gruppe II
- Kategorie 2 (oder 3)
- Explosionsgefährdeter Bereich mit Gase (Gefahrenbereiche 1 oder 2)
- Explosionsgefährdeter Bereich mit zündfähigen Stäube (Gefahrenbereiche 21 oder 22)

Ausführliche Informationen finden Sie auf den Seiten 90 und 91.

Die VARVEL-ATEX Produkte sind mit folgenden zusätzlichen Stempelung versehen:

 II 2 GD ck IP66 CE T<sub>max</sub>=135 °C



RO



RV

<p><b>Serie RO - RV</b> <b>Riduttori ad assi ortogonali</b></p>	<p><b>Series RO - RV</b> <b>Parallel shaft gearboxes</b></p>	<p><b>Baureihe RO - RV</b> <b>Flachgetriebe mit Hohlwelle</b></p>
<p><b>Carcassa multiuso</b> Montaggio con Piedi e Piedi/Flangia Unica carcassa per versione RO e RV</p> <p><b>Carcasse e Coperchi</b> Alluminio in pressofusione (3 grandezze) Ghisa (3 grandezze)</p> <p><b>Entrata</b> Flange IEC e NEMA con giunto elastico o montaggio con foro tradizionale con chiave</p> <p><b>Ingranaggi</b> Acciaio legato Cementato e temprato Profilo dei denti rettificato/sbarbato</p> <p><b>Paraoli</b> Nitrile Butadiene Rubber - NBR come standard; Viton e Silicone a richiesta</p> <p><b>Cuscinetti</b> A sfera o a rulli secondo le grandezze e caratteristiche tecniche</p> <p><b>Uscita</b> Alberi metrici in pollici a richiesta.</p> <p><b>Lubrificazione</b> Olio Sintetico di lunga durata Gradazione ISO VG 320 Senza tappi Riempimento in fabbrica</p>	<p><b>Multipurpose Housing</b> Foot &amp; Foot/Flange Versions Same housing for RO and RV versions</p> <p><b>Housing &amp; Covers</b> Aluminium die cast (3 sizes); Grey cast iron (3 sizes).</p> <p><b>Input</b> IEC and NEMA motor adapters with universal flexible coupling or traditional bore and keyway fitting</p> <p><b>Gearing</b> Alloy steel Case hardened Profile ground or shaved</p> <p><b>Oil seals</b> NBR - Nitrile Butadiene Rubber as standard; Viton and Silicone on request</p> <p><b>Bearings</b> Ball or roller types according to sizes and technical requirements</p> <p><b>Output</b> Solid shafts metric and imperial.</p> <p><b>Lubrication</b> Synthetic long-life oil Grade ISO VG 320 No oil/vent plugs In-house filling</p>	<p><b>Mehrzweckgehäuse</b> Montage mit Fuß, Fuß/Flansch einheitliches Gehäuse für RO u. RV typen</p> <p><b>Gehäuse u. Deckeln</b> Aluminium-Druckguß (3 Größen) Grauguß (3 Größen)</p> <p><b>Eingang</b> Flansche in IEC- u. NEMA-Ausführung mit elastischer Kupplung oder Hochwelle mit Paßfederbindung</p> <p><b>Verzahnungen</b> legierter Stahl Vergütet u. gehärtet geschliffen / rasiert Zahnprofil</p> <p><b>Wellendichtringe</b> Nitributadiengummi NBR als Standard; Viton u. Silikon auf Anfrage</p> <p><b>Lager</b> Kegel- oder Rollenlager nach die Größen u. technische Spezifikationen</p> <p><b>Ausgang</b> metrische Wellen Zollmaß auf Anfrage.</p> <p><b>Schmierung</b> Langzeitschmiermittelfüllung ISO VG 320 ohne zusätzliche Verschlussschrauben Füllung im Werk</p>

	<b>SPECIFICHE GENERALI</b>	<b>GENERAL SPECIFICATIONS</b>	<b>ALLGEMEINE EIGENSCHAFTEN</b>
Gamma Range Bereich	6 grandezze 30 rapporti in 3 coppie di riduzione 3400 Nm coppia uscita max	6 sizes 30 ratios on 3-stages 3400 Nm max. output torque	6 Baugrößen 30 Dreistufige Übersetzungen 3400 Nm max. Abtriebsmoment
Dimensionamento Sizing Auslegung	Secondo ISO6336 / DIN3990 Vita media 10.000 ore con fattore di servizio SF1	According to ISO6336/DIN3990 10,000 hrs average lifetime with service factor SF1	Laut ISO6336/DIN3990 10.000 Stunden Lebensdauer für Verzahnung und Lagerung bei einem Betriebsfaktor SF1
Carcassa. Coperchi Housing. Covers Gehäuse. Flansche	Pressofusione in alluminio fino taglia 3 e ghisa dalla taglia 4	Pressure die cast aluminium up to size 3 and cast iron from size 4	Aluminium-Druckguss bis Größe 3 und Grauguss ab Größe 4
Entrata con giunto G Coupling G input Kupplungseingang G	Pressofusione in alluminio per G3, G5, G6 e acciaio per GS3, GS5, GS6, GS8	Pressure die cast aluminium for sizes G3, G5, G6 and alloyed steel for GS3, GS5, GS6, GS8	Aluminium-Druckguss Größen G3, G5, G6 und Stahl für GS3, GS5, GS6, GS8
Parti dentate Toothed parts Verzahnung	Acciaio cmt / tmp Evolvente rettificato o sbarbato Coppie coniche rodate	Steel case hardened Tooth profile ground or shaved Run-in bevel gears	Stahl einsatzgehärtet Zahnprofil geschliffen / rasiert Kegelräder eingelaufen
Alberi uscita cavi Hollow output shafts Abtriebshohlwelle	Ghisa sferoidale	Ductile cast iron	Duktilen Gusseisen
Alberi & Linguetta Shafts & Keys Wellen	Acciaio Tolleranze: Alberi h6 Fori E8 Linguetta secondo DIN6885 B1	Steel Tolerances: Shafts h6 Bores E8 Keys according to DIN6885 B1	Stahl Toleranzen: Wellen h6 Bohrungen E8 Passfedern nach DIN6885 B1
Cuscinetti Bearings Lagerung	Sfere o rulli secondo grandezza e specifiche tecniche	Ball- or roller-types according to sizes and technical requirements	Kugel- oder Rollenlager entsprechend den technischen Vorschriften
Paraolio Oil seals Dichtungen	Tipo NBR - Nitril-Butadiene Rubber con secondo labbro parapolvere secondo DIN 3760 Tipo FKM - Fluoro-elastomero Viton a richiesta	Type NBR - Nitril-Butadiene Rubber with additional anti-dust lip according to DIN 3760 Type FKM - Fluoroelastomer Viton on demand	Typ NBR - Nitril-Butadien Rubber mit zusätzlicher Staublippe entsprechend DIN 3760 Typ FKM - Fluoroelastomer Viton auf Anfrage
Lubrificante Lubricant Schmierung	Olio sintetico a lunga durata Gradazione ISO VG 320	Synthetic long-life oil Grade ISO VG 320	Synthetisches Getriebeöl ISO VG 320 als Langzeit-Füllung
Verniciatura Powder coating Gehäuselackierung	Alluminio naturale fino taglia 3 e vernice a polveri epossidiche colore standard RAL 7012 dalla taglia 4	Aluminium until size 3 From size 4 epoxy powder-coating Standard colour RAL 7012	Aluminium bis Größe 3 Epoxydpulverfarbe Standard-farbtone RAL 7012 ab Größe 4
ATEX	A richiesta	On demand	Auf Anfrage

<b>Simbolo Symbol Abkürzung</b>	<b>Descrizione</b>	<b>Description</b>	<b>Beschreibung</b>
D [mm]	Diametro primitivo dell'elemento di trasmissione $k_{(t)}$	PCD of transmission element $k_{(t)}$	Wirkkreisdurchmesser des Übertragungselementes $k_{(t)}$
$F_r$ [N]	Carico radiale dell'applicazione	Application radial load	Radialkraft der Anwendung
$F_{r1}$ [N]	Carico radiale di catalogo (entrata)	Catalogue radial load (input)	Radialkraft aus dem Katalog (Eingang)
$F_{r2}$ [N]	Carico radiale di catalogo (uscita)	Catalogue radial load (output)	Radialkraft aus dem Katalog (Ausgang)
$F_{r2b(x)}$ [N]	Carico radiale ammissibile in posizione "X" sull'albero di uscita. Basato sulla vita dei cuscinetti	Permissible radial load at position "X" on output shaft. Based on bearing lifetime	Zulässige Radialkraft an der Position "X" der Ausgangswelle basierend auf der Lagerlebensdauer
$F_{r2s(x)}$ [N]	Carico radiale ammissibile come $F_{r2b(x)}$ Basato sulla resistenza a flessione e torsione dell'albero.	Permissible radial load same as $F_{r2b(x)}$ Based on shaft bending and torsional stress.	Zulässige Radialkraft wie $F_{r2b(x)}$ aber basierend auf Biegung und Verdrehung der Ausgangswelle.
FS	Fattore di servizio Service factor Betriebsfaktor	$FS = \frac{M_2}{M_{(app)}}$	
$i_n$	Rapporto di riduzione nominale	Nominal reduction ratio	Nominelle Übersetzung
$i_r$	Rapporto di riduzione reale	Actual reduction ratio	Tatsächliche Übersetzung
$J_1$ [kgm <sup>2</sup> ]	Momento d'inerzia del riduttore all'albero di entrata del riduttore	Moment of inertia of the gearbox at gearbox input shaft	Trägheitsmoment des Getriebes an der Eingangswelle
$J_2$ [kgm <sup>2</sup> ]	Momento d'inerzia dell'applicazione	Moment of inertia of the application	Trägheitsmoment der Anwendung
$J_m$ [kgm <sup>2</sup> ]	Momento d'inerzia del motore	Moment of inertia of the motor	Trägheitsmoment des Motors
$k_{(a)}$	Fattore d'accelerazione delle masse	Mass acceleration factor	Beschleunigungsfaktor der Massen
$k_{(t)}$	Fattore dell'elemento della trasmissione	Transmission element factor	Kennwert des Übertragungs-Elements
Lub H/V [l]	Lubrificante (litri) H - Montaggio orizzontale V - Montaggio verticale	Lubricant (litres) H - Horizontal mounting V - Vertical mounting	Schmierstoff (Liter) H - waagrechte Einbaulage V - senkrechte Einbaulage
$M_2$ [Nm]	Coppia massima di uscita del riduttore Gearbox maximum output torque Abtriebsdrehmoment des Getriebes	$M_2 = \frac{9550 * P_1 * \eta}{n_2}$	
$M_{(app)}$ [Nm]	Coppia dell'applicazione	Application torque	Erforderliches Drehmoment der Anwendung
$n_1$ [rpm]	Velocità di entrata	Input speed	Eingangsdrehzahl
$n_2$ [rpm]	Velocità di uscita	Output speed	Ausgangsdrehzahl
$P_1$ [kW]	Potenza in entrata Input power Motorleistung	$P_1 = \frac{M_2 * n_2}{9550 * \eta}$	
$P_{(kg)}$ [kg]	Peso per montaggio B3H e rapporto di riduzione medio	Weight: for mounting B3H and average reduction ratio	Gewicht für Bauform B3H und durchschnittliche Getriebeübersetzungen
$\eta$	Rendimento Efficiency Wirkungsgrad	$\eta = 0.96$ - 2 coppie. stages. Stufen $\eta = 0.94$ - 3 coppie. stages. Stufen	

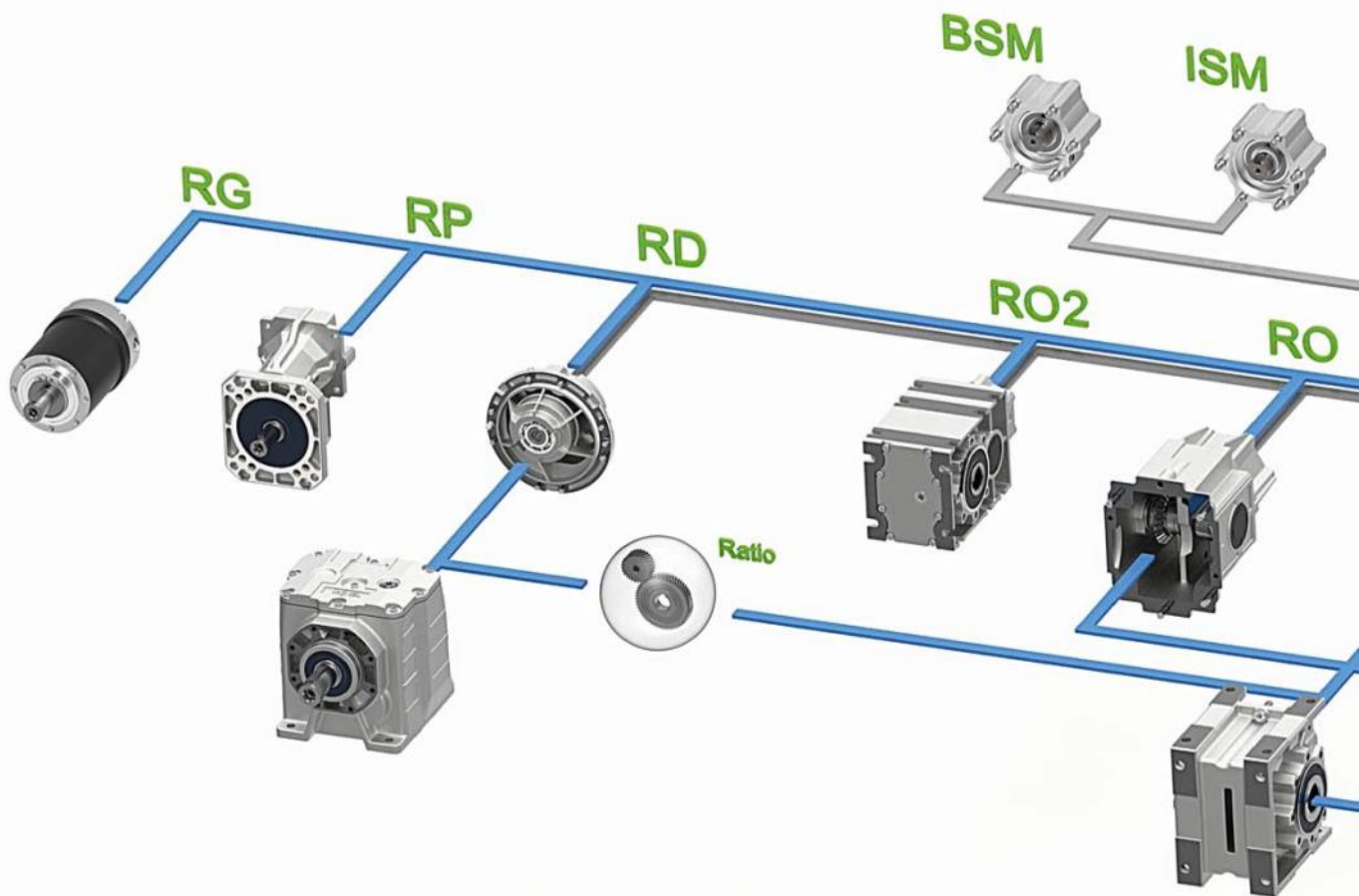



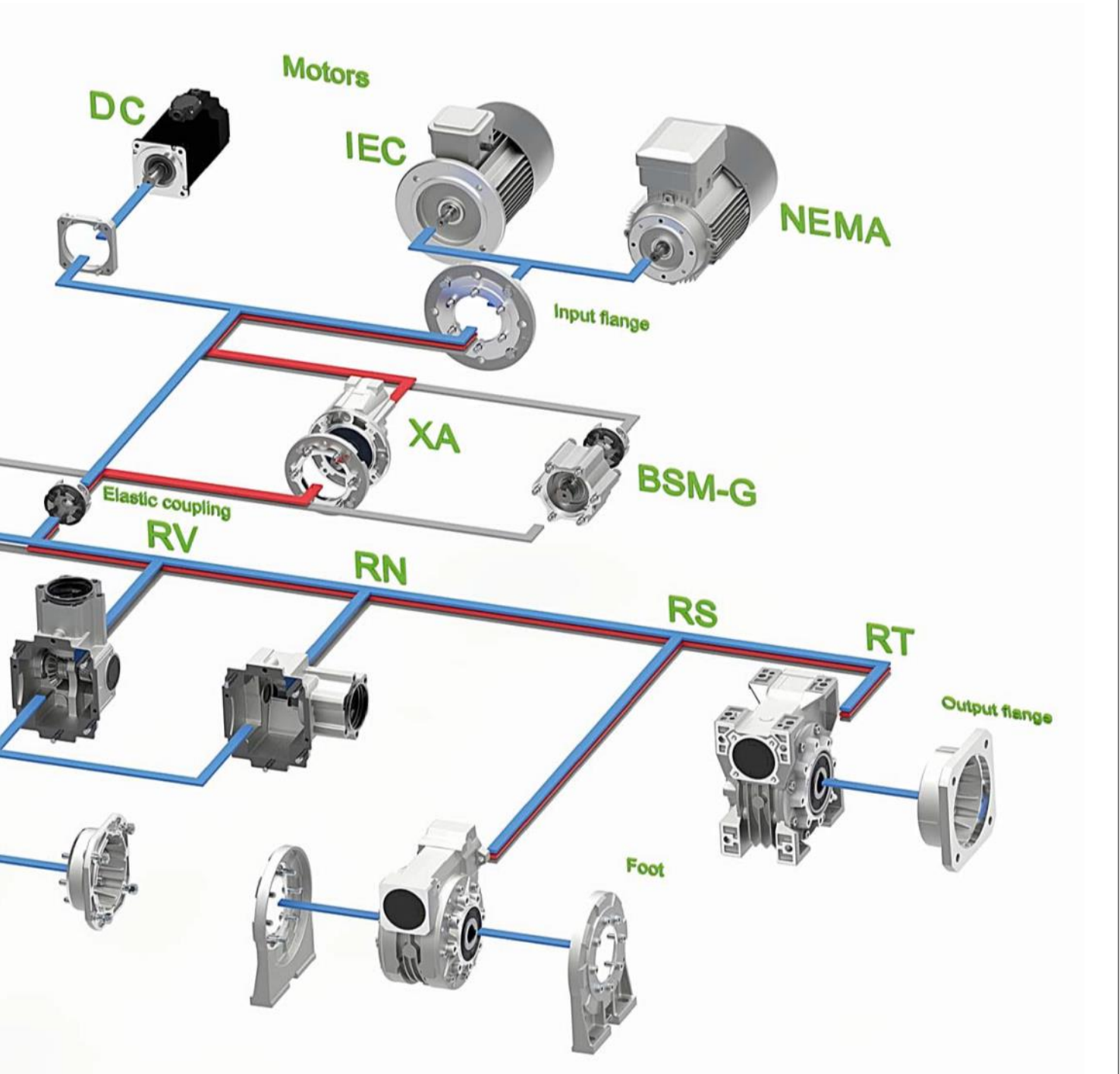

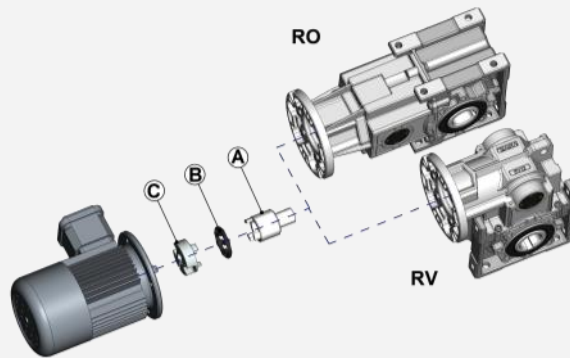

### A) Semi-giunto riduttore

- Materiale: acciaio
- Integrale con albero entrata
- Supportato con due cuscinetti
- Dimensioni lato entrata invariate

### B) Anello elastico

- Denti: collegati esternamente
- Materiale: Elastomero Termoplastico IXEF® - Polyarylamide
- Durezza 90 Shore D
- Temperatura -30/+135° C (-22/+275°F)

### C) Semi-giunto motore

- Materiale:
  - Alluminio pressofuso (G3, G5, G6)
  - Acciaio (GS3, GS5, GS6, GS8)
- Bilanciatura dinamica
- Calettamento:
  - Morsetto (G3, G5, G6)
  - Chiavetta (GS3, GS5, GS6, GS8)
- Fori disponibili secondo:
  - IEC 72 / DIN42948
  - NEMA C e TC

### Vantaggi:

- Un solo riduttore per rapporto di riduzione
- Maggiore flessibilità
- Aumentata rotazione dello stock
- Eliminazione sfregamento fra chiavetta e cava (tribocorrosione)
- Collegamento riduttore / motore con gioco zero
- Disallineamento angolare ammesso max 1°
- Elevata rigidità torsionale
- Elevato smorzamento delle vibrazioni

### Flange entrata:

- Materiale:
  - Alluminio fino IEC112 e NEMA TC180
  - Ghisa da IEC 132 e NEMA TC200

### A) Reducer-side coupling hub

- Material: steel
- One piece machined on input shaft
- Two bearing setting
- Unchanged casing dimensions

### B) Spider

- External tooth connection
- Material: Thermoplastic Elastomer: IXEF® - Polyarylamide
- Hardness 90 Shore D
- Temperature -30/+135°C (-22/+275°F)

### C) Motor-side coupling hub

- Material:
  - Aluminium pressure die cast (G3, G5, G6)
  - Steel (GS3, GS5, GS6, GS8)
- Dynamic balancing
- Fitting:
  - Clamp (G3, G5, G6)
  - Key (GS3, GS5, GS6, GS8)
- Bores, available according to:
  - IEC 72 / DIN42948
  - NEMA C and TC

### Advantages:

- One gearbox only for each reduction ratio
- Greater flexibility
- Increased stock rotation
- Elimination of fretting corrosion between key and keyway
- Gearbox / motor connection with zero backlash
- Allowed angular misalignment 1° max.
- High torsional rigidity
- High vibration damping

### Input flanges:

- Material:
  - Aluminium up to IEC112 & NEMA TC180
  - Cast iron from IEC 132 & NEMA TC200

### A) Getriebekupplungshäfte

- Material: Stahl
- integrata Eingangswelle
- Zwei-Lager-Anordnung
- unveränderte Eingang Abmessungen

### B) Kupplungsscheibe

- Äußerliche Zahnverbindung
- Material Thermoplastisch Elastomer: IXEF® - Polyarylamide
- Härte 90Shore D
- Temperatur -30/+135° C (-22/+275°F)

### C) Motorkupplungshäfte

- Material:
  - Aluminium Druckguss (G3, G5, G6)
  - Stahl (GS3, GS5, GS6, GS8)
- dynamische Auswuchtung
- Verkeilung:
  - Klammer (G3, G5, G6)
  - Keil (GS3, GS5, GS6, GS8)
- Bohrungen, nach:
  - IEC 72 / DIN42948
  - NEMA C u. TC

### Vorzüge:

- nur eine Getriebekomponente je Übersetzung
- gesteigerte Flexibilität
- höher Lagerumschlag
- Vermeidung von Passungsost zwischen Keil u. Keil Einschnitt
- Getriebe / Motor Spielfrei Verkeilung
- erlaubt Winkelausgleich bis 1°
- hohe Verdrehsteifigkeit
- hohe Dämpfung von Schwingungen

### Eingangsflansche:

- Material:
  - Aluminium bis IEC112 u. NEMA C180
  - Grauguss ab IEC 132 u. NEMA C200

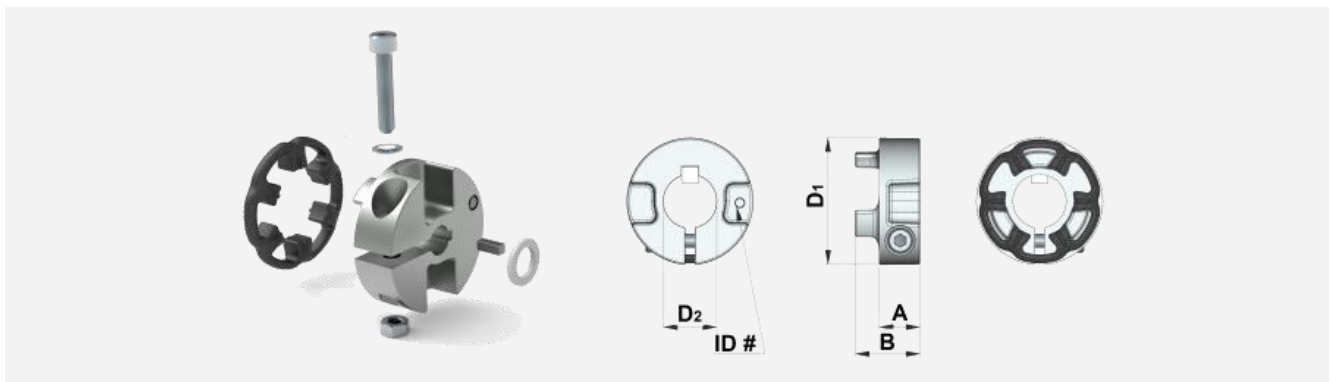

Tipo Type Typ	IEC NEMA	Codice Kit Kit Part No. Kit Teil Nr.	RO - RV	Mt [Nm]	Mt <sub>1</sub> [Nm]	Mt <sub>2</sub> [Nm]	A [mm]	B [mm]	D <sub>1</sub> [mm/ inch]	D <sub>2</sub> [mm/ inch]	ID#
G5	IEC	KG5.009/X KG5.011/X KG5.014/X KG5.019/X KG5.024/X	RO13 - RV13	10	14 15 30 40 70	10 10 17 25 40	14.5	23	45 45 45 45 52	9 11 14 19 24	509 511 514 519 524
	NEMA	KG5.N56/X KG5.N140/X	RO13 - RV13		45 60	35 45			1.77 2.05	5/8" 7/8"	5N56 5N140
G6	IEC	KG6.014/X KG6.019/X KG6.024/X KG6.028/X KGS6.038X	RO23 - RV23 RO33 - RV33 RO43 - RV43	18	60 90 130 180 500	40 65 100 120 ---	19.5	31.5	58	14 19 24 28 38	614 619 624 628 ---
	NEMA	KG6.N56/X KG6.N140/X KG6.N180/X	RO-RV23-33-43 RO-RV23-33-43 RO-RV43		50 85 200	--- --- ---			2.28	5/8" 7/8" 1-1/8"	6N56 6N140 6N180
GS8	IEC	KGS8.19/X KGS8.24/X KGS8.28/X KGS8.38/X KGS8.42/X KGS8.48/X	RO53 - RV53 RO63 - RV63	15	150 250 350 500 500 500	--- --- --- --- --- ---	35	51	79	19 24 28 38 42 48	* * * * * *
	NEMA	KGS8.N056/X KGS8.N140/X KGS8.N180/X KGS8.N210/X KGS8.N250/X	RO-RV53-63 RO-RV53-63 RO-RV53-63 RO-RV53-63 RO-RV63		140 200 300 500 500	--- --- --- --- ---			3.11	5/8" 7/8" 1-1/8" 1-3/8" 1-5/8"	* * * * *

Mt - Coppia di serraggio vite  
 Mt<sub>1</sub> - Coppia trasmissibile con chiavetta  
 Mt<sub>2</sub> - Coppia trasmissibile senza chiavetta  
 \* - Giunto GS8: serraggio con chiavetta e grano di bloccaggio assiale  
 ../X - Codice del giunto con anello nero IXEF

**Nota** - Nessun ID# marcato sul Giunto GS8

Mt - Screw locking torque  
 Mt<sub>1</sub> - Transmissible torque with key  
 Mt<sub>2</sub> - Transmissible torque without key  
 \* - Coupling GS8: steel. key fit and grub screw  
 ../X - Code of coupling with IXEF black-spider

**Note** - No ID# marked on Coupling GS8

Mt - Schraubenklemmengrehmoment  
 Mt<sub>1</sub> - übertragbar Drehmoment mit Keil  
 Mt<sub>2</sub> - übertragbar Drehmoment ohne Keil  
 \* - Kupplung GS8: Stahl. Keilverkeilung u. gewindestift  
 ../X - Kupplungscode mit schwarzen IXEF-Ring

**Anmerkung** - Kein ID# auf dem Kupplung GS8 markiert ist

Riduttore Gearbox Getriebe	Flangia - Flange - Flansch				Giunto - Coupling - Kupplung	
	Tipo - Type - Typ	IEC	Kit Part No. B5	Kit Part No. B14	Tipo - Type - Typ	Kit Part No.
RO13 RV13	FM 50	IEC56 IEC63 IEC71 IEC80 IEC90	K532.206.120 K532.206.140 K532.206.160 K532.206.200 K532.206.200	--- K532.206.090 K532.206.105 K532.206.120 K532.206.140	G5 ø9 G5 ø11 G5 ø14 G5 ø19 G5 ø24	KG5.009/X KG5.011/X KG5.014/X KG5.019/X KG5.024/X
RO23 RV23	FM 70	IEC71 IEC80 IEC90 IEC 100/112	K533.206.160 K533.206.200 K533.206.200 K533.206.250	K533.206.105 K533.206.120 K533.206.140 K533.206.160	G6 ø14 G6 ø19 G6 ø24 G6 ø28	KG6.014/X KG6.019/X KG6.024/X KG6.028/X
RO33 RV33	FM 85	IEC71 IEC80 IEC90 IEC 100/112	K534.206.160 K534.206.200 K534.206.200 K534.206.250	--- K534.206.120 K534.206.140 K534.206.160	G6 ø14 G6 ø19 G6 ø24 G6 ø28	KG6.014/X KG6.019/X KG6.024/X KG6.028/X
RO43 RV43	FM 110	IEC71 IEC80 IEC90 IEC 100/112 IEC132	K535.206.160 K535.206.200 K535.206.200 K535.206.250 K535.206.300	--- --- --- K535.206.160 K535.206.200	G6 ø14 G6 ø19 G6 ø24 G6 ø28 Gs6 ø38	KG6.014/X KG6.019/X KG6.024/X KG6.028/X KGS6.038/X
RO53 RV53	FM 130 & FM 150	IEC 80 IEC 90 IEC 100/112 IEC 132 IEC 160 IEC 180	K536.206.200 K536.206.200 K536.206.250 K537.206.300 K565.206.350 K565.206.350	--- --- --- K536.206.200 --- --- ---	** GS8 ø19 ** GS8 ø24 ** GS8 ø28 ** GS8 ø38 ** GS8 ø42 ** GS8 ø48	KGS8.019/X KGS8.024/X KGS8.028/X KGS8.038/X KGS8.042/X KGS8.048/X
RO63 RV63	FM 130 & FM 150	IEC 80 IEC 90 IEC 100/112 IEC 132 IEC 160 IEC 180	K536.206.200 K536.206.200 K536.206.250 K537.206.300 K565.206.350 K565.206.350	--- --- --- K536.206.200 --- --- ---	** GS8 ø19 ** GS8 ø24 ** GS8 ø28 ** GS8 ø38 ** GS8 ø42 ** GS8 ø48	KGS8.019/X KGS8.024/X KGS8.028/X KGS8.038/X KGS8.042/X KGS8.048/X

\*\* - Giunto GS8: montaggio con chiavetta e grano di bloccaggio assiale  
 ../X - Codice del giunto con anello nero IXEF

\*\* - Coupling GS8: key fitting and axial locking grub screw  
 ../X - Code of coupling with IXEF black-spider

\*\* - Kupplung GS8: Keilmontage u. gewindestift  
 ../X - Kupplungscode mit schwarzen IXEF-Ring

Riduttore Gearbox Getriebe	Flangia - Flange - Flansch			Giunto - Coupling - Kupplung	
	Tipo - Type - Typ	NEMA	Kit Part No.	Tipo - Type - Typ	Kit Part No.
RO13 RV13	FM 50	56 C 140 TC	K532.227.N56 K532.227.N56	G5 ø 5/8" G5 ø 7/8"	KG5.N56/X KG5.N140/X
RO23 RV23	FM 70	56 C 140 C	K533.227.N56 K533.227.N56	G6 ø 5/8" G6 ø 7/8"	KG6.N56/X KG6.N140/X
RO33 RV33	FM 85	56 C 140 TC	K534.227.N56 K534.227.N56	G6 ø 5/8" G6 ø 7/8"	KG6.N56/X KG6.N140/X
RO43 RV43	FM 110	56 C 140 TC 180 TC	K535.227.N56 K535.227.N56 K535.227.N180	G6 ø 5/8" G6 ø 7/8" G6 ø 1-1/8"	KG6.N56/X KG6.N140/X KG6.N180/X
RO53 RV53	FM 150	56 C 140 TC 180 TC	K537.227.N56 K537.227.N56 K537.227.N180	* GS8 ø 5/8" * GS8 ø 7/8" * GS8 ø 1-1/8"	KGS8.N56/X KGS8.N140/X KGS8.N180/X
RO63 RV63	FM 150	56 C 140 TC 180 TC 210 TC	K537.227.N56 K537.227.N56 K537.227.N180 K537.227.N180	* GS8 ø 5/8" * GS8 ø 7/8" * GS8 ø 1-1/8" * GS8 ø 1-3/8"	KGS8.N56/X KGS8.N140/X KGS8.N180/X KGS8.N210/X

\*\* - Giunto GS8: montaggio con chiavetta e grano di bloccaggio assiale  
 ../X - Codice del giunto con anello nero IXEF

\*\* - Coupling GS8: key fitting and axial locking grub screw  
 ../X - Code of coupling with IXEF black-spider

\*\* - Kupplung GS8: Keilmontage u. gewindestift  
 ../X - Kupplungscode mit schwarzen IXEF-Ring

### DESIGNAZIONE DEL RIDUTTORE - GEARBOX DESIGNATION - GETRIEBEBEZEICHNUNG

<b>F</b>	<b>RO</b>	<b>33</b>	<b>/B3</b>	<b>H</b>	<b>31.5</b>	<b>IEC80</b>	<b>-B5</b>	<b>AU30</b>	<b>DFU200</b>
									Flangia uscita $\varnothing$ - Output flange - Ausgangsflansch
									Albero uscita $\varnothing$ - Output shaft $\varnothing$ - Ausgangswelle $\varnothing$
									B5. B14 = Forma del motore - Motor form - Motorbauform
									Grandezza del motore elettrico - Electric motor frame - Motorbaugröße
									Rapporto di riduzione - Reduction ratio - Getriebeübersetzung
									H. V = Posizione di montaggio del riduttore - Gearbox mounting position - Einbaulage des Getriebes
									B3. B5. B3/B5 = Forma costruttiva del riduttore - Gearbox form - Bauform des Getriebes
									Grandezza e coppie del riduttore - Gearbox size and stages - Baugröße u. Stufen des Getriebes
									RO. RV = Tipo del riduttore - Gearbox type - Getriebetyp
M = Motoriduttore			- Geared motor			- Getriebemotor			
F = Riduttore con entrata IEC			- Gearbox with input flange			- Getriebe mit Eingangsflansch			
S = Riduttore senza flangia entrata IEC			- Gearbox without input flange			- Getriebe ohne Eingangsflansch			
... = (nulla) Riduttore con albero entrata sporgente			- (nothing) Gearbox with input free shaft			- (kein) Freie Eingangswelle			

### DESIGNAZIONE DEL MOTORE- MOTOR DESIGNATION - MOTORBEZEICHNUNG

<b>MT</b>	<b>0.75 kW</b>	<b>80 B</b>	<b>4</b>	<b>B5</b>	<b>230/400/50</b>	<b>IP55</b>	<b>F</b>	<b>X4</b>	
									Posizione della morsettiere Terminal box position Klemmkastenposition
									Classe F (std) = Classe isolamento Insulation class Isolationsklasse
									IP55 (std) = Grado di protezione - Protection class - Schutzart
									Tensione / Frequenza - Voltage/frequency - Spannung/Frequenz
									B5, B14 = Forma costruttiva - Mounting form - Bauform
									Numero poli - Number of poles - Polzahl
									Grandezza IEC del motore - IEC motor frame - IEC-Motorbaugröße
									Potenza del motore - Motor power - Motorleistung
MT = Motore trifase			- Three-phase motor			- Dreiphasenmotor			
MM = Motore monofase			- Single-phase motor			- Einphasenmotor			
MA = Motore autofrenante			- Brake motor			- Bremsmotor			



**Modularità e flessibilità**

Questa prerogativa ha guidato il progetto dei prodotti VARVEL a cominciare dagli anni 2000.

La disponibilità di riduttori in kit ha permesso il montaggio in pochi minuti utilizzando una normale attrezzatura.

Questo permette la massima flessibilità ai distributori e rivenditori VARVEL che, grazie ad un numero limitato di elementi, possono configurare all'istante il prodotto richiesto dai clienti.

Il programma di selezione **VARSIZE**® disponibile nel sito web

[www.varvel.com](http://www.varvel.com)

permette un facile dimensionamento dei prodotti VARVEL.

**Disegni 2D/3D**

Tramite configurazione assistita si generano modelli 3D e disegni 2D nei formati CAD più diffusi.

**Configurazione assistita**

Identifica, fra tutte le serie, i riduttori adeguati per soddisfare i parametri di funzionamento richiesti (potenza, coppia, velocità, fattore di servizio, ecc.).

Viene generato un documento PDF con dati prestazionali e disegni dimensionali per ciascuna configurazione rilasciati all'utente in formato 2D o 3D secondo richiesta

**Modularity and flexibility**

have been leading the design of VARVEL products since the years 2000: this way, the gearbox-kit concept was carried out allowing anyone to assemble the unit in few minutes with standard tooling.

This feature provides the highest flexibility to VARVEL's distributors and resellers who - thanks to a limited kit selection - are able to immediately configure the required product.

**VARSIZE**® selection program, available from our web-site

[www.varvel.com](http://www.varvel.com)

allows a friendly sizing of VARVEL product range.

**2D/3D Drawings**

A guided selection lets 2D/3D models downloaded for the most popular CAD systems.

**Guided selection**

This option returns a list of applicable product configurations upon a given sequence of application parameters (power, output torque, rpm, service factor etc.); a PDF data sheet featuring performance data and dimensional drawings is generated for each configuration, as well as the 3D model and 2D drawings.

**Bausteinprinzip und Flexibilität**

bestimmen die Gestaltung der VARVEL Produkte seit 2000. Dieses Konzept ermöglicht jedermann in kurzer Zeit mit Standardwerkzeugen das gewünschte Getriebe zu montieren.

Damit wird allen Verkäufern von VARVEL-antrieben ein Höchstmaß an Flexibilität gegeben, um mit wenigen Bauteilen ein gewünschtes Getriebe zu konfigurieren.

**VARSIZE**® als Auswahlprogramm auf unserer Internetseite

[www.varvel.com](http://www.varvel.com)

bietet eine angepasste Antriebsauslegung.

**2D/3D-Zeichnungen**

Die unterstützte Auswahl bietet die Möglichkeit 2D/3D Modelle für die gängigen CAD Systeme zu laden.

**Unterstützte Auswahl**

Mit diesem Dienst wird eine Liste möglicher Produktvarianten erzeugt, bestimmt durch Parameter (Leistung, Moment, Drehzahl, Betriebsfaktor usw.); ein PDF Datenblatt mit Leistungsdaten und Maßbild ist für jede dieser Konfigurationen verfügbar, ebenso wie 3D Modelle und 2D Zeichnungen.

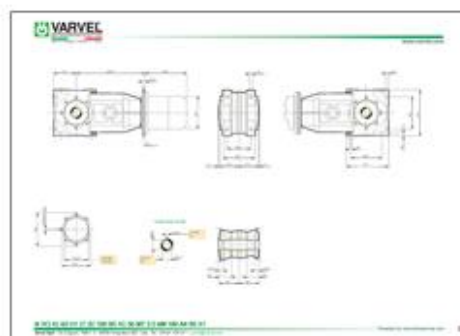

**RO**

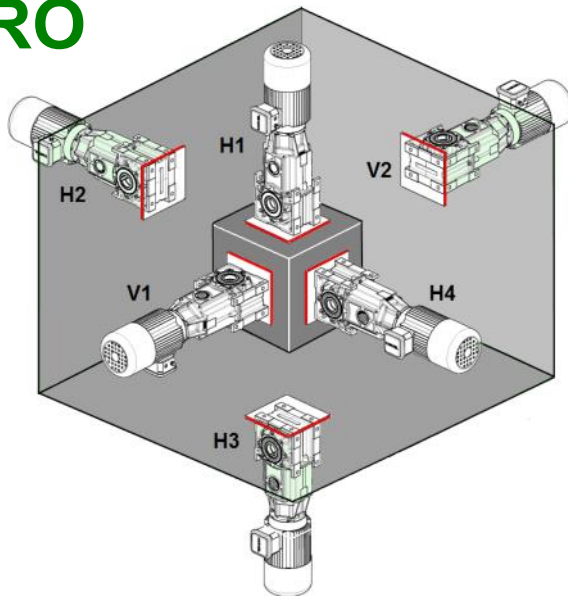

**B3**  
Montaggio a piedi  
Foot mounting  
Fußbauformen

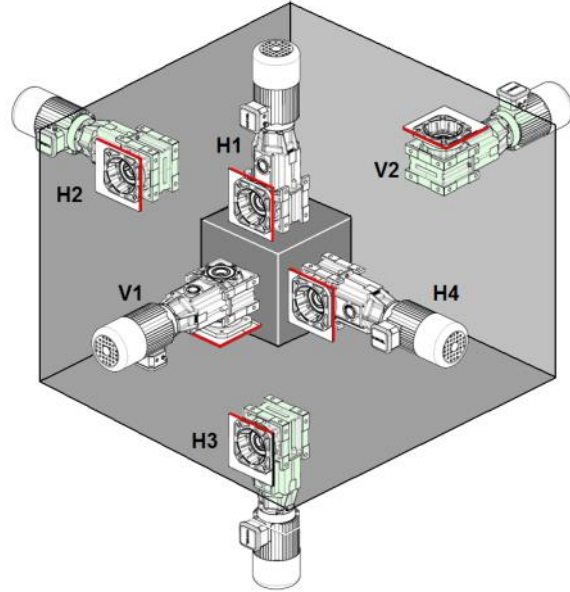

**B5**  
Montaggio a flangia  
Flange mounting  
Flanschbauformen

**RV**

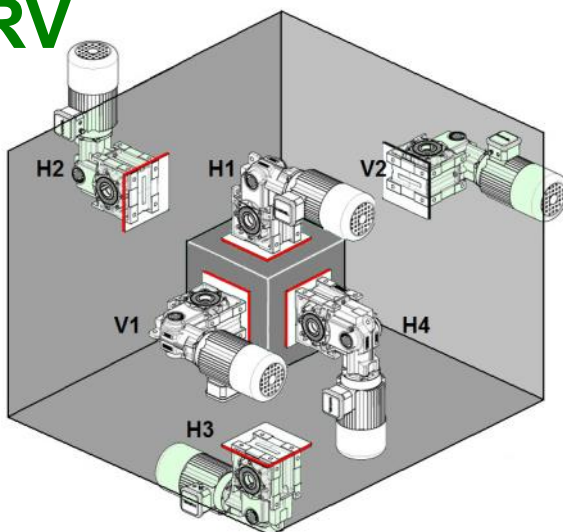

**B3**  
Montaggio a piedi  
Foot mounting  
Fußbauformen

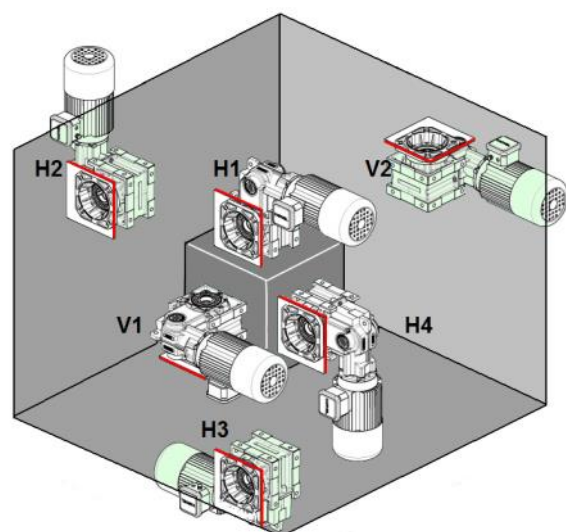

**B5**  
Montaggio a flangia  
Flange mounting  
Flanschbauformen

La posizione di montaggio è riferita all'albero di uscita e non al fissaggio con piedi o con flangia.

Mounting position is referred to the output shaft and not to foot or flange fixing.

Die Montageposition bezieht sich auf die Ausgangswelle und nicht der Fußbefestigungen oder Flansches.



**FATTORE DI SERVIZIO del riduttore**

Il fattore di servizio FS1.0 è inteso come rappresentativo di un funzionamento di 8 ore al giorno, con carico uniforme e fattore di accelerazione delle masse  $k_{(a)} \leq 0.2$ , avviamenti inferiori a 60 all'ora e temperatura ambiente fra 15 e 35 °C.

Il rapporto fra la coppia massima di uscita  $M_2$  del gruppo e la coppia richiesta dalla applicazione  $M_{(app)}$  determina il Fattore di Utilizzo del gruppo che deve essere uguale o superiore al fattore di servizio SF.

Non è necessario tener conto della potenza termica (v. pag.19) quando la durata massima di servizio continuativo è di circa 3 h seguita da pause sufficienti (circa 2 - 4 h) a ristabilire nel riduttore la temperatura ambiente.

Per temperatura massima ambiente maggiore di 40 °C oppure minore di 0 °C interpellare il Servizio Clienti.

**SERVICE FACTOR of the gearbox**

Service factor FS1.0 is meant as typical of 8 hours/day operation, with uniform load and mass acceleration factor  $k_{(a)} \leq 0.2$ , starts/stops lower than 60 per hour and ambient temperature between 15 and 35 Celsius.

The ratio between the drive's maximum output torque  $M_2$  and application torque  $M_{(app)}$  defines the drive's Duty Factor that must be equal or bigger than the Service Factor SF.

Thermal power (see page19) can be not considered when the max. continuous operation is about 3 hours with long enough rest periods (about 2 to 4 hours) to restore the ambient temperature into the gearbox.

For max. ambient temperature exceeding 40 °C or below 0 °C, please ask our Customer Service.

**BETRIEBSFAKTOR des Getriebes**

Für den Servicefaktor FS1.0 gilt ein 8- bis 10-stündiger Betrieb mit gleichförmiger Last und einem Massenbeschleunigungs Faktor  $k_{(a)} J_2 \leq 2$ , bis zu 60 Starts/Stops je Stunde und Umgebungstemperaturen zwischen 15° und 35 °C. Das Verhältnis zwischen dem maximalen Ausgangsdrehmoment des Getriebes  $M_2$  und des erfragtem Drehmoment der Anwendung  $M_{(app)}$ , bestimmt den Ausnutzungsfaktor der Gruppe, der gleich oder größer als der Betriebsfaktor SF sein muss. Abtriebsmoment des Getriebes  $M_2$  und dem erforderlichen Moment der Anwendung  $M_{(app)}$ . Thermische Leistung (siehe Seite 19) können nicht berücksichtigt, wenn die max. Dauerbetrieb etwa 3 Stunden lang genug Ruhezeiten (ca. 2 bis 4 Stunden), um die Umgebungstemperatur in dem Getriebe wiederherzustellen. Für max. Umgebungstemperatur über 40° C oder unter 0° C, fragen Sie bitte unseren Kundenservice.

**Fattore di Servizio SF - Service Factor SF - Betriebsfaktor SF**

Tipo di Carico - Charge type - Belastung-Typ				Avviamenti / Ora Start-Stops / Hour Schaltungen/Stunde		SF = SF <sub>1</sub> x SF <sub>2</sub>
ore hours Stunden	uniforme gleichmäßige SF <sub>1</sub>	variabile variabel SF <sub>1</sub>	a urti with shocks mit Stöße SF <sub>1</sub>	numero number Anzahl	SF <sub>2</sub>	
8	0.8	1.1	1.4	60	1.0	
16	1.0	1.3	1.5	600	1.2	
24	1.2	1.4	1.6	1200	1.3	

**Fattore di accelerazione delle masse  
Mass acceleration factor  
Beschleunigungsfaktor der Massen**

$$k_{(a)} = \frac{J_2}{J_m} + J_1$$

Classi di carico  
Load class  
Belastungsklassen

- A - Carico uniforme  
Uniform load  $k_{(a)} \leq 0.2$   
Gleichförmige Last
- B - Carico con urti moderati  
Moderate shock load  $0.2 < k_{(a)} \leq 3$   
Ungleichförmige Last
- C - Carico con forti urti  
Severe shock load  $3 < k_{(a)} \leq 10$   
Stark ungleichförmige Last

A/h - Numero di avviamenti/ora  
Number of starts/stops per hour  
Anzahl der Schaltungen je Stunde

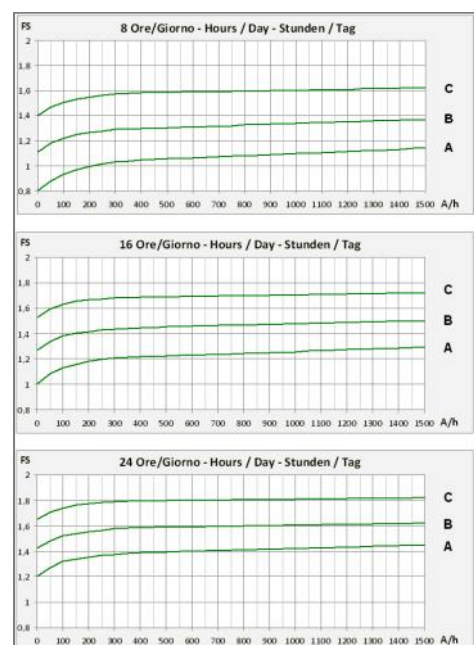

<b>TIPO DI SERVIZIO del motore</b> Le specifiche dei vari tipi di servizi sono definiti dalle norme CEIEN60034-1/IEC34-1.	<b>DUTY TYPE of the motor</b> Duty types are defined by CEI EN 60034-1 / IEC34-1 Standard.	<b>BETRIEBSARTEN des Motors</b> Die Betriebsarten sind definiert in den Normen CEI EN 60034-1 / IEC34-1.
<p><b>S1 - Servizio continuo</b>                      Funzionamento a carico costante per un periodo di tempo indefinito (N), comunque sufficiente a raggiungere l'equilibrio termico.                      In servizio continuo, possono essere utilizzati i riduttori che nelle tabelle di selezione hanno un fattore di servizio SF1.0 o superiore.</p>	<p><b>S1 - Continuous duty</b>                      Steady load operation for an indefinite period (N), but long enough to achieve thermal balancing.                      On continuous duty, the gearboxes with selection table service factor SF1.0 or higher can be accordingly used.</p>	<p><b>S1 - Dauerbetrieb</b>                      Betrieb mit konstanter Belastung über eine unbestimmte Zeit (N), ohne dass der thermische Beharrungszustand der Maschine beeinträchtigt wird. Im Dauerbetrieb können Getriebe eingesetzt werden, die in den Auswahltabellen einen Betriebsfaktor SF1.0 oder höher aufweisen.</p>
<p><b>S3 - Servizio intermittente periodico</b>                      Funzionamento secondo un ciclo (C) comprendente un periodo di tempo a carico costante (N) ed un periodo di tempo di riposo (R). Gli avviamenti non influiscono sulle temperature. Il ciclo (C) di riferimento è di 10 minuti complessivi.                      In servizio intermittente periodico, possono essere utilizzati i riduttori che nelle tabelle di selezione hanno un fattore di servizio SF pari al rapporto di intermittenza.                      Il rapporto di intermittenza viene determinato secondo la formula seguente.</p>	<p><b>S3 - Periodic intermittent duty</b>                      Operation according to cycle (C) including steady load time (N) and rest time (R). Starts/stops do not affect temperature. The reference cycle (C) is up to a total of 10 minutes.                      On periodic intermittent duty, the gearboxes with selection table service factor matching the intermittence ratio service factor can be accordingly used.                      Intermittence ratio is calculated according the following formula.</p>	<p><b>S3 - Aussetzbetriebe</b>                      Betrieb als Folge (C) gleichartiger Spiele mit konstanter Last während der Zeit (N) und einer folgenden Pause (R). Starten/Anhalten beeinflussen nicht die Temperatur. Für die Zyklusdauer (C) gilt eine Zeit von 10 Minuten.                      Im periodischen Intervallbetrieb können Getriebe verwendet werden, die in den Auswahltabellen einen Betriebsfaktor von SF haben, der gleich dem Intermittenzverhältnis ist. Die Intermittenzübersetzung wird nach die folgende Formel bestimmt.</p>
$\frac{N}{(N+R)} * 100 = \begin{matrix} 60\% & \text{FS } 0.9 \\ 40\% & \text{FS } 0.85 \\ 25\% & \text{FS } 0.75 \\ 15\% & \text{FS } 0.7 \end{matrix}$	<p>N = Tempo di lavoro                      Operation time                      Betriebsdauer</p> <p>R = Tempo di riposo                      Rest time                      Pause</p> <p>C = Ciclo di lavoro                      Duty cycle                      Zyklusdauer</p>	

**CARICHI RADIALI USCITA**

Il carico radiale ( $F_r$ ) riportato nelle tabelle, deve essere verificato in base alla velocità di uscita, alla posizione di montaggio (A) e al tipo di elemento di trasmissione (B) montato sull'albero di uscita del riduttore tramite i relativi fattori  $k_L$  e  $k_T$ .

**OUTPUT RADIAL LOADS (OHL)**

The radial (overhung) load shown in the tables, should be checked according to output speed, mounting position (A) and type of the transmission element (B) fitted on the gearbox output shaft by the appropriate  $k_L$  and  $k_T$  rating factors.

**AUSGANGSRADIALKRÄFTE**

Die Radialkräfte in den Tabellen müssen mit entsprechender Abtriebsdrehzahl, der Montageposition (A) und dem Übertragungselement (B) montiert auf der Getriebe-Ausgangswelle durch entsprechendem Faktoren  $k_L$  und  $k_T$  verglichen werden.

**A - Punto di applicazione del carico radiale - Application point of radial load - Anwendung Punkt der Radialbelastung**

Il carico radiale è considerato applicato alla mezzeria dell'albero di uscita. Altre posizioni originano carichi da correggere con l'appropriato fattore  $k_L$ . Esempi della distanza da spallamento dell'albero:

OHL is considered as applied at the output shaft mid-point. Other positions origin loads to be adjusted with the appropriate factor  $k_L$ . Examples of the distance from the shaft shoulder:

Die Radialbelastung wird auf der Mitte der Ausgangswelle angelegt. Andere Positionen erzeugen Lasten, die mit dem entsprechendem Faktor  $k_L$  zu korrigieren sind. Beispiele für den Abstand der Stufenwelle:

$k_L$	L
1.1	1/4 * L
1.0	1/2 * L
0.9	3/4 * L
0.8	L

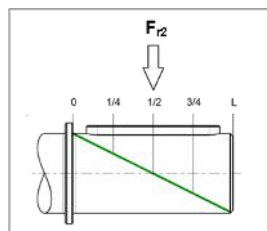

**B - Elemento della trasmissione - Transmission element - Übertragungselement**

$k_T$	Tipo dell'elemento	Element type	Elementtyp
1,15	Ingranaggio n. denti < 17	Gear tooth No. < 17	Zahnrad Zähnezahl < 17
1,40	Pignone catena n. denti < 13	Chain sprocket tooth No. < 13	Kettenrad Zähnezahl < 13
1,25	n. denti < 20	tooth No. < 20	Zähnezahl < 20
1,00	n. denti > 20	tooth No. > 20	Zähnezahl > 20
2,50	Puleggia per cinghie "V"	Pulley for V-belt	Riemen für Keilriemen "V"
1,25	cinghie dentate	toothed-belt	Zahnriemen

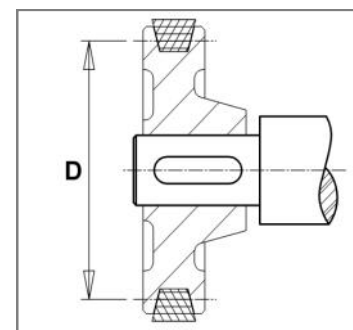

**$F_{r2}$  - Carico radiale - Radial (overhung) load - Radialkräfte**

$$F_{r2} = \frac{2000 * M_2}{D} \times k_L \times k_T$$

**CARICHI ASSIALI USCITA**

$F_{a2}$  - Il valore del carico assiale  
 $F_{a2} = F_{r2} \times 0.2$   
è incluso nel valore dei carichi radiali di catalogo ed è valido sia a trazione che a compressione.

**OUTPUT AXIAL LOADS**

$F_{a2}$  - Axial load value  
 $F_{a2} = F_{r2} \times 0.2$   
is included within the catalogue radial load figure and is valid on both tensile and compressive stress.

**AUSGANGSAXIALKRÄFTE**

$F_{a2}$  - Der Wert der Axialkräfte  
 $F_{a2} = F_{r2} \times 0.2$   
ist in dem Wert der Radialkräfte des Kataloges enthalten und gilt sowohl in Zug und Druck.

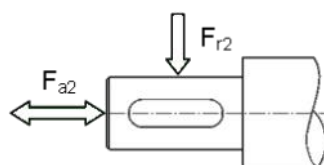

### MRO - MRV

- Motoriduttori a tre coppie di ingranaggi  
Potenza: 0.06 kW a 22 kW a 4 poli  
Giri uscita: 215 rpm a 4.0 rpm
- Geared motors with three gear sets  
Powers: 0.09 kW to 22 kW. 4 poles  
Output speed: 215 rpm to 4.0 rpm
- Dreistufig Getriebemotoren  
Leistung: 0.09 kW bis 22 kW. 4-polen  
Ausgangsgeschwindigkeit: 215 UpM bis 4.0 UpM

### FRO - FRV

- Riduttori a tre coppie di ingranaggi con flangia motore entrata  
Flange motore: IEC 56 a IEC 180 e NEMA 56C a NEMA 210TC  
Coppia: 180 Nm a 3400 Nm  
Rapporti di riduzione: 6.3:1 a 315:1
- Gearboxes with three gear sets and with input motor flange  
Motor flanges: IEC 56 to IEC 180 and NEMA 56C to NEMA 210TC  
Output torque: 180 Nm [1060 in-lb] to 3400 Nm [30100 in-lb]  
Reduction ratios: 6.3:1 to 315:1
- Dreistufig Getriebemotoren mit Motorflansch  
Motorflansche: IEC 56 bis IEC 180 u. NEMA 56C bis NEMA 210TC  
Ausgangsdrehmoment: 180 Nm [1060 in-lb] bis 3400 Nm [30100 in-lb]  
Untersetzungsverhältnis: 6.3:1 bis 315:1

### SRO - SRV

- Riduttori a tre coppie di ingranaggi senza flangia motore entrata  
ma con albero entrata cavo con giunto  
Coppia: 180 Nm [1060 in-lb] a 3400 Nm [30100 in-lb]  
Rapporti di riduzione: 6.3:1 a 315:1
- Gearboxes with three gear sets without input motor flange  
but with input hollow shaft with flexible coupling  
Output torque: 180 Nm [1060 in-lb] to 3400 Nm [30100 in-lb]  
Reduction ratios: 6.3:1 to 315:1
- Dreistufig Getriebemotoren ohne Motorflansch  
aber. Hohleingangswelle mit Kupplung  
Ausgangsdrehmoment: 180 Nm [1060 in-lb] bis 3400 Nm [30100 in-lb]  
Untersetzungsverhältnis: 6.3:1 bis 315:1

### RO - RV

- Riduttori a tre coppie di ingranaggi con albero entrata sporgente  
Coppia: 120 Nm [1060 in-lb] a 3400 Nm [30100 in-lb]  
Rapporti di riduzione: 6.3:1 a 710:1
- Gearboxes with three gear sets with input solid shaft  
Output torque: 120 Nm [1060 in-lb] to 3400 Nm [30100 in-lb]  
Reduction ratios: 6.3:1 to 710:1
- Dreistufig Getriebemotoren mit Eingangsfreiwelle  
Ausgangsdrehmoment: 120 Nm [1060 in-lb] bis 3400 Nm [30100 in-lb]  
Untersetzungsverhältnis: 6.3:1 bis 710:1



Serie RO - Versione in linea  
Serie RV - Versione a squadra

RO Series - In-line version  
RV Series - Right angle version

Reihe RO - Inlineausführung  
Reihe RV - Winkelausführung

**Potenza termica**

La **potenza nominale**  $P_1$ , è la potenza che può essere applicata all'entrata del riduttore. in servizio continuo. temperatura max ambiente di 40 °C. altitudine max 1000 m e velocità dell'aria 1.25 m/s. senza superare una temperatura dell'olio di circa 85 °C.

La **potenza termica**  $P_{t1}$  può limitare la nominale  $P_1$  (area in grigio) in funzione del sistema di raffreddamento. della velocità di entrata. della temperatura ambiente e del coefficiente di servizio.

**Thermal power**

The **rated power**  $P_1$ , is the power that can be applied at the gearbox input. on continuous operation. max. temperature of 40 °C . max. altitude 1000 m. air speed of 1.25 m/s. without exceeding the oil temperature of about 85 °C.

The **thermal power**  $P_{t1}$  can limit the rated  $P_1$  depending on the cooling system. input speed. ambient temperature and service factor.

**Thermische Leistung**

Die **Nennleistung**  $P_1$  ist die Leistung. die am Getriebe angewendet werden kann. Dauerbetriebstemperatur von 40 °C max.. max. Höhe 1000 m. Luftgeschwindigkeit von 1.25 m/s. ohne mehr als eine Temperatur von Öl von etwa 85 °C.

Die **thermische Leistung**  $P_{t1}$  kann der Nennleistung  $P_1$  als Funktion des Kühlsystems der Antriebsdrehzahl. Umgebungstemperatur und der Koeffizient der Service begrenzen.

$i_n$	FRO13 FRV13		FRO23 FRV23		FRO33 FRV33		FRO43 FRV43		FRO53 FRV53		FRO63 FRV63	
	$P_1$ [kW]	$P_{t1}$ [kW]	$P_1$ [kW]	$P_{t1}$ [kW]	$P_1$ [kW]	$P_{t1}$ [kW]	$P_1$ [kW]	$P_{t1}$ [kW]	$P_1$ [kW]	$P_{t1}$ [kW]	$P_1$ [kW]	$P_{t1}$ [kW]
6,3	---	---	4,70	5,40	10,20	7,04	11,10	9,49	22,40	16,43	40,30	22,32
7,1	2,70	3,08	---	---	---	---	---	---	---	---	---	---
8	---	---	4,10	5,11	8,50	6,68	9,90	9,01	20,00	15,40	31,90	21,56
9,0	2,20	3,11	3,90	4,28	6,50	6,22	11,60	7,07	---	---	---	---
10,0	2,30	3,01	3,70	4,85	7,70	6,33	9,10	8,51	17,60	14,37	28,50	20,46
11,2	2,00	2,90	3,10	4,12	5,10	5,98	9,20	6,68	---	---	---	---
12,5	---	---	3,30	4,56	6,60	5,98	7,90	7,98	16,60	13,45	25,70	19,19
14,0	1,50	2,92	2,50	3,93	5,30	5,26	5,80	7,99	12,00	12,43	18,90	17,80
16,0	1,70	2,68	2,90	4,20	5,20	5,53	7,00	7,53	14,10	12,65	22,60	17,91
18,0	1,20	2,70	2,20	3,89	4,60	5,07	5,40	7,64	10,80	11,87	17,00	17,01
20,0	1,40	2,47	2,40	3,95	3,20	4,84	6,00	6,97	12,20	11,48	19,40	16,44
22,4	1,10	2,27	1,90	3,72	4,00	4,93	4,90	7,30	9,70	11,30	15,40	16,36
25,0	0,96	2,27	1,90	3,41	3,30	4,63	5,00	6,21	9,70	10,20	14,10	15,21
28,0	0,91	2,06	1,80	3,54	2,20	4,15	4,30	6,83	8,80	10,76	13,90	15,57
31,5	0,81	2,13	1,20	3,22	2,60	4,23	4,30	5,81	8,30	10,13	14,00	14,11
35,5	0,66	1,75	1,40	3,32	2,50	4,35	3,90	6,45	7,70	10,14	12,40	14,77
40	0,68	2,00	1,20	3,08	2,20	4,01	---	---	6,40	9,41	10,80	13,62
45	0,55	1,87	1,10	3,18	2,00	3,97	3,10	6,00	6,20	9,26	9,20	11,88
50	0,56	1,84	0,92	2,89	1,80	3,79	3,00	6,12	5,20	8,95	10,30	12,88
56	0,37	1,85	0,88	2,80	1,70	3,72	2,80	5,40	4,80	8,38	9,30	12,13
63	0,43	1,69	0,74	2,77	1,00	3,70	2,40	5,67	4,20	8,27	8,10	12,01
71	0,36	1,64	0,60	2,57	1,30	3,48	2,10	5,10	3,60	8,05	6,90	11,36
80	0,30	1,59	0,59	2,48	1,10	3,29	1,90	5,10	2,50	8,25	6,20	10,88
90	0,30	1,51	0,53	2,48	0,70	3,08	1,60	5,39	3,00	6,83	5,80	10,67
100	0,27	1,48	0,39	2,36	0,86	3,11	1,40	4,83	2,80	7,54	5,20	10,66
112	0,21	1,51	0,42	2,23	0,80	2,92	1,40	4,85	2,40	7,25	4,40	9,73
125	0,22	1,38	0,33	2,16	0,60	2,88	1,00	3,68	2,30	6,73	3,00	9,84
140	0,18	1,26	0,28	2,13	0,61	2,77	1,00	4,58	2,00	6,74	3,70	9,55
160	0,16	1,21	0,26	1,97	0,41	2,59	0,71	3,65	1,80	6,49	3,40	9,19
180	0,13	1,15	0,24	1,90	0,43	2,58	0,67	3,49	1,20	6,03	2,20	8,40
200	0,12	1,21	0,20	1,88	0,32	2,63	0,61	3,75	1,00	6,07	---	---
224	0,10	1,15	0,17	1,74	---	---	0,51	3,48	0,92	5,62	1,80	8,54
250	0,09	1,10	0,16	1,65	0,27	2,45	0,46	3,32	0,82	5,66	---	---
280	---	---	---	---	0,25	2,36	0,41	3,14	---	---	1,50	7,85
315	0,06	0,99	0,13	1,55	0,20	2,14	---	---	0,66	5,12	1,30	7,36

**RO1/RV1 - 180 Nm - 1400 rpm**

	$i_n$	$i_r$	$n_2$ [rpm]	$M_2$ [Nm]	$P_1$ [kW]	$F_{r1}$ [N]	$F_{r2}$ [N]	$J_1$ ( $\times 10^{-4}$ ) [kgm <sup>2</sup> ]	56 B5	63 B*	71 B*	80 B*	90 B*
<b>FRO13</b>	7.1	7.58	185	130	2.7	1550	3310	1.1700	⊙	⊙	⊙	⊙	⊙
<b>FRV13</b>	9.0	9.14	153	130	2.2	1580	3740	1.0754	⊙	⊙	⊙	⊙	⊙
<b>3c</b>	10.0	9.57	146	140	2.3	1580	3600	1.0469	⊙	⊙	⊙	⊙	⊙
	11.2	11.63	120	150	2.0	1590	3570	0.9761	⊙	⊙	⊙	⊙	⊙
	14.0	14.02	100	130	1.5	1600	4040	0.9358	⊙	⊙	⊙	⊙	⊙
	16.0	15.14	92.5	165	1.7	1600	3550	0.9105	⊙	⊙	⊙	⊙	⊙
	18.0	18.25	76.7	135	1.2	1610	4240	0.8868	⊙	⊙	⊙	⊙	⊙
	20.0	19.15	73.1	170	1.4	1610	3670	0.8712	⊙	⊙	⊙	⊙	⊙
	22.4	23.33	60.0	170	1.1	1610	3820	0.8476	⊙	⊙	⊙	⊙	⊙
	25.0	24.44	57.3	150	0.96	1600	4150	0.3567	⊙	⊙	⊙	⊙	
	28.0	29.18	48.0	170	0.91	1610	3960	0.8281	⊙	⊙	⊙	⊙	
	31.5	31.82	44.0	165	0.81	1600	4120	0.3418	⊙	⊙	⊙	⊙	
	35.5	37.95	36.9	160	0.66	1610	4430	0.8125	⊙	⊙	⊙	⊙	
	40	40.25	34.8	175	0.68	1610	4100	0.3329	⊙	⊙	⊙	⊙	
	45	47.88	29.2	170	0.55	1600	4300	0.2717	⊙	⊙	⊙	⊙	
	50	49.02	28.6	175	0.56	1610	4100	0.3276	⊙	⊙	⊙	⊙	
	56	59.10	23.7	140	0.37	1610	4820	0.3253	⊙	⊙	⊙		
	63	61.31	22.8	170	0.43	1610	4000	0.3231	⊙	⊙	⊙		
	71	73.77	19.0	170	0.36	1610	4000	0.2654	⊙	⊙	⊙		
	80	84.93	16.5	165	0.30	1610	4400	0.2441	⊙	⊙	⊙		
	90	92.26	15.2	180	0.30	1610	4000	0.2634	⊙	⊙	⊙		
	100	103.46	13.5	180	0.27	1610	4000	0.2429	⊙	⊙	⊙		
	112	111.22	12.6	150	0.21	1610	4800	0.2628	⊙	⊙			
	125	129.39	10.8	180	0.22	1610	4000	0.2419	⊙	⊙			
	140	132.61	10.6	150	0.18	1610	4700	0.2614	⊙	⊙			
	160	168.30	8.32	175	0.16	1610	4100	0.2411	⊙	⊙			
	180	185.98	7.53	150	0.13	1610	4700	0.2409	⊙	⊙			
	200	202.90	6.90	150	0.12	1610	4800	0.2408	⊙				
	224	224.22	6.24	150	0.10	1610	4800	0.2407	⊙				
	250	249.80	5.60	150	0.09	1610	4800	0.2405	⊙				
	315	320.513	4.37	130	0.06	1360	4800	0.2320	⊙				

**B\*** = B5 & B14

**3c** - Numero delle coppie di riduzione

**B\*** = B5 & B14

**3c** - Number of reduction stages

**B\*** = B5 & B14

**3c** - Anzahl der Getriebestufen

	Olio [ litri ] - Oil [ litres ] - Öl [ Liter ]						Weight [ kg ]
	H1	H2	H3	H4	V1	V2	
FRO13	0.5	0.45	0.4	0.45	0.35	0.45	6.4
FRV13	0.5	0.35	0.25	0.35	0.4	0.3	6.1

**RO2/RV2 - 310 Nm - 1400 rpm**

	$i_n$	$i_r$	$n_2$ [rpm]	$M_2$ [Nm]	$P_1$ [kW]	$F_{r1}$ [N]	$F_{r2}$ [N]	$J_1 (x 10^{-4})$ [kgm <sup>2</sup> ]	71 B*	80 B*	90 B*	100 B*	112 B*
<b>FRO23</b>	6.3	6.62	211.4	200	4.7	2900	3350	3.7230	⊙	⊙	⊙	⊙	⊙
<b>FRV23</b>	8.0	8.47	165.3	220	4.1	2900	3620	3.4225	⊙	⊙	⊙	⊙	⊙
<b>3c</b>	9.0	8.97	156.0	225	3.9	2900	3710	3.4623	⊙	⊙	⊙	⊙	
	10.0	10.43	134.3	245	3.7	2900	3870	3.2499	⊙	⊙	⊙	⊙	
	11.2	11.48	122.0	230	3.1	3000	4040	3.2632	⊙	⊙	⊙	⊙	
	12.5	13.03	107.4	275	3.3	3000	3920	3.1175	⊙	⊙	⊙	⊙	
	14.0	14.13	99.1	230	2.5	3000	4340	3.1448	⊙	⊙	⊙	⊙	
	16.0	16.68	83.9	305	2.9	3000	3620	3.0140	⊙	⊙	⊙	⊙	
	18.0	17.80	78.6	250	2.2	3000	4480	1.3623	⊙	⊙	⊙	⊙	
	20.0	20.55	68.1	310	2.4	3000	3720	2.9511	⊙	⊙	⊙	⊙	
	22.4	21.91	63.9	270	1.9	3000	4420	1.3232	⊙	⊙	⊙		
	25.0	26.07	53.7	310	1.9	3000	3930	2.8990	⊙	⊙	⊙		
	28.0	27.39	51.1	310	1.8	3000	4180	1.2932	⊙	⊙	⊙		
	31.5	32.97	42.5	260	1.2	3000	4960	1.0795	⊙	⊙	⊙		
	35.5	35.06	39.9	310	1.4	3000	4220	1.2698	⊙	⊙	⊙		
	40	41.21	34.0	310	1.2	3000	4600	1.0662	⊙	⊙	⊙		
	45	43.18	32.4	310	1.1	3000	4450	1.2555	⊙	⊙	⊙		
	50	52.75	26.5	310	0.92	3000	4680	1.0559	⊙	⊙			
	56	54.78	25.6	310	0.88	3000	4720	1.2437	⊙	⊙			
	63	64.97	21.5	310	0.74	3000	4930	1.0496	⊙	⊙			
	71	73.98	18.9	285	0.60	3000	5510	0.9764	⊙	⊙			
	80	82.42	17.0	310	0.59	3000	5100	1.0444	⊙	⊙			
	90	91.12	15.4	310	0.53	3000	5100	0.9732	⊙				
	100	106.60	13.1	270	0.39	3000	6000	1.0405	⊙				
	112	115.60	12.1	310	0.42	3000	5100	0.9706	⊙				
	125	123.47	11.34	260	0.33	3000	6200	0.9721	⊙				
	140	149.51	9.36	270	0.28	3000	6000	0.9686	⊙				
	160	156.64	8.94	260	0.26	3000	6200	0.9699	⊙				
	180	170.11	8.23	260	0.24	3000	6200	1.0381	(⊙)				
	200	202.59	6.91	260	0.20	3000	6200	0.9682	(⊙)				
	224	238.58	5.87	260	0.17	3000	6200	0.9674	(⊙)				
	250	261.07	5.363	260	0.16	3000	6200	0.9670	(⊙)				
	315	319.55	4.381	260	0.13	3000	6200	0.9664	(⊙)				

**B\* = B5 & B14**
**3c** - Numero delle coppie di riduzione

(⊙) - Potenza max utilizzabile  $\leq P_1$ 
**B\* = B5 & B14**
**3c** - Number of reduction stages

(⊙) - Max. available power  $\leq P_1$ 
**B\* = B5 & B14**
**3c** - Anzahl der Getriebestufen

(⊙) - Max. Leistung  $\leq P_1$ 

	Olio [ litri ] - Oil [ litres ] - Öl [ Liter ]						Weight [ kg ]
	H1	H2	H3	H4	V1	V2	
FRO23	0.8	0.7	0.75	0.7	0.85	0.85	10.6
FRV23	0.65	0.6	0.5	0.6	0.7	0.55	10.1

**RO3/RV3 - 580 Nm - 1400 rpm**

	$i_n$	$i_r$	$n_2$ [rpm]	$M_2$ [Nm]	$P_1$ [kW]	$F_{r1}$ [N]	$F_{r2}$ [N]	$J_1 (x 10^{-4})$ [kgm <sup>2</sup> ]	71 B*	80 B*	90 B*	100 B*	112 B*
<b>FRO33</b>	6.3	6.43	217.6	420	10.2	4550	4990	7.8449	⊙	⊙	⊙	⊙	⊙
<b>FRV33</b>	8.0	8.25	169.7	450	8.5	5540	5430	7.0546	⊙	⊙	⊙	⊙	⊙
<b>3c</b>	9.0	9.09	154.0	380	6.5	5710	5680	7.1141	⊙	⊙	⊙	⊙	⊙
	10.0	10.17	137.7	500	7.7	5630	4980	6.5966	⊙	⊙	⊙	⊙	⊙
	11.2	11.65	120.2	380	5.1	5730	6180	6.6099	⊙	⊙	⊙	⊙	⊙
	12.5	12.72	110.0	540	6.6	5710	4640	6.2405	⊙	⊙	⊙	⊙	⊙
	14.0	13.52	103.5	460	5.3	5520	5970	2.2602	⊙	⊙	⊙	⊙	⊙
	16.0	16.30	85.9	540	5.2	5730	4800	5.9573	⊙	⊙	⊙	⊙	⊙
	18.0	17.33	80.8	510	4.6	5680	5460	2.0812	⊙	⊙	⊙	⊙	⊙
	20.0	19.10	73.3	390	3.2	5730	7310	2.0993	⊙	⊙	⊙	⊙	
	22.4	21.67	64.6	550	4.0	5740	4970	5.7302	⊙	⊙	⊙	⊙	
	25.0	26.73	52.4	560	3.3	5730	5130	1.8969	⊙	⊙	⊙	⊙	
	28.0	28.74	48.7	400	2.2	5740	7800	1.4638	⊙	⊙	⊙	⊙	
	31.5	33.27	42.1	550	2.6	5740	4800	5.5211	⊙	⊙	⊙	⊙	
	35.5	34.26	40.9	560	2.5	5740	5370	1.8327	⊙	⊙	⊙	⊙	
	40	40.23	34.8	570	2.2	5740	5500	1.3744	⊙	⊙	⊙	⊙	
	45	45.54	30.7	570	2.0	5740	5580	1.7813	⊙	⊙	⊙		
	50	51.55	27.2	580	1.8	5740	5600	1.3460	⊙	⊙	⊙		
	56	53.60	26.1	580	1.7	5740	5600	1.7597	⊙	⊙	⊙		
	63	64.33	21.8	410	1.0	5740	8950	1.7667	⊙	⊙	⊙		
	71	68.52	20.4	580	1.3	5740	5500	1.3233	⊙	⊙	⊙		
	80	80.65	17.4	580	1.1	5740	5500	1.3138	⊙	⊙	⊙		
	90	91.94	15.2	410	0.70	5740	9580	1.7158	⊙	⊙			
	100	105.20	13.3	580	0.86	5750	5500	1.3024	⊙	⊙			
	112	113.11	12.4	580	0.80	5740	5500	1.1546	⊙	⊙			
	125	125.46	11.16	480	0.60	5740	8500	1.2969	⊙	⊙			
	140	147.54	9.49	580	0.61	5740	5500	1.1488	⊙	⊙			
	160	162.17	8.63	430	0.41	5740	9400	1.7036	⊙				
	180	175.95	7.96	490	0.43	5740	8200	1.1460	⊙				
	200	208.42	6.72	430	0.32	5740	9400	1.1474	⊙				
	250	248.56	5.63	430	0.27	5740	9400	1.1450	⊙				
	280	274.11	5.107	430	0.25	5740	9400	1.1439	⊙				
	315	342.23	4.091	430	0.20	5740	9400	1.1420	(⊙)				

**B\*** = B5 & B14

**3c** - Numero delle coppie di riduzione

(⊙) - Potenza max utilizzabile  $\leq P_1$ 
**B\*** = B5 & B14

**3c** - Number of reduction stages

(⊙) - Max. available power  $\leq P_1$ 
**B\*** = B5 & B14

**3c** - Anzahl der Getriebestufen

(⊙) - Max. Leistung  $\leq P_1$ 

	Olio [ litri ] - Oil [ litres ] - Öl [ Liter ]						Weight [ kg ]
	H1	H2	H3	H4	V1	V2	
FRO33	1.5	1.2	1.4	1.2	1.5	1.7	12.5
FRV33	1.5	1.0	0.8	1.0	1.2	0.8	13.0



**RO4/RV4 - 1000 Nm - 1400 rpm**

	$i_n$	$i_r$	$n_2$ [rpm]	$M_2$ [Nm]	$P_1$ [kW]	$F_{r1}$ [N]	$F_{r2}$ [N]	$J_1$ ( $\times 10^{-4}$ ) [kgm <sup>2</sup> ]	71 B5	80 B5	90 B5	100 B*	112 B*
<b>FRO43</b>	6.3	6.60	212.1	470	11.1	5670	5570	18.0401	⊙	⊙	⊙	⊙	⊙
<b>FRV43</b>	8.0	8.35	167.6	530	9.9	5740	6000	16.3029	⊙	⊙	⊙	⊙	⊙
<b>3c</b>	9.0	8.72	160.6	650	11.6	5560	5980	16.5334	⊙	⊙	⊙	⊙	⊙
	10.0	10.43	134.2	610	9.1	5770	6430	15.1392	⊙	⊙	⊙	⊙	⊙
	11.2	11.04	126.8	650	9.2	5740	6520	15.3615	⊙	⊙	⊙	⊙	⊙
	12.5	13.29	105.4	670	7.9	5780	6950	14.2633	⊙	⊙	⊙	⊙	⊙
	14.0	13.87	100.9	515	5.8	5630	7190	6.3637	⊙	⊙	⊙	⊙	⊙
	16.0	16.21	86.4	730	7.0	5780	7420	13.7425	⊙	⊙	⊙	⊙	⊙
	18.0	17.55	79.8	610	5.4	5700	7740	5.9704	⊙	⊙	⊙	⊙	⊙
	20.0	20.22	69.2	780	6.0	5780	7980	13.3129	⊙	⊙	⊙	⊙	⊙
	22.4	21.94	63.8	690	4.9	5740	8310	5.7069	⊙	⊙	⊙	⊙	⊙
	25.0	26.10	53.6	840	5.0	5780	8690	12.9609	⊙	⊙	⊙	⊙	⊙
	28.0	27.92	50.1	770	4.3	5780	8990	5.5085	⊙	⊙	⊙	⊙	⊙
	31.5	32.52	43.1	890	4.3	5790	9390	12.7520	⊙	⊙	⊙	⊙	⊙
	35.5	34.06	41.1	840	3.9	5780	9580	5.3906	⊙	⊙	⊙	⊙	
	45	42.50	32.9	840	3.1	5780	10020	5.2933	⊙	⊙	⊙	⊙	
	50	51.25	27.3	980	3.0	5780	9720	4.3723	⊙	⊙	⊙	⊙	
	56	54.84	25.5	980	2.8	5790	9800	5.2136	⊙	⊙	⊙	⊙	
	63	63.95	21.9	990	2.4	5780	10090	4.3293	⊙	⊙	⊙	⊙	
	71	68.34	20.5	920	2.1	5790	10970	5.1663	⊙	⊙	⊙		
	80	82.52	17.0	1000	1.9	5790	10510	4.2941	⊙	⊙	⊙		
	90	89.69	15.6	890	1.6	5790	11880	3.9791	⊙	⊙	⊙		
	100	102.83	13.6	940	1.4	5790	11740	4.2732	⊙	⊙	⊙		
	112	115.73	12.1	1020	1.4	5790	11130	3.9612	⊙	⊙	⊙		
	125	121.80	11.5	780	1.0	5790	13730	5.1136	⊙	⊙			
	140	144.22	9.71	950	1.0	5790	12410	3.9506	⊙	⊙			
	160	164.63	8.50	750	0.71	5790	14400	4.2552	⊙	⊙			
	180	183.27	7.64	790	0.67	5790	14710	4.2500	⊙	⊙			
	200	190.66	7.34	750	0.61	5790	14830	3.9474	⊙	⊙			
	224	230.89	6.06	750	0.51	5790	15400	3.9414	⊙				
	250	257.04	5.45	750	0.46	5790	16500	3.9388	⊙				
	280	289.000	4.844	750	0.41	5790	16470	3.9363	⊙				

**B\*** = B5 & B14

**3c** - Numero delle coppie di riduzione

**B\*** = B5 & B14

**3c** - Number of reduction stages

**B\*** = B5 & B14

**3c** - Anzahl der Getriebestufen

	Olio [ litri ] - Oil [ litres ] - Öl [ Liter ]						Weight [ kg ]
	H1	H2	H3	H4	V1	V2	
FRO43	2.8	2.0	1.6	2.0	2.0	2.5	39.0
FRV43	2.9	1.9	1.2	1.8	2.6	1.7	36.5

**RO5/RV5 - 1800 Nm - 1400 rpm**

	$i_n$	$i_r$	$n_2$ [rpm]	$M_2$ [Nm]	$P_1$ [kW]	$F_{r1}$ [N]	$F_{r2}$ [N]	$J_1 (x 10^{-4})$ [kgm <sup>2</sup> ]	80 90 B5	100 112 B5	132 B*	160 B5	180 B5
<b>FRO53</b>	6.3	6.48	215.9	930	22.4	8200	8020	57.2158	⊙	⊙	⊙	⊙	⊙
<b>FRV53</b>	8.0	8.57	163.3	1100	20.0	8290	8770	52.4172	⊙	⊙	⊙	⊙	⊙
<b>3c</b>	10.0	10.87	128.8	1230	17.6	8350	9470	49.6847	⊙	⊙	⊙	⊙	⊙
	12.5	13.17	106.3	1400	16.6	8350	10050	48.0516	⊙	⊙	⊙	⊙	⊙
	14.0	13.63	102.7	1050	12.0	8110	10340	20.5375	⊙	⊙	⊙	⊙	
	16.0	16.24	86.2	1470	14.1	8360	10150	46.6813	⊙	⊙	⊙	⊙	
	18.0	18.02	77.7	1250	10.8	8260	11300	19.4509	⊙	⊙	⊙		
	20.0	20.53	68.2	1600	12.2	8360	8650	45.5253	⊙	⊙	⊙	⊙	
	22.4	22.85	61.3	1420	9.7	8310	11180	18.8321	⊙	⊙	⊙		
	25.0	26.97	51.9	1670	9.7	8360	8140	44.5592	⊙	⊙	⊙		
	28.0	27.68	50.6	1560	8.8	8350	9800	18.4623	⊙	⊙	⊙		
	31.5	31.69	44.2	1680	8.3	8360	8230	44.1495	⊙	⊙	⊙		
	35.5	34.12	41.0	1690	7.7	8360	8340	18.1520	⊙	⊙	⊙		
	40	41.65	33.6	1700	6.4	8330	8510	14.8941	⊙	⊙	⊙		
	45	43.14	32.5	1700	6.2	8360	8540	17.8902	⊙	⊙	⊙		
	50	51.34	27.3	1720	5.2	8360	8720	14.7570	⊙	⊙			
	56	56.67	24.7	1730	4.8	8360	8820	17.6715	⊙	⊙			
	63	64.91	21.6	1740	4.2	8360	8950	14.6414	⊙	⊙			
	71	72.56	19.3	1660	3.6	8360	10800	17.5356	⊙	⊙			
	80	79.37	17.6	1280	2.5	8360	16160	13.5189	⊙	⊙			
	90	91.04	15.4	1770	3.0	8360	8400	13.4434	⊙	⊙			
	100	100.20	14.0	1780	2.8	8360	8000	14.5038	⊙	⊙			
	112	109.18	12.8	1700	2.4	8360	11200	14.4848	⊙	⊙			
	125	119.59	11.7	1790	2.3	8360	7200	13.3942	⊙	⊙			
	140	140.53	10.0	1790	2.0	8360	7200	13.3734	⊙				
	160	153.12	9.14	1720	1.8	8360	10100	13.3637	⊙				
	180	185.17	7.56	1420	1.2	8360	17640	13.3462	⊙				
	200	208.05	6.73	1330	1.0	8360	19060	13.3560	⊙				
	224	224.24	6.24	1330	0.92	8360	19100	14.4140	⊙				
	250	251.60	5.56	1330	0.82	8360	19100	13.3409	⊙				
	315	314.50	4.45	1330	0.66	8360	19100	13.3277	⊙				

**B\*** = B5 & B14

**3c** - Numero delle coppie di riduzione

**B\*** = B5 & B14

**3c** - Number of reduction stages

**B\*** = B5 & B14

**3c** - Anzahl der Getriebestufen

	Olio [ litri ] - Oil [ litres ] - Öl [ Liter ]						Weight [ kg ]
	H1	H2	H3	H4	V1	V2	
FRO53	5.1	3.6	2.9	3.6	5.0	5.0	73
FRV53	5.2	3.4	2.1	3.2	4.7	4.7	68

**RO6/RV6 - 3400 Nm - 1400 rpm**

	$i_n$	$i_r$	$n_2$ [rpm]	$M_2$ [Nm]	$P_1$ [kW]	$F_{r1}$ [N]	$F_{r2}$ [N]	$J_1 (x 10^{-4})$ [kgm <sup>2</sup> ]	80 90 B5	100 112 B5	132 B*	160 B5	180 B5
<b>FRO63</b>	6.3	6.43	217.7	1660	40.3	6670	10740	102.1187	⊙	⊙	⊙	⊙	⊙
<b>FRV63</b>	8.0	8.50	164.7	1740	31.9	7570	11850	89.9906	⊙	⊙	⊙	⊙	⊙
<b>3c</b>	10.0	10.78	129.9	1970	28.5	7820	12750	81.543	⊙	⊙	⊙	⊙	⊙
	12.5	13.06	107.2	2150	25.7	8010	13550	76.4873	⊙	⊙	⊙	⊙	⊙
	14.0	13.51	103.6	1640	18.9	7530	14110	40.9607	⊙	⊙	⊙	⊙	⊙
	16.0	16.10	87.0	2330	22.6	8190	14450	72.2401	⊙	⊙	⊙	⊙	⊙
	18.0	17.87	78.4	1950	17.0	7880	15380	38.2144	⊙	⊙	⊙	⊙	⊙
	20.0	20.36	68.8	2530	19.4	8310	14100	68.6529	⊙	⊙	⊙	⊙	⊙
	22.4	22.66	61.8	2230	15.4	8090	16460	36.3014	⊙	⊙	⊙	⊙	⊙
	25.0	25.48	55.0	2300	14.1	8230	16820	36.6126	⊙	⊙	⊙	⊙	
	28.0	27.45	51.0	2450	13.9	8240	15700	35.1566	⊙	⊙	⊙	⊙	
	31.5	31.85	44.0	2860	14.0	8360	11540	64.3060	⊙	⊙	⊙	⊙	
	35.5	33.83	41.4	2690	12.4	8310	13920	34.1949	⊙	⊙	⊙	⊙	
	40	42.78	32.7	2950	10.8	8360	11390	33.3825	⊙	⊙	⊙		
	45	42.95	32.6	2540	9.2	8360	16450	62.5533	⊙	⊙	⊙		
	50	50.91	27.5	3360	10.3	8120	9810	25.1536	⊙	⊙	⊙		
	56	56.19	24.9	3360	9.3	8360	9970	32.7029	⊙	⊙	⊙		
	63	64.36	21.8	3360	8.1	8330	10200	24.7949	⊙	⊙	⊙		
	71	73.41	19.1	3250	6.9	8360	11430	32.2564	⊙	⊙	⊙		
	80	84.55	16.6	3360	6.2	8360	11400	24.4947	⊙	⊙	⊙		
	90	90.27	15.5	3360	5.8	8340	11400	21.7196	⊙	⊙	⊙		
	100	100.70	13.9	3360	5.2	8360	9800	24.3601	⊙	⊙			
	112	118.58	11.8	3360	4.4	8360	9800	21.5670	⊙	⊙			
	125	128.72	10.9	2490	3.0	8360	22060	21.6569	⊙	⊙			
	140	141.23	9.9	3360	3.7	8360	9800	21.4986	⊙	⊙			
	160	154.91	9.04	3360	3.4	8360	9800	21.4668	⊙	⊙			
	180	190.49	7.35	2730	2.2	8360	19400	21.4095	⊙	⊙			
	224	220.89	6.34	2550	1.8	8360	22500	21.4455	⊙				
	280	271.62	5.15	2550	1.5	8360	22500	21.3954	⊙				
	315	305.43	4.58	2550	1.3	8360	22500	21.3730	⊙				

**B\*** = B5 & B14

**3c** - Numero delle coppie di riduzione

**B\*** = B5 & B14

**3c** - Number of reduction stages

**B\*** = B5 & B14

**3c** - Anzahl der Getriebestufen

	Olio [ litri ] - Oil [ litres ] - Öl [ Liter ]						Weight [ kg ]
	H1	H2	H3	H4	V1	V2	
FRO63	9.2	6.5	5.2	6.5	9.0	9.0	121
FRV63	9.4	6.1	3.8	5.8	8.5	8.5	117

**MRO/MRV - 1400 rpm**

P <sub>1</sub> [kW]	i <sub>n</sub>	i <sub>r</sub>	n <sub>2</sub> [rpm]	M <sub>2</sub> [Nm]	FS	Tipo - Size - Größe	F <sub>2</sub> [N]	MRO/V [kg]	FRO/V [kg]	J <sub>m</sub> × 10 <sup>-4</sup>	J <sub>1</sub> × 10 <sup>-4</sup>
0.06	7.1	7.58	185	2.9	> 3.5	MRO-MRV 13	3310	9.4	6.9	1.50	0.9150
	9.0	9.14	153	3.5	> 3.5	MRO-MRV 13	3740	9.4	6.9	1.50	0.8480
	10.0	9.57	146	3.7	> 3.5	MRO-MRV 13	3600	9.4	6.9	1.50	0.7740
	11.2	11.63	120	4.5	> 3.5	MRO-MRV 13	3570	9.4	6.9	1.50	0.6940
	14.0	14.02	100	5.2	> 3.5	MRO-MRV 13	4040	9.4	6.9	1.50	0.6660
	16.0	15.14	92.5	5.8	> 3.5	MRO-MRV 13	3550	9.4	6.9	1.50	0.6210
	18.0	18.25	76.7	6.8	> 3.5	MRO-MRV 13	4240	9.4	6.9	1.50	0.6040
	20.0	19.15	73.1	7.3	> 3.5	MRO-MRV 13	3670	9.4	6.9	1.50	0.5770
	22.4	23.33	60	9.3	> 3.5	MRO-MRV 13	3820	9.4	6.9	1.50	0.5510
	25.0	24.44	57.3	9.4	> 3.5	MRO-MRV 13	4150	9.4	6.9	1.50	0.4940
	28.0	29.18	48	11.2	> 3.5	MRO-MRV 13	3960	9.4	6.9	1.50	0.5290
	31.5	31.82	44	12.2	> 3.5	MRO-MRV 13	4120	9.4	6.9	1.50	0.4770
	35.5	37.95	36.9	14.5	> 3.5	MRO-MRV 13	4430	9.4	6.9	1.50	0.5120
	40.0	40.25	34.8	15.4	> 3.5	MRO-MRV 13	4100	9.4	6.9	1.50	0.4670
	45.0	47.88	29.2	18.5	> 3.5	MRO-MRV 13	4300	9.4	6.9	1.50	0.4540
	50.0	49.02	28.6	18.8	> 3.5	MRO-MRV 13	4100	9.4	6.9	1.50	0.4610
	56.0	59.10	23.7	22.7	> 3.5	MRO-MRV 13	4820	9.4	6.9	1.50	0.4600
	63.0	61.31	22.8	23.7	> 3.5	MRO-MRV 13	4000	9.4	6.9	1.50	0.4560
	71.0	73.77	19	28.3	> 3.5	MRO-MRV 13	4000	9.4	6.9	1.50	0.4470
	80.0	84.93	16.5	33.0	> 3.5	MRO-MRV 13	4400	9.4	6.9	1.50	0.4420
	90.0	92.26	15.2	36.0	> 3.5	MRO-MRV 13	4000	9.4	6.9	1.50	0.4450
	100.0	103.46	13.5	40.0	> 3.5	MRO-MRV 13	4000	9.4	6.9	1.50	0.4410
	112.0	111.22	12.6	42.9	3.5	MRO-MRV 13	4800	9.4	6.9	1.50	0.4440
	125.0	129.39	10.8	49.1	> 3.5	MRO-MRV 13	4000	9.4	6.9	1.50	0.4400
	140.0	132.61	10.6	50.0	3.0	MRO-MRV 13	4700	9.4	6.9	1.50	0.4420
	160.0	168.30	8.32	65.6	2.7	MRO-MRV 13	4100	9.4	6.9	1.50	0.4390
	180.0	185.98	7.53	69.2	2.2	MRO-MRV 13	4700	9.4	6.9	1.50	0.4390
	200.0	202.90	6.9	75.0	2.0	MRO-MRV 13	4800	9.4	6.9	1.50	0.4390
	224.0	224.22	6.24	90.0	1.7	MRO-MRV 13	4800	9.4	6.9	1.50	0.4390
	250.0	249.80	5.6	100.0	1.5	MRO-MRV 13	4800	9.4	6.9	1.50	0.4380
315.0	320.51	4.37	130.0	1.0	MRO-MRV 13	4800	9.4	6.9	1.50	0.4380	
0.09	7.1	7.58	185	4.3	> 3.5	MRO-MRV 13	3310	9.5	6.9	2.00	0.9150
	9.0	9.14	153	5.3	> 3.5	MRO-MRV 13	3740	9.5	6.9	2.00	0.8480
	10.0	9.57	146	5.5	> 3.5	MRO-MRV 13	3600	9.5	6.9	2.00	0.7740
	11.2	11.63	120	6.8	> 3.5	MRO-MRV 13	3570	9.5	6.9	2.00	0.6940
	14.0	14.02	100	7.8	> 3.5	MRO-MRV 13	4040	9.5	6.9	2.00	0.6660
	16.0	15.14	92.5	8.7	> 3.5	MRO-MRV 13	3550	9.5	6.9	2.00	0.6210
	18.0	18.25	76.7	10.1	> 3.5	MRO-MRV 13	4240	9.5	6.9	2.00	0.6040
	20.0	19.15	73.1	10.9	> 3.5	MRO-MRV 13	3670	9.5	6.9	2.00	0.5770
	22.4	23.33	60	13.9	> 3.5	MRO-MRV 13	3820	9.5	6.9	2.00	0.5510
	25.0	24.44	57.3	14.1	> 3.5	MRO-MRV 13	4150	9.5	6.9	2.00	0.4940
	28.0	29.18	48	16.8	> 3.5	MRO-MRV 13	3960	9.5	6.9	2.00	0.5290
	31.5	31.82	44	18.3	> 3.5	MRO-MRV 13	4120	9.5	6.9	2.00	0.4770
	35.5	37.95	36.9	21.8	> 3.5	MRO-MRV 13	4430	9.5	6.9	2.00	0.5120
	40.0	40.25	34.8	23.2	> 3.5	MRO-MRV 13	4100	9.5	6.9	2.00	0.4670
	45.0	47.88	29.2	27.8	> 3.5	MRO-MRV 13	4300	9.5	6.9	2.00	0.4540
	50.0	49.02	28.6	28.1	> 3.5	MRO-MRV 13	4100	9.5	6.9	2.00	0.4610
	56.0	59.10	23.7	34.1	> 3.5	MRO-MRV 13	4820	9.5	6.9	2.00	0.4600
	63.0	61.31	22.8	35.6	> 3.5	MRO-MRV 13	4000	9.5	6.9	2.00	0.4560
71.0	73.77	19	42.5	> 3.5	MRO-MRV 13	4000	9.5	6.9	2.00	0.4470	

**MRO/MRV - 1400 rpm**

P <sub>1</sub> [kW]	i <sub>n</sub>	i <sub>r</sub>	n <sub>2</sub> [rpm]	M <sub>2</sub> [Nm]	FS	Tipo - Size - Größe	F <sub>r2</sub> [N]	MRO/V [kg]	FRO/V [kg]	J <sub>m</sub> × 10 <sup>-4</sup>	J <sub>1</sub> × 10 <sup>-4</sup>
0.09	80.0	84.93	16.5	49.5	3.3	MRO-MRV 13	4400	9.5	6.9	2.00	0.4420
	90.0	92.26	15.2	54.0	3.3	MRO-MRV 13	4000	9.5	6.9	2.00	0.4450
	100.0	103.46	13.5	60.0	3.0	MRO-MRV 13	4000	9.5	6.9	2.00	0.4410
	112.0	111.22	12.6	64.3	2.3	MRO-MRV 13	4800	9.5	6.9	2.00	0.4440
	125.0	129.39	10.8	73.6	2.4	MRO-MRV 13	4000	9.5	6.9	2.00	0.4400
	140.0	132.61	10.6	75.0	2.0	MRO-MRV 13	4700	9.5	6.9	2.00	0.4420
	160.0	168.30	8.32	98.4	1.8	MRO-MRV 13	4100	9.5	6.9	2.00	0.4390
	180.0	185.98	7.53	103.8	1.4	MRO-MRV 13	4700	9.5	6.9	2.00	0.4390
	200.0	202.90	6.9	112.5	1.3	MRO-MRV 13	4800	9.5	6.9	2.00	0.4390
	224.0	224.22	6.24	135.0	1.1	MRO-MRV 13	4800	9.5	6.9	2.00	0.4390
	250.0	249.80	5.6	150.0	1.0	MRO-MRV 13	4800	9.5	6.9	2.00	0.4380
315.0	320.51	4.37	195.0	0.7	MRO-MRV 13	4800	9.5	6.9	2.00	0.4380	
0.13	7.1	7.58	185	6.3	> 3.5	MRO-MRV 13	3310	10.6	6.9	2.80	0.9150
	9.0	9.14	153	7.7	> 3.5	MRO-MRV 13	3740	10.6	6.9	2.80	0.8480
	10.0	9.57	146	7.9	> 3.5	MRO-MRV 13	3600	10.6	6.9	2.80	0.7740
	11.2	11.63	120	9.8	> 3.5	MRO-MRV 13	3570	10.6	6.9	2.80	0.6940
	14.0	14.02	100	11.3	> 3.5	MRO-MRV 13	4040	10.6	6.9	2.80	0.6660
	16.0	15.14	92.5	12.6	> 3.5	MRO-MRV 13	3550	10.6	6.9	2.80	0.6210
	18.0	18.25	76.7	14.6	> 3.5	MRO-MRV 13	4240	10.6	6.9	2.80	0.6040
	20.0	19.15	73.1	15.8	> 3.5	MRO-MRV 13	3670	10.6	6.9	2.80	0.5770
	22.4	23.33	60	20.1	> 3.5	MRO-MRV 13	3820	10.6	6.9	2.80	0.5510
	25.0	24.44	57.3	20.3	> 3.5	MRO-MRV 13	4150	10.6	6.9	2.80	0.4940
	28.0	29.18	48	24.3	> 3.5	MRO-MRV 13	3960	10.6	6.9	2.80	0.5290
	31.5	31.82	44	26.5	> 3.5	MRO-MRV 13	4120	10.6	6.9	2.80	0.4770
	35.5	37.95	36.9	31.5	> 3.5	MRO-MRV 13	4430	10.6	6.9	2.80	0.5120
	40.0	40.25	34.8	33.5	> 3.5	MRO-MRV 13	4100	10.6	6.9	2.80	0.4670
	45.0	47.88	29.2	40.2	> 3.5	MRO-MRV 13	4300	10.6	6.9	2.80	0.4540
	50.0	49.02	28.6	40.6	> 3.5	MRO-MRV 13	4100	10.6	6.9	2.80	0.4610
	56.0	59.10	23.7	49.2	2.8	MRO-MRV 13	4820	10.6	6.9	2.80	0.4600
	63.0	61.31	22.8	51.4	3.3	MRO-MRV 13	4000	10.6	6.9	2.80	0.4560
	71.0	73.77	19	61.4	2.8	MRO-MRV 13	4000	10.6	6.9	2.80	0.4470
	80.0	84.93	16.5	71.5	2.3	MRO-MRV 13	4400	10.6	6.9	2.80	0.4420
90.0	92.26	15.2	78.0	2.3	MRO-MRV 13	4000	10.6	6.9	2.80	0.4450	
100.0	103.46	13.5	86.7	2.1	MRO-MRV 13	4000	10.6	6.9	2.80	0.4410	
112.0	111.22	12.6	92.9	1.6	MRO-MRV 13	4800	10.6	6.9	2.80	0.4440	
125.0	129.39	10.8	106.4	1.7	MRO-MRV 13	4000	10.6	6.9	2.80	0.4400	
140.0	132.61	10.6	108.3	1.4	MRO-MRV 13	4700	10.6	6.9	2.80	0.4420	
160.0	168.30	8.32	142.2	1.2	MRO-MRV 13	4100	10.6	6.9	2.80	0.4390	
180.0	185.98	7.53	150.0	1.0	MRO-MRV 13	4700	10.6	6.9	2.80	0.4390	
0.18	7.1	7.58	185	8.7	> 3.5	MRO-MRV 13	3310	11.2	6.9	4.00	0.9150
	9.0	9.14	153	10.6	> 3.5	MRO-MRV 13	3740	11.2	6.9	4.00	0.8480
	10.0	9.57	146	11.0	> 3.5	MRO-MRV 13	3600	11.2	6.9	4.00	0.7740
	11.2	11.63	120	13.5	> 3.5	MRO-MRV 13	3570	11.2	6.9	4.00	0.6940
	14.0	14.02	100	15.6	> 3.5	MRO-MRV 13	4040	11.2	6.9	4.00	0.6660
	16.0	15.14	92.5	17.5	> 3.5	MRO-MRV 13	3550	11.2	6.9	4.00	0.6210
	18.0	18.25	76.7	20.3	> 3.5	MRO-MRV 13	4240	11.2	6.9	4.00	0.6040
	20.0	19.15	73.1	21.9	> 3.5	MRO-MRV 13	3670	11.2	6.9	4.00	0.5770
	22.4	23.33	60	27.8	> 3.5	MRO-MRV 13	3820	11.2	6.9	4.00	0.5510
	25.0	24.44	57.3	28.1	> 3.5	MRO-MRV 13	4150	11.2	6.9	4.00	0.4940
28.0	29.18	48	33.6	> 3.5	MRO-MRV 13	3960	11.2	6.9	4.00	0.5290	

**MRO/MRV - 1400 rpm**

P <sub>1</sub> [kW]	i <sub>n</sub>	i <sub>r</sub>	n <sub>2</sub> [rpm]	M <sub>2</sub> [Nm]	FS	Tipo - Size - Größe	F <sub>r2</sub> [N]	MRO/V [kg]	FRO/V [kg]	J <sub>m</sub> × 10 <sup>-4</sup>	J <sub>1</sub> × 10 <sup>-4</sup>
0.18	31.5	31.82	44	36.7	> 3.5	MRO-MRV 13	4120	11.2	6.9	4.00	0.4770
	35.5	37.95	36.9	43.6	> 3.5	MRO-MRV 13	4430	11.2	6.9	4.00	0.5120
	40.0	40.25	34.8	46.3	> 3.5	MRO-MRV 13	4100	11.2	6.9	4.00	0.4670
	45.0	47.88	29.2	55.6	3.1	MRO-MRV 13	4300	11.2	6.9	4.00	0.4540
	50.0	49.02	28.6	56.3	3.1	MRO-MRV 13	4100	11.2	6.9	4.00	0.4610
	56.0	59.10	23.7	68.1	2.1	MRO-MRV 13	4820	11.2	6.9	4.00	0.4600
	63.0	61.31	22.8	71.2	2.4	MRO-MRV 13	4000	11.2	6.9	4.00	0.4560
	71.0	73.77	19	85.0	2.0	MRO-MRV 13	4000	11.2	6.9	4.00	0.4470
	80.0	84.93	16.5	99.0	1.7	MRO-MRV 13	4400	11.2	6.9	4.00	0.4420
	90.0	92.26	15.2	108.0	1.7	MRO-MRV 13	4000	11.2	6.9	4.00	0.4450
	100.0	103.46	13.5	120.0	1.5	MRO-MRV 13	4000	11.2	6.9	4.00	0.4410
	112.0	111.22	12.6	128.6	1.2	MRO-MRV 13	4800	11.2	6.9	4.00	0.4440
	125.0	129.39	10.8	147.3	1.2	MRO-MRV 13	4000	11.2	6.9	4.00	0.4400
	140.0	132.61	10.6	150.0	1.0	MRO-MRV 13	4700	11.2	6.9	4.00	0.4420
	160.0	168.30	8.32	196.9	0.9	MRO-MRV 13	4100	11.2	6.9	4.00	0.4390
	180.0	185.98	7.53	207.7	0.7	MRO-MRV 13	4700	11.2	6.9	4.00	0.4390
0.25	6.3	6.62	211.4	10.6	> 3.5	MRO-MRV 23	3350	17.1	11.3	5.00	1.7940
	6.43	217.6	10.3	> 3.5	MRO-MRV 33	4550	22.0	16.2	5.00	5.3400	
	6.60	212.1	10.6	> 3.5	MRO-MRV 43	5570	46.8	41.0	5.00	11.5009	
	7.1	7.58	185	12.0	> 3.5	MRO-MRV 13	3310	12.7	6.9	5.00	0.9150
	8.0	8.47	165.3	13.4	> 3.5	MRO-MRV 23	3620	17.1	11.3	5.00	1.3930
	8.25	169.7	13.2	> 3.5	MRO-MRV 33	5540	22.0	16.2	5.00	4.2720	
	8.35	167.6	13.4	> 3.5	MRO-MRV 43	6000	46.8	41.0	5.00	9.2271	
	9.0	9.14	153	14.8	> 3.5	MRO-MRV 13	3740	12.7	6.9	5.00	0.8480
	8.97	156	14.4	> 3.5	MRO-MRV 23	3710	17.1	11.3	5.00	1.5320	
	9.09	154	14.6	> 3.5	MRO-MRV 33	5710	22.0	16.2	5.00	4.6310	
	8.72	160.6	14.0	> 3.5	MRO-MRV 43	5980	46.8	41.0	5.00	10.1119	
	10.0	9.57	146	15.2	> 3.5	MRO-MRV 13	3600	12.7	6.9	5.00	0.7740
	10.43	134.3	16.6	> 3.5	MRO-MRV 23	3870	17.1	11.3	5.00	1.1640	
	10.17	137.7	16.2	> 3.5	MRO-MRV 33	5630	22.0	16.2	5.00	3.6570	
	10.43	134.2	16.8	> 3.5	MRO-MRV 43	6430	46.8	41.0	5.00	7.7706	
	11.2	11.63	120	18.8	> 3.5	MRO-MRV 13	3570	12.7	6.9	5.00	0.6940
	11.48	122	18.5	> 3.5	MRO-MRV 23	4040	17.1	11.3	5.00	1.2320	
	11.65	120.2	18.6	> 3.5	MRO-MRV 33	5730	22.0	16.2	5.00	3.8410	
	11.04	126.8	17.7	> 3.5	MRO-MRV 43	6520	46.8	41.0	5.00	8.3593	
	12.5	13.03	107.4	20.8	> 3.5	MRO-MRV 23	3920	17.1	11.3	5.00	0.9900
	12.72	110	20.5	> 3.5	MRO-MRV 33	5710	22.0	16.2	5.00	3.1860	
	13.29	105.4	21.2	> 3.5	MRO-MRV 43	6950	46.8	41.0	5.00	6.6865	
	14.0	14.02	100	21.7	> 3.5	MRO-MRV 13	4040	12.7	6.9	5.00	0.6660
	14.13	99.1	23.0	> 3.5	MRO-MRV 23	4340	17.1	11.3	5.00	1.0580	
	13.52	103.5	21.7	> 3.5	MRO-MRV 33	5520	22.0	16.2	5.00	2.5250	
	13.87	100.9	22.2	> 3.5	MRO-MRV 43	7190	46.8	41.0	5.00	5.5410	
	16.0	15.14	92.5	24.3	> 3.5	MRO-MRV 13	3550	12.7	6.9	5.00	0.6210
	16.68	83.9	26.3	> 3.5	MRO-MRV 23	3620	17.1	11.3	5.00	0.8580	
16.30	85.9	26.0	> 3.5	MRO-MRV 33	5730	22.0	16.2	5.00	2.8190		
16.21	86.4	26.1	> 3.5	MRO-MRV 43	7420	46.8	41.0	5.00	6.0497		
18.0	18.25	76.7	28.1	> 3.5	MRO-MRV 13	4240	12.7	6.9	5.00	0.6040	
17.80	78.6	28.4	> 3.5	MRO-MRV 23	4480	17.1	11.3	5.00	0.6830		
17.33	80.8	27.7	> 3.5	MRO-MRV 33	5680	22.0	16.2	5.00	2.2830		
17.55	79.8	28.2	> 3.5	MRO-MRV 43	7740	46.8	41.0	5.00	5.0261		

**MRO/MRV - 1400 rpm**

P <sub>1</sub> [kW]	i <sub>n</sub>	i <sub>r</sub>	n <sub>2</sub> [rpm]	M <sub>2</sub> [Nm]	FS	Tipo - Size - Größe	F <sub>r2</sub> [N]	MRO/V [kg]	FRO/V [kg]	J <sub>m</sub> × 10 <sup>-4</sup>	J <sub>1</sub> × 10 <sup>-4</sup>
0.25	20.0	19.15	73.1	30.4	> 3.5	MRO-MRV 13	3670	12.7	6.9	5.00	0.5770
		20.55	68.1	32.3	> 3.5	MRO-MRV 23	3720	17.1	11.3	5.00	0.7790
22.4	22.4	19.10	73.3	30.5	> 3.5	MRO-MRV 33	5730	22.0	16.2	5.00	2.3640
		20.22	69.2	32.5	> 3.5	MRO-MRV 43	7980	46.8	41.0	5.00	5.5318
		23.33	60	38.6	> 3.5	MRO-MRV 13	3820	12.7	6.9	5.00	0.5510
		21.91	63.9	35.5	> 3.5	MRO-MRV 23	4420	17.1	11.3	5.00	0.6310
		21.67	64.6	34.4	> 3.5	MRO-MRV 33	5740	22.0	16.2	5.00	2.5320
25.0	25.0	21.94	63.8	35.2	> 3.5	MRO-MRV 43	8310	46.8	41.0	5.00	4.6963
		24.44	57.3	39.1	> 3.5	MRO-MRV 13	4150	12.7	6.9	5.00	0.4940
		26.07	53.7	40.8	> 3.5	MRO-MRV 23	3930	17.1	11.3	5.00	0.7150
		26.73	52.4	42.4	> 3.5	MRO-MRV 33	5730	22.0	16.2	5.00	2.0370
28.0	28.0	26.10	53.6	42.0	> 3.5	MRO-MRV 43	8690	46.8	41.0	5.00	5.1123
		29.18	48	46.7	> 3.5	MRO-MRV 13	3960	12.7	6.9	5.00	0.5290
		27.39	51.1	43.1	> 3.5	MRO-MRV 23	4180	17.1	11.3	5.00	0.5920
		28.74	48.7	45.5	> 3.5	MRO-MRV 33	5740	22.0	16.2	5.00	1.9940
31.5	31.5	27.92	50.1	44.8	> 3.5	MRO-MRV 43	8990	46.8	41.0	5.00	4.4508
		31.82	44	50.9	3.2	MRO-MRV 13	4120	12.7	6.9	5.00	0.4770
		32.97	42.5	54.2	> 3.5	MRO-MRV 23	4960	17.1	11.3	5.00	0.5440
		33.27	42.1	52.9	> 3.5	MRO-MRV 33	5740	22.0	16.2	5.00	2.2750
35.5	35.5	32.52	43.1	51.7	> 3.5	MRO-MRV 43	9390	46.8	41.0	5.00	4.8644
		37.95	36.9	60.6	2.6	MRO-MRV 13	4430	12.7	6.9	5.00	0.5120
		35.06	39.9	55.4	> 3.5	MRO-MRV 23	4220	17.1	11.3	5.00	0.5620
		34.26	40.9	56.0	> 3.5	MRO-MRV 33	5740	22.0	16.2	5.00	1.9540
40.0	40.0	34.06	41.1	53.8	> 3.5	MRO-MRV 43	9580	46.8	41.0	5.00	4.3066
		40.25	34.8	64.3	2.7	MRO-MRV 13	4100	12.7	6.9	5.00	0.4670
		41.21	34	64.6	> 3.5	MRO-MRV 23	4600	17.1	11.3	5.00	0.5270
45.0	45.0	40.23	34.8	64.8	> 3.5	MRO-MRV 33	5740	22.0	16.2	5.00	1.8490
		47.88	29.2	77.3	2.2	MRO-MRV 13	4300	12.7	6.9	5.00	0.4540
		43.18	32.4	70.5	> 3.5	MRO-MRV 23	4450	17.1	11.3	5.00	0.5440
50.0	50.0	45.54	30.7	71.3	> 3.5	MRO-MRV 33	5740	22.0	16.2	5.00	1.8890
		42.50	32.9	67.7	> 3.5	MRO-MRV 43	10020	46.8	41.0	5.00	4.1893
		49.02	28.6	78.1	2.2	MRO-MRV 13	4100	12.7	6.9	5.00	0.4610
		52.75	26.5	84.2	> 3.5	MRO-MRV 23	4680	17.1	11.3	5.00	0.5130
56.0	56.0	51.55	27.2	80.6	> 3.5	MRO-MRV 33	5740	22.0	16.2	5.00	1.8120
		51.25	27.3	81.7	> 3.5	MRO-MRV 43	9720	46.8	41.0	5.00	4.0217
		59.10	23.7	94.6	1.5	MRO-MRV 13	4820	12.7	6.9	5.00	0.4600
		54.78	25.6	88.1	> 3.5	MRO-MRV 23	4720	17.1	11.3	5.00	0.5290
63.0	63.0	53.60	26.1	85.3	> 3.5	MRO-MRV 33	5740	22.0	16.2	5.00	1.8620
		54.84	25.5	87.5	> 3.5	MRO-MRV 43	9800	46.8	41.0	5.00	4.0943
		61.31	22.8	98.8	1.7	MRO-MRV 13	4000	12.7	6.9	5.00	0.4560
		64.97	21.5	104.7	3.0	MRO-MRV 23	4930	17.1	11.3	5.00	0.5050
71.0	71.0	64.33	21.8	102.5	> 3.5	MRO-MRV 33	5740	22.0	16.2	5.00	1.8750
		63.95	21.9	103.1	> 3.5	MRO-MRV 43	10090	46.8	41.0	5.00	3.9699
		73.77	19	118.1	1.4	MRO-MRV 13	4000	12.7	6.9	5.00	0.4470
		73.98	18.9	118.8	2.4	MRO-MRV 23	5510	17.1	11.3	5.00	0.4950
80.0	80.0	68.52	20.4	111.5	> 3.5	MRO-MRV 33	5740	22.0	16.2	5.00	1.7840
		68.34	20.5	109.5	> 3.5	MRO-MRV 43	10970	46.8	41.0	5.00	4.0382
		84.93	16.5	137.5	1.2	MRO-MRV 13	4400	12.7	6.9	5.00	0.4420
		82.42	17	131.4	2.4	MRO-MRV 23	5100	17.1	11.3	5.00	0.4990
		80.65	17.4	131.8	> 3.5	MRO-MRV 33	5740	22.0	16.2	5.00	1.7720

**MRO/MRV - 1400 rpm**

P <sub>1</sub> [kW]	i <sub>n</sub>	i <sub>r</sub>	n <sub>2</sub> [rpm]	M <sub>2</sub> [Nm]	FS	Tipo - Size - Größe	F <sub>r2</sub> [N]	MRO/V [kg]	FRO/V [kg]	J <sub>m</sub> × 10 <sup>-4</sup>	J <sub>1</sub> × 10 <sup>-4</sup>	
0.25	80.0	82.52	17	131.6	> 3.5	MRO-MRV 43	10510	46.8	41.0	5.00	3.9279	
		90.0	92.26	15.2	150.0	1.2	MRO-MRV 13	4000	12.7	6.9	5.00	0.4450
		91.12	15.4	146.2	2.1	MRO-MRV 23	5100	17.1	11.3	5.00	0.4900	
		91.94	15.2	146.4	2.8	MRO-MRV 33	5740	22.0	16.2	5.00	1.8090	
		89.69	15.6	139.1	> 3.5	MRO-MRV 43	11880	46.8	41.0	5.00	3.8846	
	100.0	103.46	13.5	166.7	1.1	MRO-MRV 13	4000	12.7	6.9	5.00	0.4410	
		106.60	13.1	173.1	1.6	MRO-MRV 23	6000	17.1	11.3	5.00	0.4940	
		105.20	13.3	168.6	3.4	MRO-MRV 33	5750	22.0	16.2	5.00	1.7580	
		102.83	13.6	167.9	> 3.5	MRO-MRV 43	11740	46.8	41.0	5.00	3.9031	
		112.0	115.60	12.1	184.5	1.7	MRO-MRV 23	5100	17.1	11.3	5.00	0.4870
		113.11	12.4	181.3	3.2	MRO-MRV 33	5740	22.0	16.2	5.00	1.7370	
		115.73	12.1	182.1	> 3.5	MRO-MRV 43	11130	46.8	41.0	5.00	3.8632	
		125.0	123.47	11.34	197.0	1.3	MRO-MRV 23	6200	17.1	11.3	5.00	0.4890
		125.46	11.16	200.0	2.4	MRO-MRV 33	5740	22.0	16.2	5.00	1.7510	
		121.80	11.5	195.0	> 3.5	MRO-MRV 43	13730	46.8	41.0	5.00	3.9785	
		140.0	149.51	9.36	241.1	1.1	MRO-MRV 23	6000	17.1	11.3	5.00	0.4850
		147.54	9.49	237.7	2.4	MRO-MRV 33	5740	22.0	16.2	5.00	1.7300	
		144.22	9.71	237.5	> 3.5	MRO-MRV 43	12410	46.8	41.0	5.00	3.8506	
		160.0	156.64	8.94	250.0	1.0	MRO-MRV 23	6200	17.1	11.3	5.00	0.4860
		162.17	8.63	262.2	1.6	MRO-MRV 33	5740	22.0	16.2	5.00	1.7940	
		164.63	8.5	264.1	2.8	MRO-MRV 43	14400	46.8	41.0	5.00	3.8831	
		180.0	170.11	8.23	270.8	1.0	MRO-MRV 23	6200	17.1	11.3	5.00	0.4910
		175.95	7.96	284.9	1.7	MRO-MRV 33	5740	22.0	16.2	5.00	1.7260	
		183.27	7.64	294.8	2.7	MRO-MRV 43	14710	46.8	41.0	5.00	3.8768	
		200.0	202.59	6.91	325.0	0.8	MRO-MRV 23	6200	17.1	11.3	5.00	0.4840
		208.42	6.72	335.9	1.3	MRO-MRV 33	5740	22.0	16.2	5.00	1.7280	
		190.66	7.34	307.4	2.4	MRO-MRV 43	14830	46.8	41.0	5.00	3.8477	
		224.0	238.58	5.87	382.4	0.7	MRO-MRV 23	6200	17.1	11.3	5.00	0.4830
		230.89	6.06	367.6	2.0	MRO-MRV 43	15400	46.8	41.0	5.00	3.8405	
	250.0	248.56	5.63	398.1	1.1	MRO-MRV 33	5740	22.0	16.2	5.00	1.7250	
		257.04	5.45	407.6	1.8	MRO-MRV 43	16500	46.8	41.0	5.00	3.8372	
	280.0	274.11	5.107	430.0	1.0	MRO-MRV 33	5740	22.0	16.2	5.00	1.7240	
289.00		4.844	457.3	1.6	MRO-MRV 43	16470	46.8	41.0	5.00	3.8343		
315.0	342.23	4.091	537.5	0.8	MRO-MRV 33	5740	22.0	16.2	5.00	1.7210		
0.37	6.3	6.62	211.4	15.7	> 3.5	MRO-MRV 23	3350	17.5	11.3	8.00	1.7940	
		6.43	217.6	15.2	> 3.5	MRO-MRV 33	4550	22.4	16.2	8.00	5.3400	
		6.60	212.1	15.7	> 3.5	MRO-MRV 43	5570	47.2	41.0	8.00	11.5009	
	7.1	7.58	185	17.8	> 3.5	MRO-MRV 13	3310	13.1	6.9	8.00	0.9150	
		8.0	8.47	165.3	19.9	> 3.5	MRO-MRV 23	3620	17.5	11.3	8.00	1.3930
		8.25	169.7	19.6	> 3.5	MRO-MRV 33	5540	22.4	16.2	8.00	4.2720	
		8.35	167.6	19.8	> 3.5	MRO-MRV 43	6000	47.2	41.0	8.00	9.2271	
		9.0	9.14	153	21.9	> 3.5	MRO-MRV 13	3740	13.1	6.9	8.00	0.8480
		8.97	156	21.3	> 3.5	MRO-MRV 23	3710	17.5	11.3	8.00	1.5320	
		9.09	154	21.6	> 3.5	MRO-MRV 33	5710	22.4	16.2	8.00	4.6310	
		8.72	160.6	20.7	> 3.5	MRO-MRV 43	5980	47.2	41.0	8.00	10.1119	
		10.0	9.57	146	22.5	> 3.5	MRO-MRV 13	3600	13.1	6.9	8.00	0.7740
		10.43	134.3	24.5	> 3.5	MRO-MRV 23	3870	17.5	11.3	8.00	1.1640	
		10.17	137.7	24.0	> 3.5	MRO-MRV 33	5630	22.4	16.2	8.00	3.6570	
		10.43	134.2	24.8	> 3.5	MRO-MRV 43	6430	47.2	41.0	8.00	7.7706	
	11.2	11.63	120	27.8	> 3.5	MRO-MRV 13	3570	13.1	6.9	8.00	0.6940	



**MRO/MRV - 1400 rpm**

P <sub>1</sub> [kW]	i <sub>n</sub>	i <sub>r</sub>	n <sub>2</sub> [rpm]	M <sub>2</sub> [Nm]	FS	Tipo - Size - Größe	F <sub>r2</sub> [N]	MRO/V [kg]	FRO/V [kg]	J <sub>m</sub> × 10 <sup>-4</sup>	J <sub>1</sub> × 10 <sup>-4</sup>
0.37	11.2	11.48	122	27.5	> 3.5	MRO-MRV 23	4040	17.5	11.3	8.00	1.2320
		11.65	120.2	27.6	> 3.5	MRO-MRV 33	5730	22.4	16.2	8.00	3.8410
12.5	12.5	11.04	126.8	26.1	> 3.5	MRO-MRV 43	6520	47.2	41.0	8.00	8.3593
		13.03	107.4	30.8	> 3.5	MRO-MRV 23	3920	17.5	11.3	8.00	0.9900
		12.72	110	30.3	> 3.5	MRO-MRV 33	5710	22.4	16.2	8.00	3.1860
14.0	14.0	13.29	105.4	31.4	> 3.5	MRO-MRV 43	6950	47.2	41.0	8.00	6.6865
		14.02	100	32.1	> 3.5	MRO-MRV 13	4040	13.1	6.9	8.00	0.6660
		14.13	99.1	34.0	> 3.5	MRO-MRV 23	4340	17.5	11.3	8.00	1.0580
		13.52	103.5	32.1	> 3.5	MRO-MRV 33	5520	22.4	16.2	8.00	2.5250
16.0	16.0	13.87	100.9	32.9	> 3.5	MRO-MRV 43	7190	47.2	41.0	8.00	5.5410
		15.14	92.5	35.9	> 3.5	MRO-MRV 13	3550	13.1	6.9	8.00	0.6210
		16.68	83.9	38.9	> 3.5	MRO-MRV 23	3620	17.5	11.3	8.00	0.8580
		16.30	85.9	38.4	> 3.5	MRO-MRV 33	5730	22.4	16.2	8.00	2.8190
		16.21	86.4	38.6	> 3.5	MRO-MRV 43	7420	47.2	41.0	8.00	6.0497
18.0	18.0	18.25	76.7	41.6	3.2	MRO-MRV 13	4240	13.1	6.9	8.00	0.6040
		17.80	78.6	42.0	> 3.5	MRO-MRV 23	4480	17.5	11.3	8.00	0.6830
		17.33	80.8	41.0	> 3.5	MRO-MRV 33	5680	22.4	16.2	8.00	2.2830
		17.55	79.8	41.8	> 3.5	MRO-MRV 43	7740	47.2	41.0	8.00	5.0261
20.0	20.0	19.15	73.1	44.9	> 3.5	MRO-MRV 13	3670	13.1	6.9	8.00	0.5770
		20.55	68.1	47.8	> 3.5	MRO-MRV 23	3720	17.5	11.3	8.00	0.7790
		19.10	73.3	45.1	> 3.5	MRO-MRV 33	5730	22.4	16.2	8.00	2.3640
		20.22	69.2	48.1	> 3.5	MRO-MRV 43	7980	47.2	41.0	8.00	5.5318
22.4	22.4	23.33	60	57.2	3.0	MRO-MRV 13	3820	13.1	6.9	8.00	0.5510
		21.91	63.9	52.6	> 3.5	MRO-MRV 23	4420	17.5	11.3	8.00	0.6310
		21.67	64.6	50.9	> 3.5	MRO-MRV 33	5740	22.4	16.2	8.00	2.5320
		21.94	63.8	52.1	> 3.5	MRO-MRV 43	8310	47.2	41.0	8.00	4.6963
25.0	25.0	24.44	57.3	57.8	2.6	MRO-MRV 13	4150	13.1	6.9	8.00	0.4940
		26.07	53.7	60.4	> 3.5	MRO-MRV 23	3930	17.5	11.3	8.00	0.7150
		26.73	52.4	62.8	> 3.5	MRO-MRV 33	5730	22.4	16.2	8.00	2.0370
		26.10	53.6	62.2	> 3.5	MRO-MRV 43	8690	47.2	41.0	8.00	5.1123
28.0	28.0	29.18	48	69.1	2.5	MRO-MRV 13	3960	13.1	6.9	8.00	0.5290
		27.39	51.1	63.7	> 3.5	MRO-MRV 23	4180	17.5	11.3	8.00	0.5920
		28.74	48.7	67.3	> 3.5	MRO-MRV 33	5740	22.4	16.2	8.00	1.9940
		27.92	50.1	66.3	> 3.5	MRO-MRV 43	8990	47.2	41.0	8.00	4.4508
31.5	31.5	31.82	44	75.4	2.2	MRO-MRV 13	4120	13.1	6.9	8.00	0.4770
		32.97	42.5	80.2	3.2	MRO-MRV 23	4960	17.5	11.3	8.00	0.5440
		33.27	42.1	78.3	> 3.5	MRO-MRV 33	5740	22.4	16.2	8.00	2.2750
		32.52	43.1	76.6	> 3.5	MRO-MRV 43	9390	47.2	41.0	8.00	4.8644
35.5	35.5	37.95	36.9	89.7	1.8	MRO-MRV 13	4430	13.1	6.9	8.00	0.5120
		35.06	39.9	81.9	> 3.5	MRO-MRV 23	4220	17.5	11.3	8.00	0.5620
		34.26	40.9	82.9	> 3.5	MRO-MRV 33	5740	22.4	16.2	8.00	1.9540
		34.06	41.1	79.7	> 3.5	MRO-MRV 43	9580	47.2	41.0	8.00	4.3066
40.0	40.0	40.25	34.8	95.2	1.8	MRO-MRV 13	4100	13.1	6.9	8.00	0.4670
		41.21	34	95.6	3.2	MRO-MRV 23	4600	17.5	11.3	8.00	0.5270
		40.23	34.8	95.9	> 3.5	MRO-MRV 33	5740	22.4	16.2	8.00	1.8490
45.0	45.0	47.88	29.2	114.4	1.5	MRO-MRV 13	4300	13.1	6.9	8.00	0.4540
		43.18	32.4	104.3	3.0	MRO-MRV 23	4450	17.5	11.3	8.00	0.5440
		45.54	30.7	105.5	> 3.5	MRO-MRV 33	5740	22.4	16.2	8.00	1.8890
		42.50	32.9	100.3	> 3.5	MRO-MRV 43	10020	47.2	41.0	8.00	4.1893
50.0	50.0	49.02	28.6	115.6	1.5	MRO-MRV 13	4100	13.1	6.9	8.00	0.4610

### MRO/MRV - 1400 rpm

P <sub>1</sub> [kW]	i <sub>n</sub>	i <sub>r</sub>	n <sub>2</sub> [rpm]	M <sub>2</sub> [Nm]	FS	Tipo - Size - Größe	F <sub>r2</sub> [N]	MRO/V [kg]	FRO/V [kg]	J <sub>m</sub> × 10 <sup>-4</sup>	J <sub>1</sub> × 10 <sup>-4</sup>
0.37	50.0	52.75	26.5	124.7	2.5	MRO-MRV 23	4680	17.5	11.3	8.00	0.5130
		51.55	27.2	119.2	> 3.5	MRO-MRV 33	5740	22.4	16.2	8.00	1.8120
		51.25	27.3	120.9	> 3.5	MRO-MRV 43	9720	47.2	41.0	8.00	4.0217
56.0	59.10	54.78	23.7	140.0	1.0	MRO-MRV 13	4820	13.1	6.9	8.00	0.4600
		53.60	25.6	130.3	2.4	MRO-MRV 23	4720	17.5	11.3	8.00	0.5290
		54.84	26.1	126.2	> 3.5	MRO-MRV 33	5740	22.4	16.2	8.00	1.8620
63.0	61.31	54.84	25.5	129.5	> 3.5	MRO-MRV 43	9800	47.2	41.0	8.00	4.0943
		64.97	22.8	146.3	1.2	MRO-MRV 13	4000	13.1	6.9	8.00	0.4560
		64.33	21.5	155.0	2.0	MRO-MRV 23	4930	17.5	11.3	8.00	0.5050
71.0	73.77	63.95	21.8	151.7	2.7	MRO-MRV 33	5740	22.4	16.2	8.00	1.8750
		63.95	21.9	152.6	> 3.5	MRO-MRV 43	10090	47.2	41.0	8.00	3.9699
		73.98	19	174.7	1.0	MRO-MRV 13	4000	13.1	6.9	8.00	0.4470
80.0	84.93	68.52	18.9	175.8	1.6	MRO-MRV 23	5510	17.5	11.3	8.00	0.4950
		68.52	20.4	165.1	> 3.5	MRO-MRV 33	5740	22.4	16.2	8.00	1.7840
		68.34	20.5	162.1	> 3.5	MRO-MRV 43	10970	47.2	41.0	8.00	4.0382
90.0	92.26	80.65	16.5	203.5	0.8	MRO-MRV 13	4400	13.1	6.9	8.00	0.4420
		82.52	17	194.4	1.6	MRO-MRV 23	5100	17.5	11.3	8.00	0.4990
		82.52	17	194.7	> 3.5	MRO-MRV 43	10510	47.2	41.0	8.00	3.9279
100.0	103.46	89.69	15.2	222.0	0.8	MRO-MRV 13	4000	13.1	6.9	8.00	0.4450
		106.60	15.4	216.4	1.4	MRO-MRV 23	5100	17.5	11.3	8.00	0.4900
		106.60	15.2	216.7	1.9	MRO-MRV 33	5740	22.4	16.2	8.00	1.8090
112.0	115.60	102.83	15.6	205.8	> 3.5	MRO-MRV 43	11880	47.2	41.0	8.00	3.8846
		102.83	13.5	246.7	0.7	MRO-MRV 13	4000	13.1	6.9	8.00	0.4410
		102.83	13.1	256.2	1.1	MRO-MRV 23	6000	17.5	11.3	8.00	0.4940
125.0	123.47	105.20	13.3	249.5	2.3	MRO-MRV 33	5750	22.4	16.2	8.00	1.7580
		105.20	13.6	248.4	> 3.5	MRO-MRV 43	11740	47.2	41.0	8.00	3.9031
		115.73	12.1	273.1	1.1	MRO-MRV 23	5100	17.5	11.3	8.00	0.4870
140.0	149.51	113.11	12.4	268.3	2.2	MRO-MRV 33	5740	22.4	16.2	8.00	1.7370
		113.11	12.1	269.6	> 3.5	MRO-MRV 43	11130	47.2	41.0	8.00	3.8632
		125.46	11.34	291.5	0.9	MRO-MRV 23	6200	17.5	11.3	8.00	0.4890
160.0	162.17	125.46	11.16	296.0	1.6	MRO-MRV 33	5740	22.4	16.2	8.00	1.7510
		125.46	11.5	288.6	2.7	MRO-MRV 43	13730	47.2	41.0	8.00	3.9785
		144.22	9.36	356.8	0.8	MRO-MRV 23	6000	17.5	11.3	8.00	0.4850
180.0	183.27	147.54	9.49	351.8	1.6	MRO-MRV 33	5740	22.4	16.2	8.00	1.7300
		147.54	9.71	351.5	2.7	MRO-MRV 43	12410	47.2	41.0	8.00	3.8506
		156.64	8.94	370.0	0.7	MRO-MRV 23	6200	17.5	11.3	8.00	0.4860
200.0	208.42	162.17	8.63	388.0	1.1	MRO-MRV 33	5740	22.4	16.2	8.00	1.7940
		162.17	8.5	390.8	1.9	MRO-MRV 43	14400	47.2	41.0	8.00	3.8831
		164.63	7.96	421.6	1.2	MRO-MRV 33	5740	22.4	16.2	8.00	1.7260
224.0	230.89	183.27	7.64	436.3	1.8	MRO-MRV 43	14710	47.2	41.0	8.00	3.8768
		183.27	6.72	497.2	0.9	MRO-MRV 33	5740	22.4	16.2	8.00	1.7280
		190.66	7.34	454.9	1.6	MRO-MRV 43	14830	47.2	41.0	8.00	3.8477
250.0	257.04	190.66	6.06	544.1	1.4	MRO-MRV 43	15400	47.2	41.0	8.00	3.8405
		248.56	5.63	589.3	0.7	MRO-MRV 33	5740	22.4	16.2	8.00	1.7250
		248.56	5.45	603.3	1.2	MRO-MRV 43	16500	47.2	41.0	8.00	3.8372
280.0	289.00	257.04	4.844	676.8	1.1	MRO-MRV 43	16470	47.2	41.0	8.00	3.8343
		289.00	23.4	23.4	> 3.5	MRO-MRV 23	3350	19.8	11.3	14.00	1.7940
		289.00	22.6	22.6	> 3.5	MRO-MRV 33	4550	24.7	16.2	14.00	5.3400
0.55	6.3	6.43	217.6	22.6	> 3.5	MRO-MRV 33	4550	24.7	16.2	14.00	5.3400
		6.43	212.1	23.3	> 3.5	MRO-MRV 43	5570	49.5	41.0	14.00	11.5009
		6.60	212.1	23.3	> 3.5	MRO-MRV 43	5570	49.5	41.0	14.00	11.5009

**MRO/MRV - 1400 rpm**

P <sub>1</sub> [kW]	i <sub>n</sub>	i <sub>r</sub>	n <sub>2</sub> [rpm]	M <sub>2</sub> [Nm]	FS	Tipo - Size - Größe	F <sub>r2</sub> [N]	MRO/V [kg]	FRO/V [kg]	J <sub>m</sub> × 10 <sup>-4</sup>	J <sub>1</sub> × 10 <sup>-4</sup>
0.55	6.3	6.48	215.9	22.8	> 3.5	MRO-MRV 53	8020	85.1	76.6	14.00	46.0154
		6.43	217.7	22.7	> 3.5	MRO-MRV 63	10740	136.0	127.5	14.00	78.1860
	7.1	7.58	185	26.5	> 3.5	MRO-MRV 13	3310	15.4	6.9	14.00	0.9150
		8.0	165.3	29.5	> 3.5	MRO-MRV 23	3620	19.8	11.3	14.00	1.3930
	8.0	8.47	165.3	29.5	> 3.5	MRO-MRV 23	3620	19.8	11.3	14.00	1.3930
		8.25	169.7	29.1	> 3.5	MRO-MRV 33	5540	24.7	16.2	14.00	4.2720
	8.0	8.35	167.6	29.4	> 3.5	MRO-MRV 43	6000	49.5	41.0	14.00	9.2271
		8.57	163.3	30.3	> 3.5	MRO-MRV 53	8770	85.1	76.6	14.00	38.9230
	9.0	8.50	164.7	30.0	> 3.5	MRO-MRV 63	11850	136.0	127.5	14.00	60.6320
		9.14	153	32.5	> 3.5	MRO-MRV 13	3740	15.4	6.9	14.00	0.8480
	9.0	8.97	156	31.7	> 3.5	MRO-MRV 23	3710	19.8	11.3	14.00	1.5320
		9.09	154	32.2	> 3.5	MRO-MRV 33	5710	24.7	16.2	14.00	4.6310
	10.0	8.72	160.6	30.8	> 3.5	MRO-MRV 43	5980	49.5	41.0	14.00	10.1119
		9.57	146	33.5	> 3.5	MRO-MRV 13	3600	15.4	6.9	14.00	0.7740
	10.0	10.43	134.3	36.4	> 3.5	MRO-MRV 23	3870	19.8	11.3	14.00	1.1640
		10.17	137.7	35.7	> 3.5	MRO-MRV 33	5630	24.7	16.2	14.00	3.6570
	10.0	10.43	134.2	36.9	> 3.5	MRO-MRV 43	6430	49.5	41.0	14.00	7.7706
		10.87	128.8	38.4	> 3.5	MRO-MRV 53	9470	85.1	76.6	14.00	34.9392
	11.2	10.78	129.9	38.0	> 3.5	MRO-MRV 63	12750	136.0	127.5	14.00	48.5070
		11.63	120	41.3	> 3.5	MRO-MRV 13	3570	15.4	6.9	14.00	0.6940
	11.2	11.48	122	40.8	> 3.5	MRO-MRV 23	4040	19.8	11.3	14.00	1.2320
		11.65	120.2	41.0	> 3.5	MRO-MRV 33	5730	24.7	16.2	14.00	3.8410
	12.5	11.04	126.8	38.9	> 3.5	MRO-MRV 43	6520	49.5	41.0	14.00	8.3593
		13.03	107.4	45.8	> 3.5	MRO-MRV 23	3920	19.8	11.3	14.00	0.9900
	12.5	12.72	110	45.0	> 3.5	MRO-MRV 33	5710	24.7	16.2	14.00	3.1860
		13.29	105.4	46.6	> 3.5	MRO-MRV 43	6950	49.5	41.0	14.00	6.6865
	14.0	13.17	106.3	46.4	> 3.5	MRO-MRV 53	10050	85.1	76.6	14.00	32.6124
		13.06	107.2	46.0	> 3.5	MRO-MRV 63	13550	136.0	127.5	14.00	41.5040
	14.0	14.02	100	47.7	2.7	MRO-MRV 13	4040	15.4	6.9	14.00	0.6660
		14.13	99.1	50.6	> 3.5	MRO-MRV 23	4340	19.8	11.3	14.00	1.0580
	14.0	13.52	103.5	47.7	> 3.5	MRO-MRV 33	5520	24.7	16.2	14.00	2.5250
		13.87	100.9	48.8	> 3.5	MRO-MRV 43	7190	49.5	41.0	14.00	5.5410
	16.0	13.63	102.7	48.1	> 3.5	MRO-MRV 53	10340	85.1	76.6	14.00	29.4533
		13.51	103.6	47.7	> 3.5	MRO-MRV 63	14110	136.0	127.5	14.00	30.9420
	16.0	15.14	92.5	53.4	3.1	MRO-MRV 13	3550	15.4	6.9	14.00	0.6210
		16.68	83.9	57.8	> 3.5	MRO-MRV 23	3620	19.8	11.3	14.00	0.8580
	16.0	16.30	85.9	57.1	> 3.5	MRO-MRV 33	5730	24.7	16.2	14.00	2.8190
		16.21	86.4	57.4	> 3.5	MRO-MRV 43	7420	49.5	41.0	14.00	6.0497
	16.0	16.24	86.2	57.3	> 3.5	MRO-MRV 53	10150	85.1	76.6	14.00	30.7169
		16.10	87	56.7	> 3.5	MRO-MRV 63	14450	136.0	127.5	14.00	35.7680
	18.0	18.25	76.7	61.9	2.2	MRO-MRV 13	4240	15.4	6.9	14.00	0.6040
		17.80	78.6	62.5	> 3.5	MRO-MRV 23	4480	19.8	11.3	14.00	0.6830
	18.0	17.33	80.8	61.0	> 3.5	MRO-MRV 33	5680	24.7	16.2	14.00	2.2830
		17.55	79.8	62.1	> 3.5	MRO-MRV 43	7740	49.5	41.0	14.00	5.0261
	18.0	18.02	77.7	63.7	> 3.5	MRO-MRV 53	11300	85.1	76.6	14.00	27.8473
		17.87	78.4	63.1	> 3.5	MRO-MRV 63	15380	136.0	127.5	14.00	26.9670
	20.0	19.15	73.1	66.8	2.5	MRO-MRV 13	3670	15.4	6.9	14.00	0.5770
		20.55	68.1	71.0	> 3.5	MRO-MRV 23	3720	19.8	11.3	14.00	0.7790
	20.0	19.10	73.3	67.0	> 3.5	MRO-MRV 33	5730	24.7	16.2	14.00	2.3640
		20.22	69.2	71.5	> 3.5	MRO-MRV 43	7980	49.5	41.0	14.00	5.5318
		20.53	68.2	72.1	> 3.5	MRO-MRV 53	8650	85.1	76.6	14.00	29.1621

**MRO/MRV - 1400 rpm**

P <sub>1</sub> [kW]	i <sub>n</sub>	i <sub>r</sub>	n <sub>2</sub> [rpm]	M <sub>2</sub> [Nm]	FS	Tipo - Size - Größe	F <sub>r2</sub> [N]	MRO/V [kg]	FRO/V [kg]	J <sub>m</sub> × 10 <sup>-4</sup>	J <sub>1</sub> × 10 <sup>-4</sup>
0.55	20.0	20.36	68.8	71.7	> 3.5	MRO-MRV 63	14100	136.0	127.5	14.00	31.0610
	22.4	23.33	60	85.0	2.0	MRO-MRV 13	3820	15.4	6.9	14.00	0.5510
		21.91	63.9	78.2	3.5	MRO-MRV 23	4420	19.8	11.3	14.00	0.6310
		21.67	64.6	75.6	> 3.5	MRO-MRV 33	5740	24.7	16.2	14.00	2.5320
		21.94	63.8	77.4	> 3.5	MRO-MRV 43	8310	49.5	41.0	14.00	4.6963
		22.85	61.3	80.5	> 3.5	MRO-MRV 53	11180	85.1	76.6	14.00	26.9452
		22.66	61.8	79.6	> 3.5	MRO-MRV 63	16460	136.0	127.5	14.00	24.2220
	25.0	24.44	57.3	85.9	1.7	MRO-MRV 13	4150	15.4	6.9	14.00	0.4940
		26.07	53.7	89.7	3.5	MRO-MRV 23	3930	19.8	11.3	14.00	0.7150
		26.73	52.4	93.3	> 3.5	MRO-MRV 33	5730	24.7	16.2	14.00	2.0370
		26.10	53.6	92.4	> 3.5	MRO-MRV 43	8690	49.5	41.0	14.00	5.1123
		26.97	51.9	94.7	> 3.5	MRO-MRV 53	8140	85.1	76.6	14.00	27.9078
		25.48	55	89.7	> 3.5	MRO-MRV 63	16820	136.0	127.5	14.00	25.3770
	28.0	29.18	48	102.7	1.7	MRO-MRV 13	3960	15.4	6.9	14.00	0.5290
		27.39	51.1	94.7	3.3	MRO-MRV 23	4180	19.8	11.3	14.00	0.5920
		28.74	48.7	100.0	> 3.5	MRO-MRV 33	5740	24.7	16.2	14.00	1.9940
		27.92	50.1	98.5	> 3.5	MRO-MRV 43	8990	49.5	41.0	14.00	4.4508
		27.68	50.6	97.5	> 3.5	MRO-MRV 53	9800	85.1	76.6	14.00	26.4183
		27.45	51	96.9	> 3.5	MRO-MRV 63	15700	136.0	127.5	14.00	22.6360
	31.5	31.82	44	112.0	1.5	MRO-MRV 13	4120	15.4	6.9	14.00	0.4770
		32.97	42.5	119.2	2.2	MRO-MRV 23	4960	19.8	11.3	14.00	0.5440
		33.27	42.1	116.3	> 3.5	MRO-MRV 33	5740	24.7	16.2	14.00	2.2750
		32.52	43.1	113.8	> 3.5	MRO-MRV 43	9390	49.5	41.0	14.00	4.8644
		31.69	44.2	111.3	> 3.5	MRO-MRV 53	8230	85.1	76.6	14.00	27.3913
		31.85	44	112.4	> 3.5	MRO-MRV 63	11540	136.0	127.5	14.00	25.5240
	35.5	37.95	36.9	133.3	1.2	MRO-MRV 13	4430	15.4	6.9	14.00	0.5120
		35.06	39.9	121.8	2.5	MRO-MRV 23	4220	19.8	11.3	14.00	0.5620
		34.26	40.9	123.2	> 3.5	MRO-MRV 33	5740	24.7	16.2	14.00	1.9540
		34.06	41.1	118.5	> 3.5	MRO-MRV 43	9580	49.5	41.0	14.00	4.3066
		34.12	41	120.7	> 3.5	MRO-MRV 53	8340	85.1	76.6	14.00	25.9891
		33.83	41.4	119.3	> 3.5	MRO-MRV 63	13920	136.0	127.5	14.00	21.3370
	40.0	40.25	34.8	141.5	1.2	MRO-MRV 13	4100	15.4	6.9	14.00	0.4670
		41.21	34	142.1	2.2	MRO-MRV 23	4600	19.8	11.3	14.00	0.5270
		40.23	34.8	142.5	> 3.5	MRO-MRV 33	5740	24.7	16.2	14.00	1.8490
		41.65	33.6	146.1	> 3.5	MRO-MRV 53	8510	85.1	76.6	14.00	25.4059
		42.78	32.7	150.2	> 3.5	MRO-MRV 63	11390	136.0	127.5	14.00	20.2710
	45.0	47.88	29.2	170.0	1.0	MRO-MRV 13	4300	15.4	6.9	14.00	0.4540
		43.18	32.4	155.0	2.0	MRO-MRV 23	4450	19.8	11.3	14.00	0.5440
		45.54	30.7	156.8	> 3.5	MRO-MRV 33	5740	24.7	16.2	14.00	1.8890
		42.50	32.9	149.0	> 3.5	MRO-MRV 43	10020	49.5	41.0	14.00	4.1893
		43.14	32.5	150.8	> 3.5	MRO-MRV 53	8540	85.1	76.6	14.00	25.6370
		42.95	32.6	151.8	> 3.5	MRO-MRV 63	16450	136.0	127.5	14.00	23.3660
	50.0	49.02	28.6	171.9	1.0	MRO-MRV 13	4100	15.4	6.9	14.00	0.4610
		52.75	26.5	185.3	1.7	MRO-MRV 23	4680	19.8	11.3	14.00	0.5130
		51.55	27.2	177.2	3.3	MRO-MRV 33	5740	24.7	16.2	14.00	1.8120
		51.25	27.3	179.7	> 3.5	MRO-MRV 43	9720	49.5	41.0	14.00	4.0217
		51.34	27.3	181.9	> 3.5	MRO-MRV 53	8720	85.1	76.6	14.00	25.2163
		50.91	27.5	179.4	> 3.5	MRO-MRV 63	9810	136.0	127.5	14.00	18.9780
	56.0	54.78	25.6	193.8	1.6	MRO-MRV 23	4720	19.8	11.3	14.00	0.5290
		53.60	26.1	187.6	3.1	MRO-MRV 33	5740	24.7	16.2	14.00	1.8620

**MRO/MRV - 1400 rpm**

P <sub>1</sub> [kW]	i <sub>n</sub>	i <sub>r</sub>	n <sub>2</sub> [rpm]	M <sub>2</sub> [Nm]	FS	Tipo - Size - Größe	F <sub>r2</sub> [N]	MRO/V [kg]	FRO/V [kg]	J <sub>m</sub> × 10 <sup>-4</sup>	J <sub>1</sub> × 10 <sup>-4</sup>
0.55	56.0	54.84	25.5	192.5	> 3.5	MRO-MRV 43	9800	49.5	41.0	14.00	4.0943
		56.67	24.7	198.2	> 3.5	MRO-MRV 53	8820	85.1	76.6	14.00	25.3529
63.0	63.0	56.19	24.9	198.7	> 3.5	MRO-MRV 63	9970	136.0	127.5	14.00	19.4030
		64.97	21.5	230.4	1.3	MRO-MRV 23	4930	19.8	11.3	14.00	0.5050
		64.33	21.8	225.5	1.8	MRO-MRV 33	5740	24.7	16.2	14.00	1.8750
71.0	71.0	63.95	21.9	226.9	> 3.5	MRO-MRV 43	10090	49.5	41.0	14.00	3.9699
		64.91	21.6	227.9	> 3.5	MRO-MRV 53	8950	85.1	76.6	14.00	25.0608
		64.36	21.8	228.1	> 3.5	MRO-MRV 63	10200	136.0	127.5	14.00	18.5080
		73.98	18.9	261.3	1.1	MRO-MRV 23	5510	19.8	11.3	14.00	0.4950
80.0	80.0	68.52	20.4	245.4	2.4	MRO-MRV 33	5740	24.7	16.2	14.00	1.7840
		68.34	20.5	241.0	> 3.5	MRO-MRV 43	10970	49.5	41.0	14.00	4.0382
		72.56	19.3	253.6	> 3.5	MRO-MRV 53	10800	85.1	76.6	14.00	25.1812
		73.41	19.1	259.1	> 3.5	MRO-MRV 63	11430	136.0	127.5	14.00	18.8420
		82.42	17	289.0	1.1	MRO-MRV 23	5100	19.8	11.3	14.00	0.4990
90.0	90.0	80.65	17.4	290.0	2.0	MRO-MRV 33	5740	24.7	16.2	14.00	1.7720
		82.52	17	289.5	3.5	MRO-MRV 43	10510	49.5	41.0	14.00	3.9279
		79.37	17.6	281.6	> 3.5	MRO-MRV 53	16160	85.1	76.6	14.00	25.0122
		84.55	16.6	298.1	> 3.5	MRO-MRV 63	11400	136.0	127.5	14.00	18.1240
100.0	100.0	91.94	15.2	322.1	1.3	MRO-MRV 33	5740	24.7	16.2	14.00	1.8090
		89.69	15.6	305.9	2.9	MRO-MRV 43	11880	49.5	41.0	14.00	3.8846
		91.04	15.4	324.5	> 3.5	MRO-MRV 53	8400	85.1	76.6	14.00	24.8176
		90.27	15.5	318.6	> 3.5	MRO-MRV 63	11400	136.0	127.5	14.00	17.8220
112.0	112.0	105.20	13.3	370.9	1.6	MRO-MRV 33	5750	24.7	16.2	14.00	1.7580
		102.83	13.6	369.3	2.5	MRO-MRV 43	11740	49.5	41.0	14.00	3.9031
		100.20	14	349.6	> 3.5	MRO-MRV 53	8000	85.1	76.6	14.00	24.8837
		100.70	13.9	355.4	> 3.5	MRO-MRV 63	9800	136.0	127.5	14.00	17.9540
125.0	125.0	113.11	12.4	398.8	1.5	MRO-MRV 33	5740	24.7	16.2	14.00	1.7370
		115.73	12.1	400.7	2.5	MRO-MRV 43	11130	49.5	41.0	14.00	3.8632
		109.18	12.8	389.6	> 3.5	MRO-MRV 53	11200	85.1	76.6	14.00	24.8595
		118.58	11.8	420.0	> 3.5	MRO-MRV 63	9800	136.0	127.5	14.00	17.6270
140.0	140.0	125.46	11.16	440.0	1.1	MRO-MRV 33	5740	24.7	16.2	14.00	1.7510
		121.80	11.5	429.0	1.8	MRO-MRV 43	13730	49.5	41.0	14.00	3.9785
		119.59	11.7	428.0	> 3.5	MRO-MRV 53	7200	85.1	76.6	14.00	24.7730
		128.72	10.9	456.5	> 3.5	MRO-MRV 63	22060	136.0	127.5	14.00	17.7600
160.0	160.0	147.54	9.49	523.0	1.1	MRO-MRV 33	5740	24.7	16.2	14.00	1.7300
		144.22	9.71	522.5	1.8	MRO-MRV 43	12410	49.5	41.0	14.00	3.8506
		140.53	10	492.3	> 3.5	MRO-MRV 53	7200	85.1	76.6	14.00	24.7467
		141.23	9.9	499.5	> 3.5	MRO-MRV 63	9800	136.0	127.5	14.00	17.5400
180.0	180.0	164.63	8.5	581.0	1.3	MRO-MRV 43	14400	49.5	41.0	14.00	3.8831
		153.12	9.14	525.6	3.3	MRO-MRV 53	10100	85.1	76.6	14.00	24.7344
		154.91	9.04	543.5	> 3.5	MRO-MRV 63	9800	136.0	127.5	14.00	17.5010
200.0	200.0	183.27	7.64	648.5	1.2	MRO-MRV 43	14710	49.5	41.0	14.00	3.8768
		185.17	7.56	650.8	2.2	MRO-MRV 53	17640	85.1	76.6	14.00	24.7124
		190.49	7.35	682.5	> 3.5	MRO-MRV 63	19400	136.0	127.5	14.00	17.4310
224.0	224.0	190.66	7.34	676.2	1.1	MRO-MRV 43	14830	49.5	41.0	14.00	3.8477
		208.05	6.73	731.5	1.8	MRO-MRV 53	19060	85.1	76.6	14.00	24.7277
250.0	250.0	224.24	6.24	795.1	1.7	MRO-MRV 53	19100	85.1	76.6	14.00	24.7733
		220.89	6.34	779.2	3.3	MRO-MRV 63	22500	136.0	127.5	14.00	17.4800
280.0	280.0	251.60	5.56	892.1	1.5	MRO-MRV 53	19100	85.1	76.6	14.00	24.7078
		271.62	5.15	935.0	2.7	MRO-MRV 63	22500	136.0	127.5	14.00	17.4170

### MRO/MRV - 1400 rpm

P <sub>1</sub> [kW]	i <sub>n</sub>	i <sub>r</sub>	n <sub>2</sub> [rpm]	M <sub>2</sub> [Nm]	FS	Tipo - Size - Größe	F <sub>r2</sub> [N]	MRO/V [kg]	FRO/V [kg]	J <sub>m</sub> × 10 <sup>-4</sup>	J <sub>1</sub> × 10 <sup>-4</sup>	
0.55	315.0	314.50	4.45	1108.3	1.2	MRO-MRV 53	19100	85.1	76.6	14.00	24.6906	
		305.43	4.58	1078.8	2.4	MRO-MRV 63	22500	136.0	127.5	14.00	17.3880	
0.75	6.3	6.62	211.4	31.9	> 3.5	MRO-MRV 23	3350	21.1	11.3	17.00	1.7940	
		6.43	217.6	30.9	> 3.5	MRO-MRV 33	4550	26.0	16.2	17.00	5.3400	
		6.60	212.1	31.8	> 3.5	MRO-MRV 43	5570	50.8	41.0	17.00	11.5009	
		6.48	215.9	31.1	> 3.5	MRO-MRV 53	8020	86.4	76.6	17.00	46.0154	
		6.43	217.7	30.9	> 3.5	MRO-MRV 63	10740	137.3	127.5	17.00	78.1860	
	7.1	7.58	185	36.1	> 3.5	MRO-MRV 13	3310	16.7	6.9	17.00	0.9150	
		8.0	8.47	165.3	40.2	> 3.5	MRO-MRV 23	3620	21.1	11.3	17.00	1.3930
			8.25	169.7	39.7	> 3.5	MRO-MRV 33	5540	26.0	16.2	17.00	4.2720
			8.35	167.6	40.2	> 3.5	MRO-MRV 43	6000	50.8	41.0	17.00	9.2271
	8.57		163.3	41.3	> 3.5	MRO-MRV 53	8770	86.4	76.6	17.00	38.9230	
	8.50	8.50	164.7	40.9	> 3.5	MRO-MRV 63	11850	137.3	127.5	17.00	60.6320	
		9.0	9.14	153	44.3	2.9	MRO-MRV 13	3740	16.7	6.9	17.00	0.8480
			8.97	156	43.3	> 3.5	MRO-MRV 23	3710	21.1	11.3	17.00	1.5320
			9.09	154	43.8	> 3.5	MRO-MRV 33	5710	26.0	16.2	17.00	4.6310
	8.72	160.6	42.0	> 3.5	MRO-MRV 43	5980	50.8	41.0	17.00	10.1119		
		10.0	9.57	146	45.7	3.1	MRO-MRV 13	3600	16.7	6.9	17.00	0.7740
			10.43	134.3	49.7	> 3.5	MRO-MRV 23	3870	21.1	11.3	17.00	1.1640
			10.17	137.7	48.7	> 3.5	MRO-MRV 33	5630	26.0	16.2	17.00	3.6570
	10.43		134.2	50.3	> 3.5	MRO-MRV 43	6430	50.8	41.0	17.00	7.7706	
	10.87	128.8	52.4	> 3.5	MRO-MRV 53	9470	86.4	76.6	17.00	34.9392		
		10.78	129.9	51.8	> 3.5	MRO-MRV 63	12750	137.3	127.5	17.00	48.5070	
		11.2	11.63	120	56.3	2.7	MRO-MRV 13	3570	16.7	6.9	17.00	0.6940
			11.48	122	55.6	> 3.5	MRO-MRV 23	4040	21.1	11.3	17.00	1.2320
	11.65		120.2	55.9	> 3.5	MRO-MRV 33	5730	26.0	16.2	17.00	3.8410	
	11.04	126.8	53.0	> 3.5	MRO-MRV 43	6520	50.8	41.0	17.00	8.3593		
		12.5	13.03	107.4	62.5	> 3.5	MRO-MRV 23	3920	21.1	11.3	17.00	0.9900
			12.72	110	61.4	> 3.5	MRO-MRV 33	5710	26.0	16.2	17.00	3.1860
			13.29	105.4	63.6	> 3.5	MRO-MRV 43	6950	50.8	41.0	17.00	6.6865
	13.17	106.3	63.3	> 3.5	MRO-MRV 53	10050	86.4	76.6	17.00	32.6124		
		13.06	107.2	62.7	> 3.5	MRO-MRV 63	13550	137.3	127.5	17.00	41.5040	
		14.0	14.02	100	65.0	2.0	MRO-MRV 13	4040	16.7	6.9	17.00	0.6660
			14.13	99.1	69.0	3.3	MRO-MRV 23	4340	21.1	11.3	17.00	1.0580
13.52	103.5		65.1	> 3.5	MRO-MRV 33	5520	26.0	16.2	17.00	2.5250		
13.87	100.9		66.6	> 3.5	MRO-MRV 43	7190	50.8	41.0	17.00	5.5410		
13.63	102.7	65.6	> 3.5	MRO-MRV 53	10340	86.4	76.6	17.00	29.4533			
	13.51	103.6	65.1	> 3.5	MRO-MRV 63	14110	137.3	127.5	17.00	30.9420		
	16.0	15.14	92.5	72.8	2.3	MRO-MRV 13	3550	16.7	6.9	17.00	0.6210	
		16.68	83.9	78.9	> 3.5	MRO-MRV 23	3620	21.1	11.3	17.00	0.8580	
16.30		85.9	77.9	> 3.5	MRO-MRV 33	5730	26.0	16.2	17.00	2.8190		
16.21		86.4	78.2	> 3.5	MRO-MRV 43	7420	50.8	41.0	17.00	6.0497		
16.24	86.2	78.2	> 3.5	MRO-MRV 53	10150	86.4	76.6	17.00	30.7169			
	16.10	87	77.3	> 3.5	MRO-MRV 63	14450	137.3	127.5	17.00	35.7680		
	18.0	18.25	76.7	84.4	1.6	MRO-MRV 13	4240	16.7	6.9	17.00	0.6040	
		17.80	78.6	85.2	2.9	MRO-MRV 23	4480	21.1	11.3	17.00	0.6830	
17.33		80.8	83.2	> 3.5	MRO-MRV 33	5680	26.0	16.2	17.00	2.2830		
17.55		79.8	84.7	> 3.5	MRO-MRV 43	7740	50.8	41.0	17.00	5.0261		
18.02	77.7	86.8	> 3.5	MRO-MRV 53	11300	86.4	76.6	17.00	27.8473			
	17.87	78.4	86.0	> 3.5	MRO-MRV 63	15380	137.3	127.5	17.00	26.9670		

**MRO/MRV - 1400 rpm**

P <sub>1</sub> [kW]	i <sub>n</sub>	i <sub>r</sub>	n <sub>2</sub> [rpm]	M <sub>2</sub> [Nm]	FS	Tipo - Size - Größe	F <sub>r2</sub> [N]	MRO/V [kg]	FRO/V [kg]	J <sub>m</sub> × 10 <sup>-4</sup>	J <sub>1</sub> × 10 <sup>-4</sup>
0.75	20.0	19.15	73.1	91.1	1.9	MRO-MRV 13	3670	16.7	6.9	17.00	0.5770
		20.55	68.1	96.9	3.2	MRO-MRV 23	3720	21.1	11.3	17.00	0.7790
		19.10	73.3	91.4	> 3.5	MRO-MRV 33	5730	26.0	16.2	17.00	2.3640
		20.22	69.2	97.5	> 3.5	MRO-MRV 43	7980	50.8	41.0	17.00	5.5318
		20.53	68.2	98.4	> 3.5	MRO-MRV 53	8650	86.4	76.6	17.00	29.1621
		20.36	68.8	97.8	> 3.5	MRO-MRV 63	14100	137.3	127.5	17.00	31.0610
	22.4	23.33	60	115.9	1.5	MRO-MRV 13	3820	16.7	6.9	17.00	0.5510
		21.91	63.9	106.6	2.5	MRO-MRV 23	4420	21.1	11.3	17.00	0.6310
		21.67	64.6	103.1	> 3.5	MRO-MRV 33	5740	26.0	16.2	17.00	2.5320
		21.94	63.8	105.6	> 3.5	MRO-MRV 43	8310	50.8	41.0	17.00	4.6963
		22.85	61.3	109.8	> 3.5	MRO-MRV 53	11180	86.4	76.6	17.00	26.9452
		22.66	61.8	108.6	> 3.5	MRO-MRV 63	16460	137.3	127.5	17.00	24.2220
25.0	24.44	57.3	117.2	1.3	MRO-MRV 13	4150	16.7	6.9	17.00	0.4940	
	26.07	53.7	122.4	2.5	MRO-MRV 23	3930	21.1	11.3	17.00	0.7150	
	26.73	52.4	127.3	> 3.5	MRO-MRV 33	5730	26.0	16.2	17.00	2.0370	
	26.10	53.6	126.0	> 3.5	MRO-MRV 43	8690	50.8	41.0	17.00	5.1123	
	26.97	51.9	129.1	> 3.5	MRO-MRV 53	8140	86.4	76.6	17.00	27.9078	
	25.48	55	122.3	> 3.5	MRO-MRV 63	16820	137.3	127.5	17.00	25.3770	
28.0	29.18	48	140.1	1.2	MRO-MRV 13	3960	16.7	6.9	17.00	0.5290	
	27.39	51.1	129.2	2.4	MRO-MRV 23	4180	21.1	11.3	17.00	0.5920	
	28.74	48.7	136.4	2.9	MRO-MRV 33	5740	26.0	16.2	17.00	1.9940	
	27.92	50.1	134.3	> 3.5	MRO-MRV 43	8990	50.8	41.0	17.00	4.4508	
	27.68	50.6	133.0	> 3.5	MRO-MRV 53	9800	86.4	76.6	17.00	26.4183	
	27.45	51	132.2	> 3.5	MRO-MRV 63	15700	137.3	127.5	17.00	22.6360	
31.5	31.82	44	152.8	1.1	MRO-MRV 13	4120	16.7	6.9	17.00	0.4770	
	32.97	42.5	162.5	1.6	MRO-MRV 23	4960	21.1	11.3	17.00	0.5440	
	33.27	42.1	158.7	3.5	MRO-MRV 33	5740	26.0	16.2	17.00	2.2750	
	32.52	43.1	155.2	> 3.5	MRO-MRV 43	9390	50.8	41.0	17.00	4.8644	
	31.69	44.2	151.8	> 3.5	MRO-MRV 53	8230	86.4	76.6	17.00	27.3913	
	31.85	44	153.2	> 3.5	MRO-MRV 63	11540	137.3	127.5	17.00	25.5240	
35.5	37.95	36.9	181.8	0.9	MRO-MRV 13	4430	16.7	6.9	17.00	0.5120	
	35.06	39.9	166.1	1.9	MRO-MRV 23	4220	21.1	11.3	17.00	0.5620	
	34.26	40.9	168.0	3.3	MRO-MRV 33	5740	26.0	16.2	17.00	1.9540	
	34.06	41.1	161.5	> 3.5	MRO-MRV 43	9580	50.8	41.0	17.00	4.3066	
	34.12	41	164.6	> 3.5	MRO-MRV 53	8340	86.4	76.6	17.00	25.9891	
	33.83	41.4	162.7	> 3.5	MRO-MRV 63	13920	137.3	127.5	17.00	21.3370	
40.0	40.25	34.8	193.0	0.9	MRO-MRV 13	4100	16.7	6.9	17.00	0.4670	
	41.21	34	193.8	1.6	MRO-MRV 23	4600	21.1	11.3	17.00	0.5270	
	40.23	34.8	194.3	2.9	MRO-MRV 33	5740	26.0	16.2	17.00	1.8490	
	41.65	33.6	199.2	> 3.5	MRO-MRV 53	8510	86.4	76.6	17.00	25.4059	
	42.78	32.7	204.9	> 3.5	MRO-MRV 63	11390	137.3	127.5	17.00	20.2710	
	45.0	47.88	29.2	231.8	0.7	MRO-MRV 13	4300	16.7	6.9	17.00	0.4540
45.0	43.18	32.4	211.4	1.5	MRO-MRV 23	4450	21.1	11.3	17.00	0.5440	
	45.54	30.7	213.8	2.7	MRO-MRV 33	5740	26.0	16.2	17.00	1.8890	
	42.50	32.9	203.2	> 3.5	MRO-MRV 43	10020	50.8	41.0	17.00	4.1893	
	43.14	32.5	205.6	> 3.5	MRO-MRV 53	8540	86.4	76.6	17.00	25.6370	
	42.95	32.6	207.1	> 3.5	MRO-MRV 63	16450	137.3	127.5	17.00	23.3660	
	50.0	49.02	28.6	234.4	0.7	MRO-MRV 13	4100	16.7	6.9	17.00	0.4610
50.0	52.75	26.5	252.7	1.2	MRO-MRV 23	4680	21.1	11.3	17.00	0.5130	
	51.55	27.2	241.7	2.4	MRO-MRV 33	5740	26.0	16.2	17.00	1.8120	

**MRO/MRV - 1400 rpm**

P <sub>1</sub> [kW]	i <sub>n</sub>	i <sub>r</sub>	n <sub>2</sub> [rpm]	M <sub>2</sub> [Nm]	FS	Tipo - Size - Größe	F <sub>r2</sub> [N]	MRO/V [kg]	FRO/V [kg]	J <sub>m</sub> × 10 <sup>-4</sup>	J <sub>1</sub> × 10 <sup>-4</sup>	
0.75	50.0	51.25	27.3	245.0	> 3.5	MRO-MRV 43	9720	50.8	41.0	17.00	4.0217	
		51.34	27.3	248.1	> 3.5	MRO-MRV 53	8720	86.4	76.6	17.00	25.2163	
56.0	56.0	50.91	27.5	244.7	> 3.5	MRO-MRV 63	9810	137.3	127.5	17.00	18.9780	
		54.78	25.6	264.2	1.2	MRO-MRV 23	4720	21.1	11.3	17.00	0.5290	
		53.60	26.1	255.9	2.3	MRO-MRV 33	5740	26.0	16.2	17.00	1.8620	
		54.84	25.5	262.5	> 3.5	MRO-MRV 43	9800	50.8	41.0	17.00	4.0943	
		56.67	24.7	270.3	> 3.5	MRO-MRV 53	8820	86.4	76.6	17.00	25.3529	
63.0	63.0	56.19	24.9	271.0	> 3.5	MRO-MRV 63	9970	137.3	127.5	17.00	19.4030	
		64.97	21.5	314.2	1.0	MRO-MRV 23	4930	21.1	11.3	17.00	0.5050	
		64.33	21.8	307.5	1.3	MRO-MRV 33	5740	26.0	16.2	17.00	1.8750	
		63.95	21.9	309.4	3.2	MRO-MRV 43	10090	50.8	41.0	17.00	3.9699	
		64.91	21.6	310.7	> 3.5	MRO-MRV 53	8950	86.4	76.6	17.00	25.0608	
71.0	71.0	64.36	21.8	311.1	> 3.5	MRO-MRV 63	10200	137.3	127.5	17.00	18.5080	
		73.98	18.9	356.3	0.8	MRO-MRV 23	5510	21.1	11.3	17.00	0.4950	
		68.52	20.4	334.6	1.7	MRO-MRV 33	5740	26.0	16.2	17.00	1.7840	
		68.34	20.5	328.6	2.8	MRO-MRV 43	10970	50.8	41.0	17.00	4.0382	
		72.56	19.3	345.8	> 3.5	MRO-MRV 53	10800	86.4	76.6	17.00	25.1812	
80.0	80.0	73.41	19.1	353.3	> 3.5	MRO-MRV 63	11430	137.3	127.5	17.00	18.8420	
		82.42	17	394.1	0.8	MRO-MRV 23	5100	21.1	11.3	17.00	0.4990	
		80.65	17.4	395.5	1.5	MRO-MRV 33	5740	26.0	16.2	17.00	1.7720	
		82.52	17	394.7	2.5	MRO-MRV 43	10510	50.8	41.0	17.00	3.9279	
		79.37	17.6	384.0	3.3	MRO-MRV 53	16160	86.4	76.6	17.00	25.0122	
90.0	90.0	84.55	16.6	406.5	> 3.5	MRO-MRV 63	11400	137.3	127.5	17.00	18.1240	
		91.94	15.2	439.3	0.9	MRO-MRV 33	5740	26.0	16.2	17.00	1.8090	
		89.69	15.6	417.2	2.1	MRO-MRV 43	11880	50.8	41.0	17.00	3.8846	
		91.04	15.4	442.5	> 3.5	MRO-MRV 53	8400	86.4	76.6	17.00	24.8176	
		90.27	15.5	434.5	> 3.5	MRO-MRV 63	11400	137.3	127.5	17.00	17.8220	
100.0	100.0	105.20	13.3	505.8	1.1	MRO-MRV 33	5750	26.0	16.2	17.00	1.7580	
		102.83	13.6	503.6	1.9	MRO-MRV 43	11740	50.8	41.0	17.00	3.9031	
		100.20	14	476.8	> 3.5	MRO-MRV 53	8000	86.4	76.6	17.00	24.8837	
		100.70	13.9	484.6	> 3.5	MRO-MRV 63	9800	137.3	127.5	17.00	17.9540	
		112.0	113.11	12.4	543.8	1.1	MRO-MRV 33	5740	26.0	16.2	17.00	1.7370
112.0	112.0	115.73	12.1	546.4	1.9	MRO-MRV 43	11130	50.8	41.0	17.00	3.8632	
		109.18	12.8	531.3	3.2	MRO-MRV 53	11200	86.4	76.6	17.00	24.8595	
		118.58	11.8	572.7	> 3.5	MRO-MRV 63	9800	137.3	127.5	17.00	17.6270	
		125.0	125.46	11.16	600.0	0.8	MRO-MRV 33	5740	26.0	16.2	17.00	1.7510
		121.80	11.5	585.0	1.3	MRO-MRV 43	13730	50.8	41.0	17.00	3.9785	
125.0	125.0	119.59	11.7	583.7	3.1	MRO-MRV 53	7200	86.4	76.6	17.00	24.7730	
		128.72	10.9	622.5	> 3.5	MRO-MRV 63	22060	137.3	127.5	17.00	17.7600	
		140.0	147.54	9.49	713.1	0.8	MRO-MRV 33	5740	26.0	16.2	17.00	1.7300
		144.22	9.71	712.5	1.3	MRO-MRV 43	12410	50.8	41.0	17.00	3.8506	
		140.53	10	671.3	2.7	MRO-MRV 53	7200	86.4	76.6	17.00	24.7467	
140.0	140.0	141.23	9.9	681.1	> 3.5	MRO-MRV 63	9800	137.3	127.5	17.00	17.5400	
		160.0	164.63	8.5	792.3	0.9	MRO-MRV 43	14400	50.8	41.0	17.00	3.8831
		153.12	9.14	716.7	2.4	MRO-MRV 53	10100	86.4	76.6	17.00	24.7344	
		154.91	9.04	741.2	> 3.5	MRO-MRV 63	9800	137.3	127.5	17.00	17.5010	
		180.0	183.27	7.64	884.3	0.9	MRO-MRV 43	14710	50.8	41.0	17.00	3.8768
180.0	180.0	185.17	7.56	887.5	1.6	MRO-MRV 53	17640	86.4	76.6	17.00	24.7124	
		190.49	7.35	930.7	2.9	MRO-MRV 63	19400	137.3	127.5	17.00	17.4310	
		200.0	190.66	7.34	922.1	0.8	MRO-MRV 43	14830	50.8	41.0	17.00	3.8477



**MRO/MRV - 1400 rpm**

P <sub>1</sub> [kW]	i <sub>n</sub>	i <sub>r</sub>	n <sub>2</sub> [rpm]	M <sub>2</sub> [Nm]	FS	Tipo - Size - Größe	F <sub>r2</sub> [N]	MRO/V [kg]	FRO/V [kg]	J <sub>m</sub> × 10 <sup>-4</sup>	J <sub>1</sub> × 10 <sup>-4</sup>	
0.75	200.0	208.05	6.73	997.5	1.3	MRO-MRV 53	19060	86.4	76.6	17.00	24.7277	
	224.0	224.24	6.24	1084.2	1.2	MRO-MRV 53	19100	86.4	76.6	17.00	24.7733	
		220.89	6.34	1062.5	2.4	MRO-MRV 63	22500	137.3	127.5	17.00	17.4800	
	250.0	251.60	5.56	1216.5	1.1	MRO-MRV 53	19100	86.4	76.6	17.00	24.7078	
	280.0	271.62	5.15	1275.0	2.0	MRO-MRV 63	22500	137.3	127.5	17.00	17.4170	
	315.0	314.50	4.45	1511.4	0.9	MRO-MRV 53	19100	86.4	76.6	17.00	24.6906	
	315.0	305.43	4.58	1471.2	1.7	MRO-MRV 63	22500	137.3	127.5	17.00	17.3880	
1.1	6.3	6.62	211.4	46.8	> 3.5	MRO-MRV 23	3350	23.3	11.3	33.00	1.7940	
		6.43	217.6	45.3	> 3.5	MRO-MRV 33	4550	28.2	16.2	33.00	5.3400	
		6.60	212.1	46.6	> 3.5	MRO-MRV 43	5570	53.0	41.0	33.00	11.5009	
		6.48	215.9	45.7	> 3.5	MRO-MRV 53	8020	88.6	76.6	33.00	46.0154	
		6.43	217.7	45.3	> 3.5	MRO-MRV 63	10740	139.5	127.5	33.00	78.1860	
	7.1	7.58	185	53.0	53.0	2.5	MRO-MRV 13	3310	18.9	6.9	33.00	0.9150
		8.0	8.47	165.3	59.0	> 3.5	MRO-MRV 23	3620	23.3	11.3	33.00	1.3930
			8.25	169.7	58.2	> 3.5	MRO-MRV 33	5540	28.2	16.2	33.00	4.2720
			8.35	167.6	58.9	> 3.5	MRO-MRV 43	6000	53.0	41.0	33.00	9.2271
			8.57	163.3	60.5	> 3.5	MRO-MRV 53	8770	88.6	76.6	33.00	38.9230
	8.50	164.7	60.0	> 3.5	MRO-MRV 63	11850	139.5	127.5	33.00	60.6320		
		9.0	9.14	153	65.0	2.0	MRO-MRV 13	3740	18.9	6.9	33.00	0.8480
			8.97	156	63.5	> 3.5	MRO-MRV 23	3710	23.3	11.3	33.00	1.5320
			9.09	154	64.3	> 3.5	MRO-MRV 33	5710	28.2	16.2	33.00	4.6310
			8.72	160.6	61.6	> 3.5	MRO-MRV 43	5980	53.0	41.0	33.00	10.1119
	10.0	9.57	146	67.0	2.1	MRO-MRV 13	3600	18.9	6.9	33.00	0.7740	
		10.43	134.3	72.8	3.4	MRO-MRV 23	3870	23.3	11.3	33.00	1.1640	
		10.17	137.7	71.4	> 3.5	MRO-MRV 33	5630	28.2	16.2	33.00	3.6570	
		10.43	134.2	73.7	> 3.5	MRO-MRV 43	6430	53.0	41.0	33.00	7.7706	
		10.87	128.8	76.9	> 3.5	MRO-MRV 53	9470	88.6	76.6	33.00	34.9392	
		10.78	129.9	76.0	> 3.5	MRO-MRV 63	12750	139.5	127.5	33.00	48.5070	
	11.2	11.63	120	82.5	1.8	MRO-MRV 13	3570	18.9	6.9	33.00	0.6940	
		11.48	122	81.6	2.8	MRO-MRV 23	4040	23.3	11.3	33.00	1.2320	
		11.65	120.2	82.0	> 3.5	MRO-MRV 33	5730	28.2	16.2	33.00	3.8410	
		11.04	126.8	77.7	> 3.5	MRO-MRV 43	6520	53.0	41.0	33.00	8.3593	
		12.5	13.03	107.4	91.7	3.0	MRO-MRV 23	3920	23.3	11.3	33.00	0.9900
	12.72		110	90.0	> 3.5	MRO-MRV 33	5710	28.2	16.2	33.00	3.1860	
	13.29		105.4	93.3	> 3.5	MRO-MRV 43	6950	53.0	41.0	33.00	6.6865	
	13.17		106.3	92.8	> 3.5	MRO-MRV 53	10050	88.6	76.6	33.00	32.6124	
	13.06		107.2	92.0	> 3.5	MRO-MRV 63	13550	139.5	127.5	33.00	41.5040	
	14.0		14.02	100	95.3	1.4	MRO-MRV 13	4040	18.9	6.9	33.00	0.6660
		14.13	99.1	101.2	2.3	MRO-MRV 23	4340	23.3	11.3	33.00	1.0580	
		13.52	103.5	95.5	> 3.5	MRO-MRV 33	5520	28.2	16.2	33.00	2.5250	
		13.87	100.9	97.7	> 3.5	MRO-MRV 43	7190	53.0	41.0	33.00	5.5410	
		13.63	102.7	96.3	> 3.5	MRO-MRV 53	10340	88.6	76.6	33.00	29.4533	
		13.51	103.6	95.4	> 3.5	MRO-MRV 63	14110	139.5	127.5	33.00	30.9420	
	16.0	15.14	92.5	106.8	1.5	MRO-MRV 13	3550	18.9	6.9	33.00	0.6210	
		16.68	83.9	115.7	2.6	MRO-MRV 23	3620	23.3	11.3	33.00	0.8580	
		16.30	85.9	114.2	> 3.5	MRO-MRV 33	5730	28.2	16.2	33.00	2.8190	
		16.21	86.4	114.7	> 3.5	MRO-MRV 43	7420	53.0	41.0	33.00	6.0497	
		16.24	86.2	114.7	> 3.5	MRO-MRV 53	10150	88.6	76.6	33.00	30.7169	
		16.10	87	113.4	> 3.5	MRO-MRV 63	14450	139.5	127.5	33.00	35.7680	
18.0		18.25	76.7	123.8	1.1	MRO-MRV 13	4240	18.9	6.9	33.00	0.6040	

**MRO/MRV - 1400 rpm**

P <sub>1</sub> [kW]	i <sub>n</sub>	i <sub>r</sub>	n <sub>2</sub> [rpm]	M <sub>2</sub> [Nm]	FS	Tipo - Size - Größe	F <sub>r2</sub> [N]	MRO/V [kg]	FRO/V [kg]	J <sub>m</sub> × 10 <sup>-4</sup>	J <sub>1</sub> × 10 <sup>-4</sup>	
1.1	18.0	17.80	78.6	125.0	2.0	MRO-MRV 23	4480	23.3	11.3	33.00	0.6830	
		17.33	80.8	122.0	> 3.5	MRO-MRV 33	5680	28.2	16.2	33.00	2.2830	
		17.55	79.8	124.3	> 3.5	MRO-MRV 43	7740	53.0	41.0	33.00	5.0261	
	20.0	18.02	77.7	127.3	> 3.5	MRO-MRV 53	11300	88.6	76.6	33.00	27.8473	
			17.87	78.4	126.2	> 3.5	MRO-MRV 63	15380	139.5	127.5	33.00	26.9670
			19.15	73.1	133.6	1.3	MRO-MRV 13	3670	18.9	6.9	33.00	0.5770
		22.4	20.55	68.1	142.1	2.2	MRO-MRV 23	3720	23.3	11.3	33.00	0.7790
			19.10	73.3	134.1	2.9	MRO-MRV 33	5730	28.2	16.2	33.00	2.3640
			20.22	69.2	143.0	> 3.5	MRO-MRV 43	7980	53.0	41.0	33.00	5.5318
			20.53	68.2	144.3	> 3.5	MRO-MRV 53	8650	88.6	76.6	33.00	29.1621
			20.36	68.8	143.5	> 3.5	MRO-MRV 63	14100	139.5	127.5	33.00	31.0610
			21.91	63.9	156.3	1.7	MRO-MRV 23	4420	23.3	11.3	33.00	0.6310
25.0	21.67	64.6	151.3	> 3.5	MRO-MRV 33	5740	28.2	16.2	33.00	2.5320		
		21.94	63.8	154.9	> 3.5	MRO-MRV 43	8310	53.0	41.0	33.00	4.6963	
		22.85	61.3	161.0	> 3.5	MRO-MRV 53	11180	88.6	76.6	33.00	26.9452	
	28.0	22.66	61.8	159.3	> 3.5	MRO-MRV 63	16460	139.5	127.5	33.00	24.2220	
		26.07	53.7	179.5	1.7	MRO-MRV 23	3930	23.3	11.3	33.00	0.7150	
		26.73	52.4	186.7	3.0	MRO-MRV 33	5730	28.2	16.2	33.00	2.0370	
		26.10	53.6	184.8	> 3.5	MRO-MRV 43	8690	53.0	41.0	33.00	5.1123	
		26.97	51.9	189.4	> 3.5	MRO-MRV 53	8140	88.6	76.6	33.00	27.9078	
		25.48	55	179.4	> 3.5	MRO-MRV 63	16820	139.5	127.5	33.00	25.3770	
	31.5	27.39	51.1	189.4	1.6	MRO-MRV 23	4180	23.3	11.3	33.00	0.5920	
			28.74	48.7	200.0	2.0	MRO-MRV 33	5740	28.2	16.2	33.00	1.9940
			27.92	50.1	197.0	> 3.5	MRO-MRV 43	8990	53.0	41.0	33.00	4.4508
35.5		27.68	50.6	195.0	> 3.5	MRO-MRV 53	9800	88.6	76.6	33.00	26.4183	
		27.45	51	193.9	> 3.5	MRO-MRV 63	15700	139.5	127.5	33.00	22.6360	
		32.97	42.5	238.3	1.1	MRO-MRV 23	4960	23.3	11.3	33.00	0.5440	
		33.27	42.1	232.7	2.4	MRO-MRV 33	5740	28.2	16.2	33.00	2.2750	
		32.52	43.1	227.7	> 3.5	MRO-MRV 43	9390	53.0	41.0	33.00	4.8644	
		31.69	44.2	222.7	> 3.5	MRO-MRV 53	8230	88.6	76.6	33.00	27.3913	
40.0		31.85	44	224.7	> 3.5	MRO-MRV 63	11540	139.5	127.5	33.00	25.5240	
			35.06	39.9	243.6	1.3	MRO-MRV 23	4220	23.3	11.3	33.00	0.5620
			34.26	40.9	246.4	2.3	MRO-MRV 33	5740	28.2	16.2	33.00	1.9540
	45.0	34.06	41.1	236.9	> 3.5	MRO-MRV 43	9580	53.0	41.0	33.00	4.3066	
		34.12	41	241.4	> 3.5	MRO-MRV 53	8340	88.6	76.6	33.00	25.9891	
		33.83	41.4	238.6	> 3.5	MRO-MRV 63	13920	139.5	127.5	33.00	21.3370	
		41.21	34	284.2	1.1	MRO-MRV 23	4600	23.3	11.3	33.00	0.5270	
		40.23	34.8	285.0	2.0	MRO-MRV 33	5740	28.2	16.2	33.00	1.8490	
		41.65	33.6	292.2	> 3.5	MRO-MRV 53	8510	88.6	76.6	33.00	25.4059	
	50.0	42.78	32.7	300.5	> 3.5	MRO-MRV 63	11390	139.5	127.5	33.00	20.2710	
			43.18	32.4	310.0	1.0	MRO-MRV 23	4450	23.3	11.3	33.00	0.5440
			45.54	30.7	313.5	1.8	MRO-MRV 33	5740	28.2	16.2	33.00	1.8890
55.0		42.50	32.9	298.1	2.8	MRO-MRV 43	10020	53.0	41.0	33.00	4.1893	
		43.14	32.5	301.6	> 3.5	MRO-MRV 53	8540	88.6	76.6	33.00	25.6370	
		42.95	32.6	303.7	> 3.5	MRO-MRV 63	16450	139.5	127.5	33.00	23.3660	
		51.55	27.2	354.4	1.6	MRO-MRV 33	5740	28.2	16.2	33.00	1.8120	
		51.25	27.3	359.3	2.7	MRO-MRV 43	9720	53.0	41.0	33.00	4.0217	
		51.34	27.3	363.8	> 3.5	MRO-MRV 53	8720	88.6	76.6	33.00	25.2163	
		50.91	27.5	358.8	> 3.5	MRO-MRV 63	9810	139.5	127.5	33.00	18.9780	

**MRO/MRV - 1400 rpm**

P <sub>1</sub> [kW]	i <sub>n</sub>	i <sub>r</sub>	n <sub>2</sub> [rpm]	M <sub>2</sub> [Nm]	FS	Tipo - Size - Größe	F <sub>r2</sub> [N]	MRO/V [kg]	FRO/V [kg]	J <sub>m</sub> × 10 <sup>-4</sup>	J <sub>1</sub> × 10 <sup>-4</sup>	
1.1	56.0	53.60	26.1	375.3	1.5	MRO-MRV 33	5740	28.2	16.2	33.00	1.8620	
		54.84	25.5	385.0	2.5	MRO-MRV 43	9800	53.0	41.0	33.00	4.0943	
		56.67	24.7	396.5	> 3.5	MRO-MRV 53	8820	88.6	76.6	33.00	25.3529	
	63.0	63.0	56.19	24.9	397.4	> 3.5	MRO-MRV 63	9970	139.5	127.5	33.00	19.4030
			64.33	21.8	451.0	0.9	MRO-MRV 33	5740	28.2	16.2	33.00	1.8750
			63.95	21.9	453.8	2.2	MRO-MRV 43	10090	53.0	41.0	33.00	3.9699
	71.0	71.0	64.91	21.6	455.7	> 3.5	MRO-MRV 53	8950	88.6	76.6	33.00	25.0608
			64.36	21.8	456.3	> 3.5	MRO-MRV 63	10200	139.5	127.5	33.00	18.5080
			68.52	20.4	490.8	1.2	MRO-MRV 33	5740	28.2	16.2	33.00	1.7840
	80.0	80.0	68.34	20.5	481.9	1.9	MRO-MRV 43	10970	53.0	41.0	33.00	4.0382
			72.56	19.3	507.2	3.3	MRO-MRV 53	10800	88.6	76.6	33.00	25.1812
			73.41	19.1	518.1	> 3.5	MRO-MRV 63	11430	139.5	127.5	33.00	18.8420
	90.0	90.0	80.65	17.4	580.0	1.0	MRO-MRV 33	5740	28.2	16.2	33.00	1.7720
			82.52	17	578.9	1.7	MRO-MRV 43	10510	53.0	41.0	33.00	3.9279
			79.37	17.6	563.2	2.3	MRO-MRV 53	16160	88.6	76.6	33.00	25.0122
	100.0	100.0	84.55	16.6	596.1	> 3.5	MRO-MRV 63	11400	139.5	127.5	33.00	18.1240
			89.69	15.6	611.9	1.5	MRO-MRV 43	11880	53.0	41.0	33.00	3.8846
			91.04	15.4	649.0	2.7	MRO-MRV 53	8400	88.6	76.6	33.00	24.8176
	112.0	112.0	90.27	15.5	637.2	> 3.5	MRO-MRV 63	11400	139.5	127.5	33.00	17.8220
			102.83	13.6	738.6	1.3	MRO-MRV 43	11740	53.0	41.0	33.00	3.9031
			100.20	14	699.3	2.5	MRO-MRV 53	8000	88.6	76.6	33.00	24.8837
	125.0	125.0	100.70	13.9	710.8	> 3.5	MRO-MRV 63	9800	139.5	127.5	33.00	17.9540
			115.73	12.1	801.4	1.3	MRO-MRV 43	11130	53.0	41.0	33.00	3.8632
			109.18	12.8	779.2	2.2	MRO-MRV 53	11200	88.6	76.6	33.00	24.8595
	140.0	140.0	118.58	11.8	840.0	> 3.5	MRO-MRV 63	9800	139.5	127.5	33.00	17.6270
			119.59	11.7	856.1	2.1	MRO-MRV 53	7200	88.6	76.6	33.00	24.7730
			128.72	10.9	913.0	2.7	MRO-MRV 63	22060	139.5	127.5	33.00	17.7600
	160.0	160.0	140.53	10	984.5	1.8	MRO-MRV 53	7200	88.6	76.6	33.00	24.7467
			141.23	9.9	998.9	3.4	MRO-MRV 63	9800	139.5	127.5	33.00	17.5400
			153.12	9.14	1051.1	1.6	MRO-MRV 53	10100	88.6	76.6	33.00	24.7344
	180.0	180.0	154.91	9.04	1087.1	3.1	MRO-MRV 63	9800	139.5	127.5	33.00	17.5010
			185.17	7.56	1301.7	1.1	MRO-MRV 53	17640	88.6	76.6	33.00	24.7124
			190.49	7.35	1365.0	2.0	MRO-MRV 63	19400	139.5	127.5	33.00	17.4310
200.0	200.0	208.05	6.73	1463.0	0.9	MRO-MRV 53	19060	88.6	76.6	33.00	24.7277	
		224.0	6.24	1590.2	0.8	MRO-MRV 53	19100	88.6	76.6	33.00	24.7733	
		220.89	6.34	1558.3	1.6	MRO-MRV 63	22500	139.5	127.5	33.00	17.4800	
250.0	250.0	251.60	5.56	1784.1	0.7	MRO-MRV 53	19100	88.6	76.6	33.00	24.7078	
		280.0	5.15	1870.0	1.4	MRO-MRV 63	22500	139.5	127.5	33.00	17.4170	
		315.0	4.58	2157.7	1.2	MRO-MRV 63	22500	139.5	127.5	33.00	17.3880	
1.5	6.3	6.62	211.4	63.8	3.1	MRO-MRV 23	3350	24.8	11.3	40.00	1.7940	
		6.43	217.6	61.8	> 3.5	MRO-MRV 33	4550	29.7	16.2	40.00	5.3400	
		6.60	212.1	63.5	> 3.5	MRO-MRV 43	5570	54.5	41.0	40.00	11.5009	
		6.48	215.9	62.3	> 3.5	MRO-MRV 53	8020	90.1	76.6	40.00	46.0154	
		6.43	217.7	61.8	> 3.5	MRO-MRV 63	10740	141.0	127.5	40.00	78.1860	
	7.1	7.1	7.58	185	72.2	1.8	MRO-MRV 13	3310	20.4	6.9	40.00	0.9150
			8.0	165.3	80.5	2.7	MRO-MRV 23	3620	24.8	11.3	40.00	1.3930
	8.0	8.0	8.25	169.7	79.4	> 3.5	MRO-MRV 33	5540	29.7	16.2	40.00	4.2720
			8.35	167.6	80.3	> 3.5	MRO-MRV 43	6000	54.5	41.0	40.00	9.2271
			8.57	163.3	82.5	> 3.5	MRO-MRV 53	8770	90.1	76.6	40.00	38.9230
			8.50	164.7	81.8	> 3.5	MRO-MRV 63	11850	141.0	127.5	40.00	60.6320

### MRO/MRV - 1400 rpm

P <sub>1</sub> [kW]	i <sub>n</sub>	i <sub>r</sub>	n <sub>2</sub> [rpm]	M <sub>2</sub> [Nm]	FS	Tipo - Size - Größe	F <sub>r2</sub> [N]	MRO/V [kg]	FRO/V [kg]	J <sub>m</sub> × 10 <sup>-4</sup>	J <sub>1</sub> × 10 <sup>-4</sup>
1.5	9.0	9.14	153	88.6	1.5	MRO-MRV 13	3740	20.4	6.9	40.00	0.8480
		8.97	156	86.5	2.6	MRO-MRV 23	3710	24.8	11.3	40.00	1.5320
		9.09	154	87.7	> 3.5	MRO-MRV 33	5710	29.7	16.2	40.00	4.6310
		8.72	160.6	84.1	> 3.5	MRO-MRV 43	5980	54.5	41.0	40.00	10.1119
	10.0	9.57	146	91.3	1.5	MRO-MRV 13	3600	20.4	6.9	40.00	0.7740
		10.43	134.3	99.3	2.5	MRO-MRV 23	3870	24.8	11.3	40.00	1.1640
		10.17	137.7	97.4	> 3.5	MRO-MRV 33	5630	29.7	16.2	40.00	3.6570
		10.43	134.2	100.5	> 3.5	MRO-MRV 43	6430	54.5	41.0	40.00	7.7706
		10.87	128.8	104.8	> 3.5	MRO-MRV 53	9470	90.1	76.6	40.00	34.9392
		10.78	129.9	103.7	> 3.5	MRO-MRV 63	12750	141.0	127.5	40.00	48.5070
		11.2	11.63	120	112.5	1.3	MRO-MRV 13	3570	20.4	6.9	40.00
	11.48		122	111.3	2.1	MRO-MRV 23	4040	24.8	11.3	40.00	1.2320
	11.65		120.2	111.8	3.4	MRO-MRV 33	5730	29.7	16.2	40.00	3.8410
	11.04		126.8	106.0	> 3.5	MRO-MRV 43	6520	54.5	41.0	40.00	8.3593
	12.5	13.03	107.4	125.0	2.2	MRO-MRV 23	3920	24.8	11.3	40.00	0.9900
		12.72	110	122.7	> 3.5	MRO-MRV 33	5710	29.7	16.2	40.00	3.1860
		13.29	105.4	127.2	> 3.5	MRO-MRV 43	6950	54.5	41.0	40.00	6.6865
		13.17	106.3	126.5	> 3.5	MRO-MRV 53	10050	90.1	76.6	40.00	32.6124
		13.06	107.2	125.5	> 3.5	MRO-MRV 63	13550	141.0	127.5	40.00	41.5040
	14.0	14.02	100	130.0	1.0	MRO-MRV 13	4040	20.4	6.9	40.00	0.6660
		14.13	99.1	138.0	1.7	MRO-MRV 23	4340	24.8	11.3	40.00	1.0580
		13.52	103.5	130.2	> 3.5	MRO-MRV 33	5520	29.7	16.2	40.00	2.5250
		13.87	100.9	133.2	> 3.5	MRO-MRV 43	7190	54.5	41.0	40.00	5.5410
		13.63	102.7	131.3	> 3.5	MRO-MRV 53	10340	90.1	76.6	40.00	29.4533
13.51		103.6	130.2	> 3.5	MRO-MRV 63	14110	141.0	127.5	40.00	30.9420	
16.0		15.14	92.5	145.6	1.1	MRO-MRV 13	3550	20.4	6.9	40.00	0.6210
	16.68	83.9	157.8	1.9	MRO-MRV 23	3620	24.8	11.3	40.00	0.8580	
	16.30	85.9	155.8	3.5	MRO-MRV 33	5730	29.7	16.2	40.00	2.8190	
	16.21	86.4	156.4	> 3.5	MRO-MRV 43	7420	54.5	41.0	40.00	6.0497	
	16.24	86.2	156.4	> 3.5	MRO-MRV 53	10150	90.1	76.6	40.00	30.7169	
	16.10	87	154.6	> 3.5	MRO-MRV 63	14450	141.0	127.5	40.00	35.7680	
18.0	18.25	76.7	168.8	0.8	MRO-MRV 13	4240	20.4	6.9	40.00	0.6040	
	17.80	78.6	170.5	1.5	MRO-MRV 23	4480	24.8	11.3	40.00	0.6830	
	17.33	80.8	166.3	3.1	MRO-MRV 33	5680	29.7	16.2	40.00	2.2830	
	17.55	79.8	169.4	> 3.5	MRO-MRV 43	7740	54.5	41.0	40.00	5.0261	
	18.02	77.7	173.6	> 3.5	MRO-MRV 53	11300	90.1	76.6	40.00	27.8473	
	17.87	78.4	172.1	> 3.5	MRO-MRV 63	15380	141.0	127.5	40.00	26.9670	
20.0	19.15	73.1	182.1	0.9	MRO-MRV 13	3670	20.4	6.9	40.00	0.5770	
	20.55	68.1	193.8	1.6	MRO-MRV 23	3720	24.8	11.3	40.00	0.7790	
	19.10	73.3	182.8	2.1	MRO-MRV 33	5730	29.7	16.2	40.00	2.3640	
	20.22	69.2	195.0	> 3.5	MRO-MRV 43	7980	54.5	41.0	40.00	5.5318	
	20.53	68.2	196.7	> 3.5	MRO-MRV 53	8650	90.1	76.6	40.00	29.1621	
	20.36	68.8	195.6	> 3.5	MRO-MRV 63	14100	141.0	127.5	40.00	31.0610	
22.4	23.33	60	231.8	0.7	MRO-MRV 13	3820	20.4	6.9	40.00	0.5510	
	21.91	63.9	213.2	1.3	MRO-MRV 23	4420	24.8	11.3	40.00	0.6310	
	21.67	64.6	206.3	2.7	MRO-MRV 33	5740	29.7	16.2	40.00	2.5320	
	21.94	63.8	211.2	3.3	MRO-MRV 43	8310	54.5	41.0	40.00	4.6963	
	22.85	61.3	219.6	> 3.5	MRO-MRV 53	11180	90.1	76.6	40.00	26.9452	
	22.66	61.8	217.2	> 3.5	MRO-MRV 63	16460	141.0	127.5	40.00	24.2220	
	25.0	26.07	53.7	244.7	1.3	MRO-MRV 23	3930	24.8	11.3	40.00	0.7150

**MRO/MRV - 1400 rpm**

P <sub>1</sub> [kW]	i <sub>n</sub>	i <sub>r</sub>	n <sub>2</sub> [rpm]	M <sub>2</sub> [Nm]	FS	Tipo - Size - Größe	F <sub>r2</sub> [N]	MRO/V [kg]	FRO/V [kg]	J <sub>m</sub> × 10 <sup>-4</sup>	J <sub>1</sub> × 10 <sup>-4</sup>
1.5	25.0	26.73	52.4	254.5	2.2	MRO-MRV 33	5730	29.7	16.2	40.00	2.0370
		26.10	53.6	252.0	3.3	MRO-MRV 43	8690	54.5	41.0	40.00	5.1123
1.5	25.0	26.97	51.9	258.2	> 3.5	MRO-MRV 53	8140	90.1	76.6	40.00	27.9078
		25.48	55	244.7	> 3.5	MRO-MRV 63	16820	141.0	127.5	40.00	25.3770
		27.39	51.1	258.3	1.2	MRO-MRV 23	4180	24.8	11.3	40.00	0.5920
		28.74	48.7	272.7	1.5	MRO-MRV 33	5740	29.7	16.2	40.00	1.9940
1.5	28.0	27.92	50.1	268.6	2.9	MRO-MRV 43	8990	54.5	41.0	40.00	4.4508
		27.68	50.6	265.9	> 3.5	MRO-MRV 53	9800	90.1	76.6	40.00	26.4183
		27.45	51	264.4	> 3.5	MRO-MRV 63	15700	141.0	127.5	40.00	22.6360
		32.97	42.5	325.0	0.8	MRO-MRV 23	4960	24.8	11.3	40.00	0.5440
1.5	31.5	33.27	42.1	317.3	1.7	MRO-MRV 33	5740	29.7	16.2	40.00	2.2750
		32.52	43.1	310.5	2.9	MRO-MRV 43	9390	54.5	41.0	40.00	4.8644
		31.69	44.2	303.6	> 3.5	MRO-MRV 53	8230	90.1	76.6	40.00	27.3913
		31.85	44	306.4	> 3.5	MRO-MRV 63	11540	141.0	127.5	40.00	25.5240
1.5	35.5	35.06	39.9	332.1	0.9	MRO-MRV 23	4220	24.8	11.3	40.00	0.5620
		34.26	40.9	336.0	1.7	MRO-MRV 33	5740	29.7	16.2	40.00	1.9540
		34.06	41.1	323.1	2.6	MRO-MRV 43	9580	54.5	41.0	40.00	4.3066
		34.12	41	329.2	> 3.5	MRO-MRV 53	8340	90.1	76.6	40.00	25.9891
1.5	35.5	33.83	41.4	325.4	> 3.5	MRO-MRV 63	13920	141.0	127.5	40.00	21.3370
		41.21	34	387.5	0.8	MRO-MRV 23	4600	24.8	11.3	40.00	0.5270
		40.23	34.8	388.6	1.5	MRO-MRV 33	5740	29.7	16.2	40.00	1.8490
		41.65	33.6	398.4	> 3.5	MRO-MRV 53	8510	90.1	76.6	40.00	25.4059
1.5	40.0	42.78	32.7	409.7	> 3.5	MRO-MRV 63	11390	141.0	127.5	40.00	20.2710
		43.18	32.4	422.7	0.7	MRO-MRV 23	4450	24.8	11.3	40.00	0.5440
		45.54	30.7	427.5	1.3	MRO-MRV 33	5740	29.7	16.2	40.00	1.8890
		42.50	32.9	406.5	2.1	MRO-MRV 43	10020	54.5	41.0	40.00	4.1893
1.5	45.0	43.14	32.5	411.3	> 3.5	MRO-MRV 53	8540	90.1	76.6	40.00	25.6370
		42.95	32.6	414.1	> 3.5	MRO-MRV 63	16450	141.0	127.5	40.00	23.3660
		51.55	27.2	483.3	1.2	MRO-MRV 33	5740	29.7	16.2	40.00	1.8120
		51.25	27.3	490.0	2.0	MRO-MRV 43	9720	54.5	41.0	40.00	4.0217
1.5	50.0	51.34	27.3	496.2	3.5	MRO-MRV 53	8720	90.1	76.6	40.00	25.2163
		50.91	27.5	489.3	> 3.5	MRO-MRV 63	9810	141.0	127.5	40.00	18.9780
		56.0	26.1	511.8	1.1	MRO-MRV 33	5740	29.7	16.2	40.00	1.8620
		54.84	25.5	525.0	1.9	MRO-MRV 43	9800	54.5	41.0	40.00	4.0943
1.5	50.0	56.67	24.7	540.6	3.2	MRO-MRV 53	8820	90.1	76.6	40.00	25.3529
		56.19	24.9	541.9	> 3.5	MRO-MRV 63	9970	141.0	127.5	40.00	19.4030
		63.0	21.8	615.0	0.7	MRO-MRV 33	5740	29.7	16.2	40.00	1.8750
		63.95	21.9	618.8	1.6	MRO-MRV 43	10090	54.5	41.0	40.00	3.9699
1.5	63.0	64.91	21.6	621.4	2.8	MRO-MRV 53	8950	90.1	76.6	40.00	25.0608
		64.36	21.8	622.2	> 3.5	MRO-MRV 63	10200	141.0	127.5	40.00	18.5080
		71.0	20.4	669.2	0.9	MRO-MRV 33	5740	29.7	16.2	40.00	1.7840
		68.34	20.5	657.1	1.4	MRO-MRV 43	10970	54.5	41.0	40.00	4.0382
1.5	71.0	72.56	19.3	691.7	2.4	MRO-MRV 53	10800	90.1	76.6	40.00	25.1812
		73.41	19.1	706.5	> 3.5	MRO-MRV 63	11430	141.0	127.5	40.00	18.8420
		80.0	17.4	790.9	0.7	MRO-MRV 33	5740	29.7	16.2	40.00	1.7720
		82.52	17	789.5	1.3	MRO-MRV 43	10510	54.5	41.0	40.00	3.9279
1.5	80.0	79.37	17.6	768.0	1.7	MRO-MRV 53	16160	90.1	76.6	40.00	25.0122
		84.55	16.6	812.9	> 3.5	MRO-MRV 63	11400	141.0	127.5	40.00	18.1240
		90.0	15.6	834.4	1.1	MRO-MRV 43	11880	54.5	41.0	40.00	3.8846
		91.04	15.4	885.0	2.0	MRO-MRV 53	8400	90.1	76.6	40.00	24.8176

### MRO/MRV - 1400 rpm

P <sub>1</sub> [kW]	i <sub>n</sub>	i <sub>r</sub>	n <sub>2</sub> [rpm]	M <sub>2</sub> [Nm]	FS	Tipo - Size - Größe	F <sub>r2</sub> [N]	MRO/V [kg]	FRO/V [kg]	J <sub>m</sub> × 10 <sup>-4</sup>	J <sub>1</sub> × 10 <sup>-4</sup>
1.5	90.0	90.27	15.5	869.0	> 3.5	MRO-MRV 63	11400	141.0	127.5	40.00	17.8220
		100.0	102.83	13.6	1007.1	0.9	MRO-MRV 43	11740	54.5	41.0	40.00
	112.0	100.20	14	953.6	1.9	MRO-MRV 53	8000	90.1	76.6	40.00	24.8837
		100.70	13.9	969.2	3.5	MRO-MRV 63	9800	141.0	127.5	40.00	17.9540
		115.73	12.1	1092.9	0.9	MRO-MRV 43	11130	54.5	41.0	40.00	3.8632
	125.0	109.18	12.8	1062.5	1.6	MRO-MRV 53	11200	90.1	76.6	40.00	24.8595
		118.58	11.8	1145.5	2.9	MRO-MRV 63	9800	141.0	127.5	40.00	17.6270
		119.59	11.7	1167.4	1.5	MRO-MRV 53	7200	90.1	76.6	40.00	24.7730
	140.0	128.72	10.9	1245.0	2.0	MRO-MRV 63	22060	141.0	127.5	40.00	17.7600
		140.53	10	1342.5	1.3	MRO-MRV 53	7200	90.1	76.6	40.00	24.7467
	160.0	141.23	9.9	1362.2	2.5	MRO-MRV 63	9800	141.0	127.5	40.00	17.5400
		153.12	9.14	1433.3	1.2	MRO-MRV 53	10100	90.1	76.6	40.00	24.7344
	180.0	154.91	9.04	1482.4	2.3	MRO-MRV 63	9800	141.0	127.5	40.00	17.5010
		185.17	7.56	1775.0	0.8	MRO-MRV 53	17640	90.1	76.6	40.00	24.7124
	200.0	190.49	7.35	1861.4	1.5	MRO-MRV 63	19400	141.0	127.5	40.00	17.4310
		208.05	6.73	1995.0	0.7	MRO-MRV 53	19060	90.1	76.6	40.00	24.7277
	224.0	220.89	6.34	2125.0	1.2	MRO-MRV 63	22500	141.0	127.5	40.00	17.4800
	280.0	271.62	5.15	2550.0	1.0	MRO-MRV 63	22500	141.0	127.5	40.00	17.4170
	315.0	305.43	4.58	2942.3	0.9	MRO-MRV 63	22500	141.0	127.5	40.00	17.3880
	2.2	6.3	6.62	211.4	93.6	2.1	MRO-MRV 23	3350	30.3	11.3	75.00
6.43			217.6	90.6	> 3.5	MRO-MRV 33	4550	35.2	16.2	75.00	5.3400
6.60			212.1	93.2	> 3.5	MRO-MRV 43	5570	60.0	41.0	75.00	11.5009
6.48			215.9	91.3	> 3.5	MRO-MRV 53	8020	95.6	76.6	75.00	46.0154
8.0		6.43	217.7	90.6	> 3.5	MRO-MRV 63	10740	146.5	127.5	75.00	78.1860
		8.47	165.3	118.0	1.9	MRO-MRV 23	3620	30.3	11.3	75.00	1.3930
		8.25	169.7	116.5	> 3.5	MRO-MRV 33	5540	35.2	16.2	75.00	4.2720
		8.35	167.6	117.8	> 3.5	MRO-MRV 43	6000	60.0	41.0	75.00	9.2271
		8.57	163.3	121.0	> 3.5	MRO-MRV 53	8770	95.6	76.6	75.00	38.9230
9.0		8.50	164.7	120.0	> 3.5	MRO-MRV 63	11850	146.5	127.5	75.00	60.6320
		8.97	156	126.9	1.8	MRO-MRV 23	3710	30.3	11.3	75.00	1.5320
		9.09	154	128.6	3.0	MRO-MRV 33	5710	35.2	16.2	75.00	4.6310
		8.72	160.6	123.3	> 3.5	MRO-MRV 43	5980	60.0	41.0	75.00	10.1119
10.0		10.43	134.3	145.7	1.7	MRO-MRV 23	3870	30.3	11.3	75.00	1.1640
		10.17	137.7	142.9	3.5	MRO-MRV 33	5630	35.2	16.2	75.00	3.6570
		10.43	134.2	147.5	> 3.5	MRO-MRV 43	6430	60.0	41.0	75.00	7.7706
		10.87	128.8	153.8	> 3.5	MRO-MRV 53	9470	95.6	76.6	75.00	34.9392
		10.78	129.9	152.1	> 3.5	MRO-MRV 63	12750	146.5	127.5	75.00	48.5070
11.2		11.48	122	163.2	1.4	MRO-MRV 23	4040	30.3	11.3	75.00	1.2320
		11.65	120.2	163.9	2.3	MRO-MRV 33	5730	35.2	16.2	75.00	3.8410
		11.04	126.8	155.4	> 3.5	MRO-MRV 43	6520	60.0	41.0	75.00	8.3593
12.5		13.03	107.4	183.3	1.5	MRO-MRV 23	3920	30.3	11.3	75.00	0.9900
		12.72	110	180.0	3.0	MRO-MRV 33	5710	35.2	16.2	75.00	3.1860
		13.29	105.4	186.6	> 3.5	MRO-MRV 43	6950	60.0	41.0	75.00	6.6865
		13.17	106.3	185.5	> 3.5	MRO-MRV 53	10050	95.6	76.6	75.00	32.6124
14.0		13.06	107.2	184.0	> 3.5	MRO-MRV 63	13550	146.5	127.5	75.00	41.5040
		14.13	99.1	202.4	1.1	MRO-MRV 23	4340	30.3	11.3	75.00	1.0580
	13.52	103.5	190.9	2.4	MRO-MRV 33	5520	35.2	16.2	75.00	2.5250	
	13.87	100.9	195.3	2.6	MRO-MRV 43	7190	60.0	41.0	75.00	5.5410	
	13.63	102.7	192.5	> 3.5	MRO-MRV 53	10340	95.6	76.6	75.00	29.4533	
	13.51	103.6	190.9	> 3.5	MRO-MRV 63	14110	146.5	127.5	75.00	30.9420	

**MRO/MRV - 1400 rpm**

P <sub>1</sub> [kW]	i <sub>n</sub>	i <sub>r</sub>	n <sub>2</sub> [rpm]	M <sub>2</sub> [Nm]	FS	Tipo - Size - Größe	F <sub>r2</sub> [N]	MRO/V [kg]	FRO/V [kg]	J <sub>m</sub> × 10 <sup>-4</sup>	J <sub>1</sub> × 10 <sup>-4</sup>
2.2	16.0	16.68	83.9	231.4	1.3	MRO-MRV 23	3620	30.3	11.3	75.00	0.8580
		16.30	85.9	228.5	2.4	MRO-MRV 33	5730	35.2	16.2	75.00	2.8190
		16.21	86.4	229.4	3.2	MRO-MRV 43	7420	60.0	41.0	75.00	6.0497
		16.24	86.2	229.4	> 3.5	MRO-MRV 53	10150	95.6	76.6	75.00	30.7169
		16.10	87	226.8	> 3.5	MRO-MRV 63	14450	146.5	127.5	75.00	35.7680
	18.0	17.80	78.6	250.0	1.0	MRO-MRV 23	4480	30.3	11.3	75.00	0.6830
		17.33	80.8	243.9	2.1	MRO-MRV 33	5680	35.2	16.2	75.00	2.2830
		17.55	79.8	248.5	2.5	MRO-MRV 43	7740	60.0	41.0	75.00	5.0261
		18.02	77.7	254.6	> 3.5	MRO-MRV 53	11300	95.6	76.6	75.00	27.8473
		17.87	78.4	252.4	> 3.5	MRO-MRV 63	15380	146.5	127.5	75.00	26.9670
	20.0	20.55	68.1	284.2	1.1	MRO-MRV 23	3720	30.3	11.3	75.00	0.7790
		19.10	73.3	268.1	1.5	MRO-MRV 33	5730	35.2	16.2	75.00	2.3640
20.22		69.2	286.0	2.7	MRO-MRV 43	7980	60.0	41.0	75.00	5.5318	
20.53		68.2	288.5	> 3.5	MRO-MRV 53	8650	95.6	76.6	75.00	29.1621	
20.36		68.8	286.9	> 3.5	MRO-MRV 63	14100	146.5	127.5	75.00	31.0610	
22.4	21.67	64.6	302.5	1.8	MRO-MRV 33	5740	35.2	16.2	75.00	2.5320	
	21.94	63.8	309.8	2.2	MRO-MRV 43	8310	60.0	41.0	75.00	4.6963	
	22.85	61.3	322.1	> 3.5	MRO-MRV 53	11180	95.6	76.6	75.00	26.9452	
	22.66	61.8	318.6	> 3.5	MRO-MRV 63	16460	146.5	127.5	75.00	24.2220	
25.0	26.73	52.4	373.3	1.5	MRO-MRV 33	5730	35.2	16.2	75.00	2.0370	
	26.10	53.6	369.6	2.3	MRO-MRV 43	8690	60.0	41.0	75.00	5.1123	
	26.97	51.9	378.8	> 3.5	MRO-MRV 53	8140	95.6	76.6	75.00	27.9078	
	25.48	55	358.9	> 3.5	MRO-MRV 63	16820	146.5	127.5	75.00	25.3770	
28.0	28.74	48.7	400.0	1.0	MRO-MRV 33	5740	35.2	16.2	75.00	1.9940	
	27.92	50.1	394.0	2.0	MRO-MRV 43	8990	60.0	41.0	75.00	4.4508	
	27.68	50.6	390.0	> 3.5	MRO-MRV 53	9800	95.6	76.6	75.00	26.4183	
	27.45	51	387.8	> 3.5	MRO-MRV 63	15700	146.5	127.5	75.00	22.6360	
31.5	33.27	42.1	465.4	1.2	MRO-MRV 33	5740	35.2	16.2	75.00	2.2750	
	32.52	43.1	455.3	2.0	MRO-MRV 43	9390	60.0	41.0	75.00	4.8644	
	31.69	44.2	445.3	> 3.5	MRO-MRV 53	8230	95.6	76.6	75.00	27.3913	
	31.85	44	449.4	> 3.5	MRO-MRV 63	11540	146.5	127.5	75.00	25.5240	
35.5	34.26	40.9	492.8	1.1	MRO-MRV 33	5740	35.2	16.2	75.00	1.9540	
	34.06	41.1	473.8	1.8	MRO-MRV 43	9580	60.0	41.0	75.00	4.3066	
	34.12	41	482.9	3.5	MRO-MRV 53	8340	95.6	76.6	75.00	25.9891	
	33.83	41.4	477.3	> 3.5	MRO-MRV 63	13920	146.5	127.5	75.00	21.3370	
40.0	40.23	34.8	570.0	1.0	MRO-MRV 33	5740	35.2	16.2	75.00	1.8490	
	41.65	33.6	584.4	2.9	MRO-MRV 53	8510	95.6	76.6	75.00	25.4059	
	42.78	32.7	600.9	> 3.5	MRO-MRV 63	11390	146.5	127.5	75.00	20.2710	
45.0	42.50	32.9	596.1	1.4	MRO-MRV 43	10020	60.0	41.0	75.00	4.1893	
	43.14	32.5	603.2	2.8	MRO-MRV 53	8540	95.6	76.6	75.00	25.6370	
	42.95	32.6	607.4	> 3.5	MRO-MRV 63	16450	146.5	127.5	75.00	23.3660	
50.0	51.25	27.3	718.7	1.4	MRO-MRV 43	9720	60.0	41.0	75.00	4.0217	
	51.34	27.3	727.7	2.4	MRO-MRV 53	8720	95.6	76.6	75.00	25.2163	
	50.91	27.5	717.7	> 3.5	MRO-MRV 63	9810	146.5	127.5	75.00	18.9780	
56.0	54.84	25.5	770.0	1.3	MRO-MRV 43	9800	60.0	41.0	75.00	4.0943	
	56.67	24.7	792.9	2.2	MRO-MRV 53	8820	95.6	76.6	75.00	25.3529	
	56.19	24.9	794.8	> 3.5	MRO-MRV 63	9970	146.5	127.5	75.00	19.4030	
63.0	63.95	21.9	907.5	1.1	MRO-MRV 43	10090	60.0	41.0	75.00	3.9699	
	64.91	21.6	911.4	1.9	MRO-MRV 53	8950	95.6	76.6	75.00	25.0608	
	64.36	21.8	912.6	> 3.5	MRO-MRV 63	10200	146.5	127.5	75.00	18.5080	

### MRO/MRV - 1400 rpm

P <sub>1</sub> [kW]	i <sub>n</sub>	i <sub>r</sub>	n <sub>2</sub> [rpm]	M <sub>2</sub> [Nm]	FS	Tipo - Size - Größe	F <sub>r2</sub> [N]	MRO/V [kg]	FRO/V [kg]	J <sub>m</sub> × 10 <sup>-4</sup>	J <sub>1</sub> × 10 <sup>-4</sup>
2.2	71.0	72.56	19.3	1014.4	1.6	MRO-MRV 53	10800	95.6	76.6	75.00	25.1812
		73.41	19.1	1036.2	3.1	MRO-MRV 63	11430	146.5	127.5	75.00	18.8420
	80.0	79.37	17.6	1126.4	1.1	MRO-MRV 53	16160	95.6	76.6	75.00	25.0122
		84.55	16.6	1192.3	2.8	MRO-MRV 63	11400	146.5	127.5	75.00	18.1240
	90.0	91.04	15.4	1298.0	1.4	MRO-MRV 53	8400	95.6	76.6	75.00	24.8176
		90.27	15.5	1274.5	2.6	MRO-MRV 63	11400	146.5	127.5	75.00	17.8220
	100.0	100.20	14	1398.6	1.3	MRO-MRV 53	8000	95.6	76.6	75.00	24.8837
		100.70	13.9	1421.5	2.4	MRO-MRV 63	9800	146.5	127.5	75.00	17.9540
	112.0	109.18	12.8	1558.3	1.1	MRO-MRV 53	11200	95.6	76.6	75.00	24.8595
		118.58	11.8	1680.0	2.0	MRO-MRV 63	9800	146.5	127.5	75.00	17.6270
	125.0	119.59	11.7	1712.2	1.0	MRO-MRV 53	7200	95.6	76.6	75.00	24.7730
		128.72	10.9	1826.0	1.4	MRO-MRV 63	22060	146.5	127.5	75.00	17.7600
	140.0	141.23	9.9	1997.8	1.7	MRO-MRV 63	9800	146.5	127.5	75.00	17.5400
	160.0	154.91	9.04	2174.1	1.5	MRO-MRV 63	9800	146.5	127.5	75.00	17.5010
180.0	190.49	7.35	2730.0	1.0	MRO-MRV 63	19400	146.5	127.5	75.00	17.4310	
3	6.3	6.62	211.4	127.7	1.6	MRO-MRV 23	3350	32.3	11.3	85.00	1.7940
		6.43	217.6	123.5	3.4	MRO-MRV 33	4550	37.2	16.2	85.00	5.3400
		6.60	212.1	127.0	> 3.5	MRO-MRV 43	5570	62.0	41.0	85.00	11.5009
		6.48	215.9	124.6	> 3.5	MRO-MRV 53	8020	97.6	76.6	85.00	46.0154
	8.0	6.43	217.7	123.6	> 3.5	MRO-MRV 63	10740	148.5	127.5	85.00	78.1860
		8.47	165.3	161.0	1.4	MRO-MRV 23	3620	32.3	11.3	85.00	1.3930
		8.25	169.7	158.8	2.8	MRO-MRV 33	5540	37.2	16.2	85.00	4.2720
		8.35	167.6	160.6	3.3	MRO-MRV 43	6000	62.0	41.0	85.00	9.2271
	9.0	8.57	163.3	165.0	> 3.5	MRO-MRV 53	8770	97.6	76.6	85.00	38.9230
		8.50	164.7	163.6	> 3.5	MRO-MRV 63	11850	148.5	127.5	85.00	60.6320
		8.97	156	173.1	1.3	MRO-MRV 23	3710	32.3	11.3	85.00	1.5320
		9.09	154	175.4	2.2	MRO-MRV 33	5710	37.2	16.2	85.00	4.6310
	10.0	8.72	160.6	168.1	> 3.5	MRO-MRV 43	5980	62.0	41.0	85.00	10.1119
		10.43	134.3	198.6	1.2	MRO-MRV 23	3870	32.3	11.3	85.00	1.1640
		10.17	137.7	194.8	2.6	MRO-MRV 33	5630	37.2	16.2	85.00	3.6570
		10.43	134.2	201.1	3.0	MRO-MRV 43	6430	62.0	41.0	85.00	7.7706
	11.2	10.87	128.8	209.7	> 3.5	MRO-MRV 53	9470	97.6	76.6	85.00	34.9392
		10.78	129.9	207.4	> 3.5	MRO-MRV 63	12750	148.5	127.5	85.00	48.5070
		11.48	122	222.6	1.0	MRO-MRV 23	4040	32.3	11.3	85.00	1.2320
		11.65	120.2	223.5	1.7	MRO-MRV 33	5730	37.2	16.2	85.00	3.8410
	12.5	11.04	126.8	212.0	3.1	MRO-MRV 43	6520	62.0	41.0	85.00	8.3593
		13.03	107.4	250.0	1.1	MRO-MRV 23	3920	32.3	11.3	85.00	0.9900
		12.72	110	245.5	2.2	MRO-MRV 33	5710	37.2	16.2	85.00	3.1860
		13.29	105.4	254.4	2.6	MRO-MRV 43	6950	62.0	41.0	85.00	6.6865
	14.0	13.17	106.3	253.0	> 3.5	MRO-MRV 53	10050	97.6	76.6	85.00	32.6124
		13.06	107.2	251.0	> 3.5	MRO-MRV 63	13550	148.5	127.5	85.00	41.5040
		14.13	99.1	276.0	0.8	MRO-MRV 23	4340	32.3	11.3	85.00	1.0580
		13.52	103.5	260.4	1.8	MRO-MRV 33	5520	37.2	16.2	85.00	2.5250
	16.0	13.87	100.9	266.4	1.9	MRO-MRV 43	7190	62.0	41.0	85.00	5.5410
		13.63	102.7	262.5	> 3.5	MRO-MRV 53	10340	97.6	76.6	85.00	29.4533
		13.51	103.6	260.3	> 3.5	MRO-MRV 63	14110	148.5	127.5	85.00	30.9420
		16.68	83.9	315.5	1.0	MRO-MRV 23	3620	32.3	11.3	85.00	0.8580
16.30		85.9	311.5	1.7	MRO-MRV 33	5730	37.2	16.2	85.00	2.8190	
16.21		86.4	312.9	2.3	MRO-MRV 43	7420	62.0	41.0	85.00	6.0497	
16.24	86.2	312.8	> 3.5	MRO-MRV 53	10150	97.6	76.6	85.00	30.7169		



**MRO/MRV - 1400 rpm**

P <sub>1</sub> [kW]	i <sub>n</sub>	i <sub>r</sub>	n <sub>2</sub> [rpm]	M <sub>2</sub> [Nm]	FS	Tipo - Size - Größe	F <sub>r2</sub> [N]	MRO/V [kg]	FRO/V [kg]	J <sub>m</sub> × 10 <sup>-4</sup>	J <sub>1</sub> × 10 <sup>-4</sup>	
3	16.0	16.10	87	309.3	> 3.5	MRO-MRV 63	14450	148.5	127.5	85.00	35.7680	
		17.80	78.6	340.9	0.7	MRO-MRV 23	4480	32.3	11.3	85.00	0.6830	
18.0	18.0	17.33	80.8	332.6	1.5	MRO-MRV 33	5680	37.2	16.2	85.00	2.2830	
		17.55	79.8	338.9	1.8	MRO-MRV 43	7740	62.0	41.0	85.00	5.0261	
		18.02	77.7	347.2	> 3.5	MRO-MRV 53	11300	97.6	76.6	85.00	27.8473	
		17.87	78.4	344.1	> 3.5	MRO-MRV 63	15380	148.5	127.5	85.00	26.9670	
20.0	20.0	20.55	68.1	387.5	0.8	MRO-MRV 23	3720	32.3	11.3	85.00	0.7790	
		19.10	73.3	365.6	1.1	MRO-MRV 33	5730	37.2	16.2	85.00	2.3640	
		20.22	69.2	390.0	2.0	MRO-MRV 43	7980	62.0	41.0	85.00	5.5318	
		20.53	68.2	393.4	> 3.5	MRO-MRV 53	8650	97.6	76.6	85.00	29.1621	
		20.36	68.8	391.2	> 3.5	MRO-MRV 63	14100	148.5	127.5	85.00	31.0610	
		22.4	21.67	64.6	412.5	1.3	MRO-MRV 33	5740	37.2	16.2	85.00	2.5320
22.4	22.4	21.94	63.8	422.4	1.6	MRO-MRV 43	8310	62.0	41.0	85.00	4.6963	
		22.85	61.3	439.2	3.2	MRO-MRV 53	11180	97.6	76.6	85.00	26.9452	
		22.66	61.8	434.4	> 3.5	MRO-MRV 63	16460	148.5	127.5	85.00	24.2220	
		25.0	26.73	52.4	509.1	1.1	MRO-MRV 33	5730	37.2	16.2	85.00	2.0370
25.0	25.0	26.10	53.6	504.0	1.7	MRO-MRV 43	8690	62.0	41.0	85.00	5.1123	
		26.97	51.9	516.5	3.2	MRO-MRV 53	8140	97.6	76.6	85.00	27.9078	
		25.48	55	489.4	> 3.5	MRO-MRV 63	16820	148.5	127.5	85.00	25.3770	
		28.0	28.74	48.7	545.5	0.7	MRO-MRV 33	5740	37.2	16.2	85.00	1.9940
28.0	28.0	27.92	50.1	537.2	1.4	MRO-MRV 43	8990	62.0	41.0	85.00	4.4508	
		27.68	50.6	531.8	2.9	MRO-MRV 53	9800	97.6	76.6	85.00	26.4183	
		27.45	51	528.8	> 3.5	MRO-MRV 63	15700	148.5	127.5	85.00	22.6360	
		31.5	33.27	42.1	634.6	0.9	MRO-MRV 33	5740	37.2	16.2	85.00	2.2750
31.5	31.5	32.52	43.1	620.9	1.4	MRO-MRV 43	9390	62.0	41.0	85.00	4.8644	
		31.69	44.2	607.2	2.8	MRO-MRV 53	8230	97.6	76.6	85.00	27.3913	
		31.85	44	612.9	> 3.5	MRO-MRV 63	11540	148.5	127.5	85.00	25.5240	
		35.5	34.26	40.9	672.0	0.8	MRO-MRV 33	5740	37.2	16.2	85.00	1.9540
35.5	35.5	34.06	41.1	646.2	1.3	MRO-MRV 43	9580	62.0	41.0	85.00	4.3066	
		34.12	41	658.4	2.6	MRO-MRV 53	8340	97.6	76.6	85.00	25.9891	
		33.83	41.4	650.8	> 3.5	MRO-MRV 63	13920	148.5	127.5	85.00	21.3370	
		40.0	40.23	34.8	777.3	0.7	MRO-MRV 33	5740	37.2	16.2	85.00	1.8490
40.0	40.0	41.65	33.6	796.9	2.1	MRO-MRV 53	8510	97.6	76.6	85.00	25.4059	
		42.78	32.7	819.4	> 3.5	MRO-MRV 63	11390	148.5	127.5	85.00	20.2710	
		45.0	42.50	32.9	812.9	1.0	MRO-MRV 43	10020	62.0	41.0	85.00	4.1893
		43.14	32.5	822.6	2.1	MRO-MRV 53	8540	97.6	76.6	85.00	25.6370	
45.0	45.0	42.95	32.6	828.3	3.1	MRO-MRV 63	16450	148.5	127.5	85.00	23.3660	
		50.0	51.25	27.3	980.0	1.0	MRO-MRV 43	9720	62.0	41.0	85.00	4.0217
		51.34	27.3	992.3	1.7	MRO-MRV 53	8720	97.6	76.6	85.00	25.2163	
		50.91	27.5	978.6	3.4	MRO-MRV 63	9810	148.5	127.5	85.00	18.9780	
56.0	56.0	54.84	25.5	1050.0	0.9	MRO-MRV 43	9800	62.0	41.0	85.00	4.0943	
		56.67	24.7	1081.3	1.6	MRO-MRV 53	8820	97.6	76.6	85.00	25.3529	
		56.19	24.9	1083.9	3.1	MRO-MRV 63	9970	148.5	127.5	85.00	19.4030	
63.0	63.0	63.95	21.9	1237.5	0.8	MRO-MRV 43	10090	62.0	41.0	85.00	3.9699	
		64.91	21.6	1242.9	1.4	MRO-MRV 53	8950	97.6	76.6	85.00	25.0608	
		64.36	21.8	1244.4	2.7	MRO-MRV 63	10200	148.5	127.5	85.00	18.5080	
71.0	71.0	72.56	19.3	1383.3	1.2	MRO-MRV 53	10800	97.6	76.6	85.00	25.1812	
		73.41	19.1	1413.0	2.3	MRO-MRV 63	11430	148.5	127.5	85.00	18.8420	
80.0	80.0	79.37	17.6	1536.0	0.8	MRO-MRV 53	16160	97.6	76.6	85.00	25.0122	
		84.55	16.6	1625.8	2.1	MRO-MRV 63	11400	148.5	127.5	85.00	18.1240	

**MRO/MRV - 1400 rpm**

P <sub>1</sub> [kW]	i <sub>n</sub>	i <sub>r</sub>	n <sub>2</sub> [rpm]	M <sub>2</sub> [Nm]	FS	Tipo - Size - Größe	F <sub>r2</sub> [N]	MRO/V [kg]	FRO/V [kg]	J <sub>m</sub> × 10 <sup>-4</sup>	J <sub>1</sub> × 10 <sup>-4</sup>	
3	90.0	91.04	15.4	1770.0	1.0	MRO-MRV 53	8400	97.6	76.6	85.00	24.8176	
		90.27	15.5	1737.9	1.9	MRO-MRV 63	11400	148.5	127.5	85.00	17.8220	
	100.0	100.20	14	1907.1	0.9	MRO-MRV 53	8000	97.6	76.6	85.00	24.8837	
		100.70	13.9	1938.5	1.7	MRO-MRV 63	9800	148.5	127.5	85.00	17.9540	
	112.0	109.18	12.8	2125.0	0.8	MRO-MRV 53	11200	97.6	76.6	85.00	24.8595	
		118.58	11.8	2290.9	1.5	MRO-MRV 63	9800	148.5	127.5	85.00	17.6270	
	125.0	119.59	11.7	2334.8	0.8	MRO-MRV 53	7200	97.6	76.6	85.00	24.7730	
		128.72	10.9	2490.0	1.0	MRO-MRV 63	22060	148.5	127.5	85.00	17.7600	
	140.0	141.23	9.9	2724.3	1.2	MRO-MRV 63	9800	148.5	127.5	85.00	17.5400	
	160.0	154.91	9.04	2964.7	1.1	MRO-MRV 63	9800	148.5	127.5	85.00	17.5010	
180.0	190.49	7.35	3722.7	0.7	MRO-MRV 63	19400	148.5	127.5	85.00	17.4310		
4	6.3	6.62	211.4	170.2	1.2	MRO-MRV 23	3350	40.3	11.3	130.00	1.7940	
		6.43	217.6	164.7	2.6	MRO-MRV 33	4550	45.2	16.2	130.00	5.3400	
		6.60	212.1	169.4	2.8	MRO-MRV 43	5570	70.0	41.0	130.00	11.5009	
		6.48	215.9	166.1	> 3.5	MRO-MRV 53	8020	105.6	76.6	130.00	46.0154	
	8.0	6.43	217.7	164.8	> 3.5	MRO-MRV 63	10740	156.5	127.5	130.00	78.1860	
		8.47	165.3	214.6	1.0	MRO-MRV 23	3620	40.3	11.3	130.00	1.3930	
		8.25	169.7	211.8	2.1	MRO-MRV 33	5540	45.2	16.2	130.00	4.2720	
		8.35	167.6	214.1	2.5	MRO-MRV 43	6000	70.0	41.0	130.00	9.2271	
	9.0	8.57	163.3	220.0	> 3.5	MRO-MRV 53	8770	105.6	76.6	130.00	38.9230	
		8.50	164.7	218.2	> 3.5	MRO-MRV 63	11850	156.5	127.5	130.00	60.6320	
		9.09	154	233.8	1.6	MRO-MRV 33	5710	45.2	16.2	130.00	4.6310	
		8.72	160.6	224.1	2.9	MRO-MRV 43	5980	70.0	41.0	130.00	10.1119	
	10.0	10.17	137.7	259.7	1.9	MRO-MRV 33	5630	45.2	16.2	130.00	3.6570	
		10.43	134.2	268.1	2.3	MRO-MRV 43	6430	70.0	41.0	130.00	7.7706	
		10.87	128.8	279.5	> 3.5	MRO-MRV 53	9470	105.6	76.6	130.00	34.9392	
		10.78	129.9	276.5	> 3.5	MRO-MRV 63	12750	156.5	127.5	130.00	48.5070	
	11.2	11.65	120.2	298.0	1.3	MRO-MRV 33	5730	45.2	16.2	130.00	3.8410	
		11.04	126.8	282.6	2.3	MRO-MRV 43	6520	70.0	41.0	130.00	8.3593	
		12.72	110	327.3	1.7	MRO-MRV 33	5710	45.2	16.2	130.00	3.1860	
		13.29	105.4	339.2	2.0	MRO-MRV 43	6950	70.0	41.0	130.00	6.6865	
	12.5	13.17	106.3	337.3	> 3.5	MRO-MRV 53	10050	105.6	76.6	130.00	32.6124	
		13.06	107.2	334.6	> 3.5	MRO-MRV 63	13550	156.5	127.5	130.00	41.5040	
		14.0	13.52	103.5	347.2	1.3	MRO-MRV 33	5520	45.2	16.2	130.00	2.5250
		13.87	100.9	355.2	1.5	MRO-MRV 43	7190	70.0	41.0	130.00	5.5410	
	13.63	102.7	350.0	3.0	MRO-MRV 53	10340	105.6	76.6	130.00	29.4533		
		13.51	103.6	347.1	> 3.5	MRO-MRV 63	14110	156.5	127.5	130.00	30.9420	
		16.0	16.30	85.9	415.4	1.3	MRO-MRV 33	5730	45.2	16.2	130.00	2.8190
		16.21	86.4	417.1	1.8	MRO-MRV 43	7420	70.0	41.0	130.00	6.0497	
	16.24	86.2	417.0	> 3.5	MRO-MRV 53	10150	105.6	76.6	130.00	30.7169		
		16.10	87	412.4	> 3.5	MRO-MRV 63	14450	156.5	127.5	130.00	35.7680	
		18.0	17.33	80.8	443.5	1.2	MRO-MRV 33	5680	45.2	16.2	130.00	2.2830
		17.55	79.8	451.9	1.4	MRO-MRV 43	7740	70.0	41.0	130.00	5.0261	
	18.02	77.7	463.0	2.7	MRO-MRV 53	11300	105.6	76.6	130.00	27.8473		
		17.87	78.4	458.8	> 3.5	MRO-MRV 63	15380	156.5	127.5	130.00	26.9670	
		20.0	20.22	69.2	520.0	1.5	MRO-MRV 43	7980	70.0	41.0	130.00	5.5318
		20.53	68.2	524.6	3.1	MRO-MRV 53	8650	105.6	76.6	130.00	29.1621	
	20.36	68.8	521.6	> 3.5	MRO-MRV 63	14100	156.5	127.5	130.00	31.0610		
		22.4	21.94	63.8	563.3	1.2	MRO-MRV 43	8310	70.0	41.0	130.00	4.6963
	22.85	61.3	585.6	2.4	MRO-MRV 53	11180	105.6	76.6	130.00	26.9452		

**MRO/MRV - 1400 rpm**

P <sub>1</sub> [kW]	i <sub>n</sub>	i <sub>r</sub>	n <sub>2</sub> [rpm]	M <sub>2</sub> [Nm]	FS	Tipo - Size - Größe	F <sub>r2</sub> [N]	MRO/V [kg]	FRO/V [kg]	J <sub>m</sub> × 10 <sup>-4</sup>	J <sub>1</sub> × 10 <sup>-4</sup>
4	22.4	22.66	61.8	579.2	> 3.5	MRO-MRV 63	16460	156.5	127.5	130.00	24.2220
		25.0	26.10	53.6	672.0	1.3	MRO-MRV 43	8690	70.0	41.0	130.00
	28.0	26.97	51.9	688.7	2.4	MRO-MRV 53	8140	105.6	76.6	130.00	27.9078
		25.48	55	652.5	> 3.5	MRO-MRV 63	16820	156.5	127.5	130.00	25.3770
		27.92	50.1	716.3	1.1	MRO-MRV 43	8990	70.0	41.0	130.00	4.4508
	31.5	27.68	50.6	709.1	2.2	MRO-MRV 53	9800	105.6	76.6	130.00	26.4183
		27.45	51	705.0	3.5	MRO-MRV 63	15700	156.5	127.5	130.00	22.6360
		32.52	43.1	827.9	1.1	MRO-MRV 43	9390	70.0	41.0	130.00	4.8644
	35.5	31.69	44.2	809.6	2.1	MRO-MRV 53	8230	105.6	76.6	130.00	27.3913
		31.85	44	817.1	3.5	MRO-MRV 63	11540	156.5	127.5	130.00	25.5240
		34.12	41	877.9	1.9	MRO-MRV 53	8340	105.6	76.6	130.00	25.9891
	40.0	33.83	41.4	867.7	3.1	MRO-MRV 63	13920	156.5	127.5	130.00	21.3370
		41.65	33.6	1062.5	1.6	MRO-MRV 53	8510	105.6	76.6	130.00	25.4059
	45.0	42.78	32.7	1092.6	2.7	MRO-MRV 63	11390	156.5	127.5	130.00	20.2710
		43.14	32.5	1096.8	1.6	MRO-MRV 53	8540	105.6	76.6	130.00	25.6370
	50.0	42.95	32.6	1104.3	2.3	MRO-MRV 63	16450	156.5	127.5	130.00	23.3660
		51.34	27.3	1323.1	1.3	MRO-MRV 53	8720	105.6	76.6	130.00	25.2163
	56.0	50.91	27.5	1304.9	2.6	MRO-MRV 63	9810	156.5	127.5	130.00	18.9780
		56.67	24.7	1441.7	1.2	MRO-MRV 53	8820	105.6	76.6	130.00	25.3529
	63.0	56.19	24.9	1445.2	2.3	MRO-MRV 63	9970	156.5	127.5	130.00	19.4030
		64.91	21.6	1657.1	1.1	MRO-MRV 53	8950	105.6	76.6	130.00	25.0608
	71.0	64.36	21.8	1659.3	2.0	MRO-MRV 63	10200	156.5	127.5	130.00	18.5080
		72.56	19.3	1844.4	0.9	MRO-MRV 53	10800	105.6	76.6	130.00	25.1812
	80.0	73.41	19.1	1884.1	1.7	MRO-MRV 63	11430	156.5	127.5	130.00	18.8420
		84.55	16.6	2167.7	1.6	MRO-MRV 63	11400	156.5	127.5	130.00	18.1240
	90.0	91.04	15.4	2360.0	0.8	MRO-MRV 53	8400	105.6	76.6	130.00	24.8176
		90.27	15.5	2317.2	1.5	MRO-MRV 63	11400	156.5	127.5	130.00	17.8220
	100.0	100.20	14	2542.9	0.7	MRO-MRV 53	8000	105.6	76.6	130.00	24.8837
100.70		13.9	2584.6	1.3	MRO-MRV 63	9800	156.5	127.5	130.00	17.9540	
112.0	118.58	11.8	3054.5	1.1	MRO-MRV 63	9800	156.5	127.5	130.00	17.6270	
125.0	128.72	10.9	3320.0	0.8	MRO-MRV 63	22060	156.5	127.5	130.00	17.7600	
140.0	141.23	9.9	3632.4	0.9	MRO-MRV 63	9800	156.5	127.5	130.00	17.5400	
160.0	154.91	9.04	3952.9	0.9	MRO-MRV 63	9800	156.5	127.5	130.00	17.5010	
5.5	6.3	6.48	215.9	228.3	> 3.5	MRO-MRV 53	8020	119.6	76.6	240.00	46.0154
		6.43	217.7	226.6	> 3.5	MRO-MRV 63	10740	170.5	127.5	240.00	78.1860
	8.0	8.57	163.3	302.5	> 3.5	MRO-MRV 53	8770	119.6	76.6	240.00	38.9230
		8.50	164.7	300.0	> 3.5	MRO-MRV 63	11850	170.5	127.5	240.00	60.6320
	10.0	10.87	128.8	384.4	3.2	MRO-MRV 53	9470	119.6	76.6	240.00	34.9392
		10.78	129.9	380.2	> 3.5	MRO-MRV 63	12750	170.5	127.5	240.00	48.5070
	12.5	13.17	106.3	463.9	3.0	MRO-MRV 53	10050	119.6	76.6	240.00	32.6124
		13.06	107.2	460.1	> 3.5	MRO-MRV 63	13550	170.5	127.5	240.00	41.5040
	14.0	13.63	102.7	481.3	2.2	MRO-MRV 53	10340	119.6	76.6	240.00	29.4533
		13.51	103.6	477.2	3.4	MRO-MRV 63	14110	170.5	127.5	240.00	30.9420
	16.0	16.24	86.2	573.4	2.6	MRO-MRV 53	10150	119.6	76.6	240.00	30.7169
		16.10	87	567.0	> 3.5	MRO-MRV 63	14450	170.5	127.5	240.00	35.7680
	18.0	18.02	77.7	636.6	2.0	MRO-MRV 53	11300	119.6	76.6	240.00	27.8473
		17.87	78.4	630.9	3.1	MRO-MRV 63	15380	170.5	127.5	240.00	26.9670
	20.0	20.53	68.2	721.3	2.2	MRO-MRV 53	8650	119.6	76.6	240.00	29.1621
		20.36	68.8	717.3	> 3.5	MRO-MRV 63	14100	170.5	127.5	240.00	31.0610
22.4	22.85	61.3	805.2	1.8	MRO-MRV 53	11180	119.6	76.6	240.00	26.9452	

**MRO/MRV - 1400 rpm**

P <sub>1</sub> [kW]	i <sub>n</sub>	i <sub>r</sub>	n <sub>2</sub> [rpm]	M <sub>2</sub> [Nm]	FS	Tipo - Size - Größe	F <sub>r2</sub> [N]	MRO/V [kg]	FRO/V [kg]	J <sub>m</sub> × 10 <sup>-4</sup>	J <sub>1</sub> × 10 <sup>-4</sup>
5.5	22.4	22.66	61.8	796.4	2.8	MRO-MRV 63	16460	170.5	127.5	240.00	24.2220
	25.0	26.97	51.9	946.9	1.8	MRO-MRV 53	8140	119.6	76.6	240.00	27.9078
		25.48	55	897.2	2.6	MRO-MRV 63	16820	170.5	127.5	240.00	25.3770
	28.0	27.68	50.6	975.0	1.6	MRO-MRV 53	9800	119.6	76.6	240.00	26.4183
		27.45	51	969.4	2.5	MRO-MRV 63	15700	170.5	127.5	240.00	22.6360
	31.5	31.69	44.2	1113.3	1.5	MRO-MRV 53	8230	119.6	76.6	240.00	27.3913
		31.85	44	1123.6	2.5	MRO-MRV 63	11540	170.5	127.5	240.00	25.5240
	35.5	34.12	41	1207.1	1.4	MRO-MRV 53	8340	119.6	76.6	240.00	25.9891
		33.83	41.4	1193.1	2.3	MRO-MRV 63	13920	170.5	127.5	240.00	21.3370
	40.0	41.65	33.6	1460.9	1.2	MRO-MRV 53	8510	119.6	76.6	240.00	25.4059
		42.78	32.7	1502.3	2.0	MRO-MRV 63	11390	170.5	127.5	240.00	20.2710
	45.0	43.14	32.5	1508.1	1.1	MRO-MRV 53	8540	119.6	76.6	240.00	25.6370
		42.95	32.6	1518.5	1.7	MRO-MRV 63	16450	170.5	127.5	240.00	23.3660
	50.0	50.91	27.5	1794.2	1.9	MRO-MRV 63	9810	170.5	127.5	240.00	18.9780
	56.0	56.19	24.9	1987.1	1.7	MRO-MRV 63	9970	170.5	127.5	240.00	19.4030
	63.0	64.36	21.8	2281.5	1.5	MRO-MRV 63	10200	170.5	127.5	240.00	18.5080
	71.0	73.41	19.1	2590.6	1.3	MRO-MRV 63	11430	170.5	127.5	240.00	18.8420
	80.0	84.55	16.6	2980.6	1.1	MRO-MRV 63	11400	170.5	127.5	240.00	18.1240
90.0	90.27	15.5	3186.2	1.1	MRO-MRV 63	11400	170.5	127.5	240.00	17.8220	
7.5	6.3	6.48	215.9	311.4	3.0	MRO-MRV 53	8020	128.6	76.6	330.00	46.0154
		6.43	217.7	308.9	> 3.5	MRO-MRV 63	10740	179.5	127.5	330.00	78.1860
	8.0	8.57	163.3	412.5	2.7	MRO-MRV 53	8770	128.6	76.6	330.00	38.9230
		8.50	164.7	409.1	> 3.5	MRO-MRV 63	11850	179.5	127.5	330.00	60.6320
	10.0	10.87	128.8	524.1	2.3	MRO-MRV 53	9470	128.6	76.6	330.00	34.9392
		10.78	129.9	518.4	> 3.5	MRO-MRV 63	12750	179.5	127.5	330.00	48.5070
	12.5	13.17	106.3	632.5	2.2	MRO-MRV 53	10050	128.6	76.6	330.00	32.6124
		13.06	107.2	627.4	3.4	MRO-MRV 63	13550	179.5	127.5	330.00	41.5040
	14.0	13.63	102.7	656.3	1.6	MRO-MRV 53	10340	128.6	76.6	330.00	29.4533
		13.51	103.6	650.8	2.5	MRO-MRV 63	14110	179.5	127.5	330.00	30.9420
	16.0	16.24	86.2	781.9	1.9	MRO-MRV 53	10150	128.6	76.6	330.00	30.7169
		16.10	87	773.2	3.0	MRO-MRV 63	14450	179.5	127.5	330.00	35.7680
	18.0	18.02	77.7	868.1	1.4	MRO-MRV 53	11300	128.6	76.6	330.00	27.8473
		17.87	78.4	860.3	2.3	MRO-MRV 63	15380	179.5	127.5	330.00	26.9670
	20.0	20.53	68.2	983.6	1.6	MRO-MRV 53	8650	128.6	76.6	330.00	29.1621
		20.36	68.8	978.1	2.6	MRO-MRV 63	14100	179.5	127.5	330.00	31.0610
	22.4	22.85	61.3	1097.9	1.3	MRO-MRV 53	11180	128.6	76.6	330.00	26.9452
		22.66	61.8	1086.0	2.1	MRO-MRV 63	16460	179.5	127.5	330.00	24.2220
	25.0	26.97	51.9	1291.2	1.3	MRO-MRV 53	8140	128.6	76.6	330.00	27.9078
		25.48	55	1223.4	1.9	MRO-MRV 63	16820	179.5	127.5	330.00	25.3770
	28.0	27.68	50.6	1329.5	1.2	MRO-MRV 53	9800	128.6	76.6	330.00	26.4183
		27.45	51	1321.9	1.9	MRO-MRV 63	15700	179.5	127.5	330.00	22.6360
	31.5	31.69	44.2	1518.1	1.1	MRO-MRV 53	8230	128.6	76.6	330.00	27.3913
		31.85	44	1532.1	1.9	MRO-MRV 63	11540	179.5	127.5	330.00	25.5240
	35.5	34.12	41	1646.1	1.0	MRO-MRV 53	8340	128.6	76.6	330.00	25.9891
		33.83	41.4	1627.0	1.7	MRO-MRV 63	13920	179.5	127.5	330.00	21.3370
	40.0	41.65	33.6	1992.2	0.9	MRO-MRV 53	8510	128.6	76.6	330.00	25.4059
		42.78	32.7	2048.6	1.4	MRO-MRV 63	11390	179.5	127.5	330.00	20.2710
	45.0	43.14	32.5	2056.5	0.8	MRO-MRV 53	8540	128.6	76.6	330.00	25.6370
		42.95	32.6	2070.7	1.2	MRO-MRV 63	16450	179.5	127.5	330.00	23.3660
50.0	50.91	27.5	2446.6	1.4	MRO-MRV 63	9810	179.5	127.5	330.00	18.9780	

**MRO/MRV - 1400 rpm**

P <sub>1</sub> [kW]	i <sub>n</sub>	i <sub>r</sub>	n <sub>2</sub> [rpm]	M <sub>2</sub> [Nm]	FS	Tipo - Size - Größe	F <sub>r2</sub> [N]	MRO/V [kg]	FRO/V [kg]	J <sub>m</sub> × 10 <sup>-4</sup>	J <sub>1</sub> × 10 <sup>-4</sup>
7.5	56.0	56.19	24.9	2709.7	1.2	MRO-MRV 63	9970	179.5	127.5	330.00	19.4030
	63.0	64.36	21.8	3111.1	1.1	MRO-MRV 63	10200	179.5	127.5	330.00	18.5080
	71.0	73.41	19.1	3532.6	0.9	MRO-MRV 63	11430	179.5	127.5	330.00	18.8420
	80.0	84.55	16.6	4064.5	0.8	MRO-MRV 63	11400	179.5	127.5	330.00	18.1240
	90.0	90.27	15.5	4344.8	0.8	MRO-MRV 63	11400	179.5	127.5	330.00	17.8220
11	6.3	6.48	215.9	456.7	2.0	MRO-MRV 53	8020	166.6	76.6	620.00	46.0154
		6.43	217.7	453.1	> 3.5	MRO-MRV 63	10740	217.5	127.5	620.00	78.1860
	8.0	8.57	163.3	605.0	1.8	MRO-MRV 53	8770	166.6	76.6	620.00	38.9230
		8.50	164.7	600.0	2.9	MRO-MRV 63	11850	217.5	127.5	620.00	60.6320
	10.0	10.87	128.8	768.8	1.6	MRO-MRV 53	9470	166.6	76.6	620.00	34.9392
		10.78	129.9	760.4	2.6	MRO-MRV 63	12750	217.5	127.5	620.00	48.5070
	12.5	13.17	106.3	927.7	1.5	MRO-MRV 53	10050	166.6	76.6	620.00	32.6124
		13.06	107.2	920.2	2.3	MRO-MRV 63	13550	217.5	127.5	620.00	41.5040
	14.0	13.63	102.7	962.5	1.1	MRO-MRV 53	10340	166.6	76.6	620.00	29.4533
		13.51	103.6	954.5	1.7	MRO-MRV 63	14110	217.5	127.5	620.00	30.9420
	16.0	16.24	86.2	1146.8	1.3	MRO-MRV 53	10150	166.6	76.6	620.00	30.7169
		16.10	87	1134.1	2.1	MRO-MRV 63	14450	217.5	127.5	620.00	35.7680
	18.0	18.02	77.7	1273.1	1.0	MRO-MRV 53	11300	166.6	76.6	620.00	27.8473
		17.87	78.4	1261.8	1.5	MRO-MRV 63	15380	217.5	127.5	620.00	26.9670
	20.0	20.53	68.2	1442.6	1.1	MRO-MRV 53	8650	166.6	76.6	620.00	29.1621
		20.36	68.8	1434.5	1.8	MRO-MRV 63	14100	217.5	127.5	620.00	31.0610
	22.4	22.66	61.8	1592.9	1.4	MRO-MRV 63	16460	217.5	127.5	620.00	24.2220
25.0	25.48	55	1794.3	1.3	MRO-MRV 63	16820	217.5	127.5	620.00	25.3770	
28.0	27.45	51	1938.8	1.3	MRO-MRV 63	15700	217.5	127.5	620.00	22.6360	
31.5	31.85	44	2247.1	1.3	MRO-MRV 63	11540	217.5	127.5	620.00	25.5240	
35.5	33.83	41.4	2386.3	1.1	MRO-MRV 63	13920	217.5	127.5	620.00	21.3370	
15	6.3	6.48	215.9	622.8	1.5	MRO-MRV 53	8020	176.6	76.6	740.00	46.0154
		6.43	217.7	617.9	2.7	MRO-MRV 63	10740	227.5	127.5	740.00	78.1860
	8.0	8.57	163.3	825.0	1.3	MRO-MRV 53	8770	176.6	76.6	740.00	38.9230
		8.50	164.7	818.2	2.1	MRO-MRV 63	11850	227.5	127.5	740.00	60.6320
	10.0	10.87	128.8	1048.3	1.2	MRO-MRV 53	9470	176.6	76.6	740.00	34.9392
		10.78	129.9	1036.8	1.9	MRO-MRV 63	12750	227.5	127.5	740.00	48.5070
	12.5	13.17	106.3	1265.1	1.1	MRO-MRV 53	10050	176.6	76.6	740.00	32.6124
		13.06	107.2	1254.9	1.7	MRO-MRV 63	13550	227.5	127.5	740.00	41.5040
	14.0	13.63	102.7	1312.5	0.8	MRO-MRV 53	10340	176.6	76.6	740.00	29.4533
		13.51	103.6	1301.6	1.3	MRO-MRV 63	14110	227.5	127.5	740.00	30.9420
	16.0	16.24	86.2	1563.8	0.9	MRO-MRV 53	10150	176.6	76.6	740.00	30.7169
		16.10	87	1546.5	1.5	MRO-MRV 63	14450	227.5	127.5	740.00	35.7680
	18.0	18.02	77.7	1736.1	0.7	MRO-MRV 53	11300	176.6	76.6	740.00	27.8473
		17.87	78.4	1720.6	1.1	MRO-MRV 63	15380	227.5	127.5	740.00	26.9670
	20.0	20.53	68.2	1967.2	0.8	MRO-MRV 53	8650	176.6	76.6	740.00	29.1621
		20.36	68.8	1956.2	1.3	MRO-MRV 63	14100	227.5	127.5	740.00	31.0610
	22.4	22.66	61.8	2172.1	1.0	MRO-MRV 63	16460	227.5	127.5	740.00	24.2220
25.0	25.48	55	2446.8	0.9	MRO-MRV 63	16820	227.5	127.5	740.00	25.3770	
28.0	27.45	51	2643.9	0.9	MRO-MRV 63	15700	227.5	127.5	740.00	22.6360	
31.5	31.85	44	3064.3	0.9	MRO-MRV 63	11540	227.5	127.5	740.00	25.5240	
35.5	33.83	41.4	3254.0	0.8	MRO-MRV 63	13920	227.5	127.5	740.00	21.3370	
18.5	6.3	6.48	215.9	768.1	1.2	MRO-MRV 53	8020	196.6	76.6	1300.00	46.0154
		6.43	217.7	762.0	2.2	MRO-MRV 63	10740	247.5	127.5	1300.00	78.1860
	8.0	8.57	163.3	1017.5	1.1	MRO-MRV 53	8770	196.6	76.6	1300.00	38.9230

### MRO/MRV - 1400 rpm

P <sub>1</sub> [kW]	i <sub>n</sub>	i <sub>r</sub>	n <sub>2</sub> [rpm]	M <sub>2</sub> [Nm]	FS	Tipo - Size - Größe	F <sub>r2</sub> [N]	MRO/V [kg]	FRO/V [kg]	J <sub>m</sub> × 10 <sup>-4</sup>	J <sub>1</sub> × 10 <sup>-4</sup>
18.5	8.0	8.50	164.7	1009.1	1.7	MRO-MRV 63	11850	247.5	127.5	1300.00	60.6320
		10.87	128.8	1292.9	1.0	MRO-MRV 53	9470	196.6	76.6	1300.00	34.9392
	12.5	10.78	129.9	1278.8	1.5	MRO-MRV 63	12750	247.5	127.5	1300.00	48.5070
		13.17	106.3	1560.2	0.9	MRO-MRV 53	10050	196.6	76.6	1300.00	32.6124
	14.0	13.06	107.2	1547.7	1.4	MRO-MRV 63	13550	247.5	127.5	1300.00	41.5040
		13.51	103.6	1605.3	1.0	MRO-MRV 63	14110	247.5	127.5	1300.00	30.9420
	16.0	16.10	87	1907.3	1.2	MRO-MRV 63	14450	247.5	127.5	1300.00	35.7680
	18.0	17.87	78.4	2122.1	0.9	MRO-MRV 63	15380	247.5	127.5	1300.00	26.9670
	20.0	20.36	68.8	2412.6	1.0	MRO-MRV 63	14100	247.5	127.5	1300.00	31.0610
	22.4	22.66	61.8	2678.9	0.8	MRO-MRV 63	16460	247.5	127.5	1300.00	24.2220
22	6.3	6.48	215.9	913.4	1.0	MRO-MRV 53	8020	211.6	76.6	1500.00	46.0154
		6.43	217.7	906.2	1.8	MRO-MRV 63	10740	262.5	127.5	1500.00	78.1860
	8.0	8.57	163.3	1210.0	0.9	MRO-MRV 53	8770	211.6	76.6	1500.00	38.9230
		8.50	164.7	1200.0	1.5	MRO-MRV 63	11850	262.5	127.5	1500.00	60.6320
	10.0	10.87	128.8	1537.5	0.8	MRO-MRV 53	9470	211.6	76.6	1500.00	34.9392
		10.78	129.9	1520.7	1.3	MRO-MRV 63	12750	262.5	127.5	1500.00	48.5070
	12.5	13.17	106.3	1855.4	0.8	MRO-MRV 53	10050	211.6	76.6	1500.00	32.6124
		13.06	107.2	1840.5	1.2	MRO-MRV 63	13550	262.5	127.5	1500.00	41.5040
	14.0	13.51	103.6	1909.0	0.9	MRO-MRV 63	14110	262.5	127.5	1500.00	30.9420
	16.0	16.10	87	2268.1	1.0	MRO-MRV 63	14450	262.5	127.5	1500.00	35.7680
	18.0	17.87	78.4	2523.5	0.8	MRO-MRV 63	15380	262.5	127.5	1500.00	26.9670
	20.0	20.36	68.8	2869.1	0.9	MRO-MRV 63	14100	262.5	127.5	1500.00	31.0610
22.4	22.66	61.8	3185.7	0.7	MRO-MRV 63	16460	262.5	127.5	1500.00	24.2220	

IEC - B5

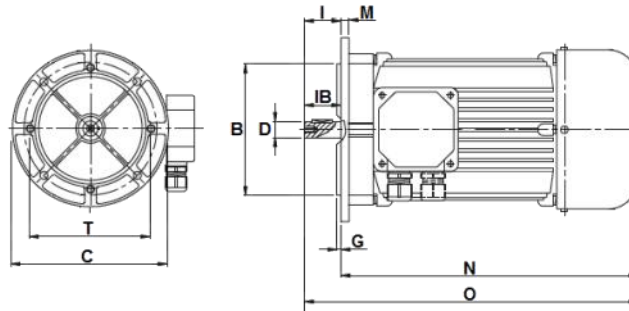

IEC - B14

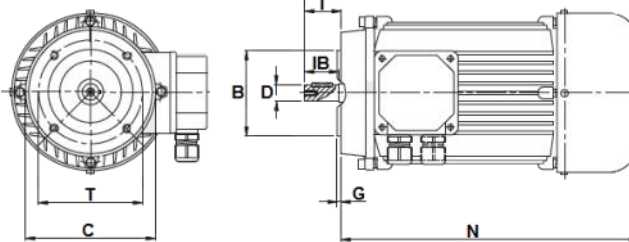

Taglia Size Größe	4 poli - poles - Pole			2 poli - poles - Pole			Flangia - Flange - Flansch C / T / B	Albero Shaft Welle D x I	G	IB	M	N	O
	kW	rpm	kg (B3)	kW	rpm	kg (B3)							
T56A	0.06	1410	2.5	0.09	2730	2.6	B5 - 120 / 100 / 80	9 x 20	2.5	20	8.5	168	188
T56B	0.09	1340	2.6	0.14	2750	3.2	B14 - 80 / 65 / 50					125	145
T63A	0.13	1340	3.7	0.18	2770	3.7	B5 - 140 / 115 / 95	11 x 23	2.5	23	10	190.5	213.5
T63B	0.18	1360	4.3	0.25	2820	4.3	B14 - 90 / 75 / 60					140	161
T71A	0.25	1410	5.8	0.37	2860	5.8	B5 - 160 / 130 / 110	14 x 30	3.0	30	10	218	248
T71B	0.37	1370	6.2	0.55	2860	6.2	B14 - 105 / 85 / 70					168	188
T80A	0.55	1430	8.5	0.75	2860	8.5	B5 - 200 / 165 / 130	19 x 40	3.0	40	11	248	282
T80B	0.75	1430	9.8	1.1	2850	9.8	B14 - 120 / 100 / 80						
T90S	1.1	1430	12.0	1.5	2880	12.0	B5 - 200 / 165 / 130	24 x 50	3.5	50	10	255	305
T90L	1.5	1430	13.5	2.2	2850	13.5	B14 - 140 / 115 / 95					280	330
T100A	2.2	1430	19.0	3	2910	18.5	B5 - 250 / 215 / 180	28 x 60	4.0	60	14	312	372
T100B	3	1430	21.0	4	2920	21.0	B14 - 160 / 130 / 110						
T112A	4	1440	29.0	5.5	2920	32.0	B5 - 250 / 215 / 180 B14 - 160 / 130 / 110	28 x 60	4.0	60	14	330	390
T132S	5.5	1460	43	7.5	2920	48	B5 - 300 / 265 / 230	38 x 80	4.0	80	20	380.5	460.5
T132M	7.5	1460	52	11	2940	54	B14 - 200 / 165 / 130					418.5	498.5
T132ML	9.2	1460	54	15	2940	58							
T160M	11	1470	90	---	---	---	B5 - 350 / 300 / 250	42 x 110	5.0	110	20	491	601
T160L	15	1480	100	18.5	2960	99	B14 - 250 / 215 / 180					535	645
T180M	18.5	1470	120	22	2940	110	B% - 350 / 300 / 250	48 x 110	5.0	110	20	610	720
T180L	22	1480	135	---	---	---							

Dimensioni e pesi non impegnativi

Not binding dimensions and weights

unverbindliche Abmessungen u. Gewichte

### RO13

**MRO  
FRO**

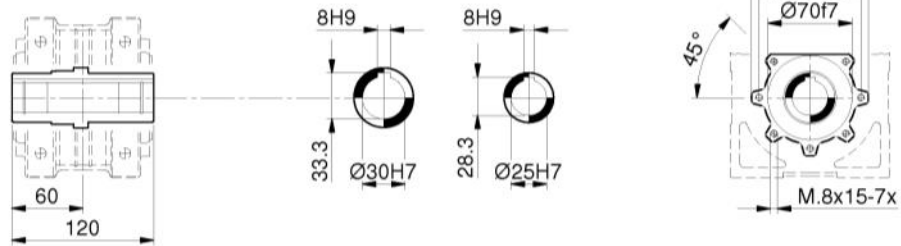
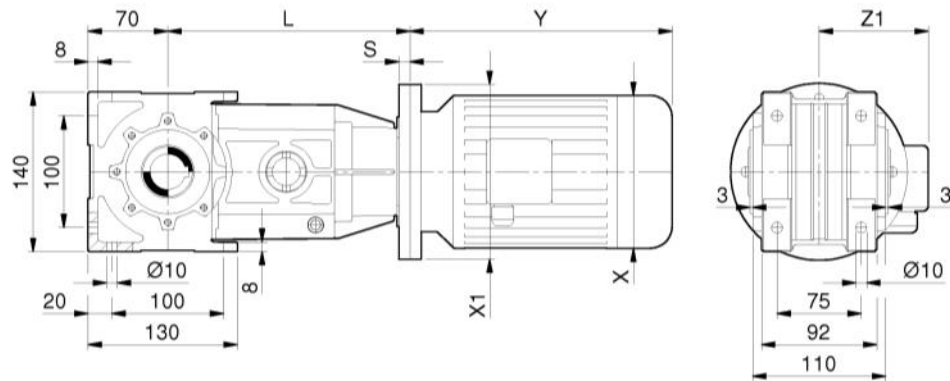

**RO**

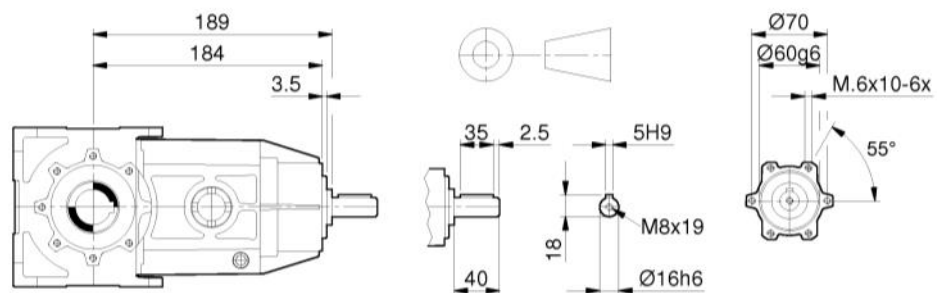

IEC	56	63	71	80	90 S	90 L	
X / Y / Z1	110/168/108	123/185/110	140/220/121	159/238/138	176/255/149	176/280/149	
X1 (B5) / S	120/13	140/13	160/13.5	200/13.5	---	---	
X1 (B14) / S	---	90/13	105/18.5	120/13.5	140/13.5	140/13.5	
L (RO13)	197	197	197.5 (202.5)	197.5	197.5	197.5	

Dimensioni e pesi non impegnativi

Not binding dimensions and weights

unverbindliche Abmessungen u. Gewichte



**RV13**

**MRV  
FRV**

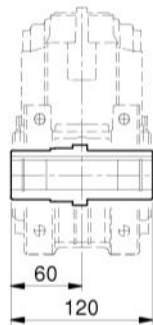
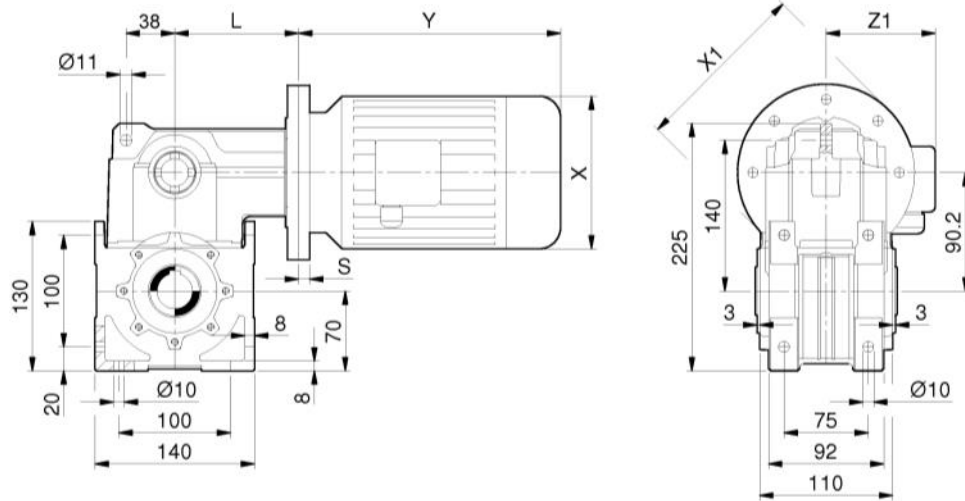

**AC30**

**AC25**

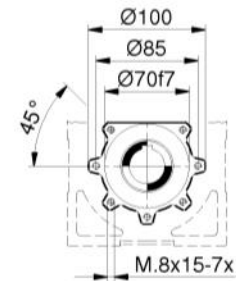

**RV**

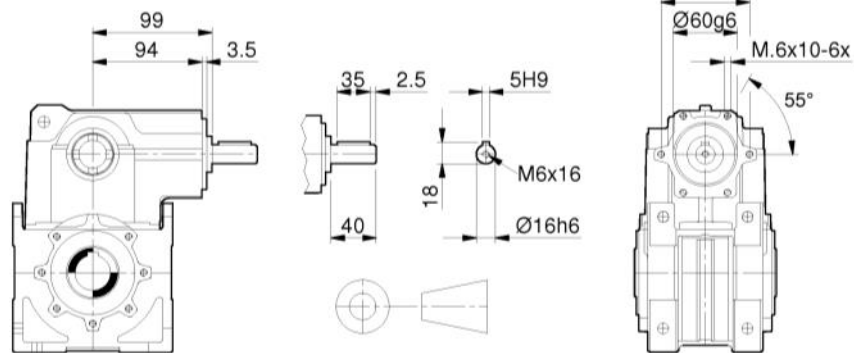

IEC	56	63	71	80	90 S	90 L	
X / Y / Z1	110/168/108	123/185/110	140/220/121	159/238/138	176/255/149	176/280/149	
X1 (B5) / S	120/13	140/13	160/13.5	200/13.5	---	---	
X1 (B14) / S	---	90/13	105/18.5	120/13.5	140/13.5	140/13.5	
L (RV13)	107	107	107.5 (112.5)	107.5	107.5	107.5	

Dimensioni e pesi non impegnativi

Not binding dimensions and weights

unverbindliche Abmessungen u. Gewichte

**RO13-RV13**

**AC**

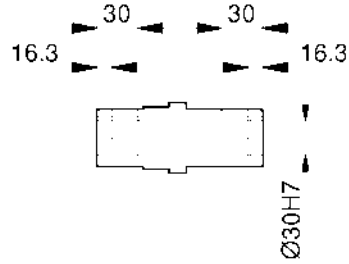
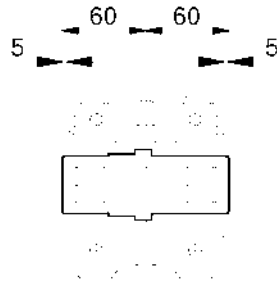

**AS**

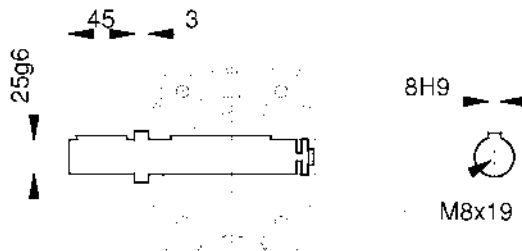

**AD**

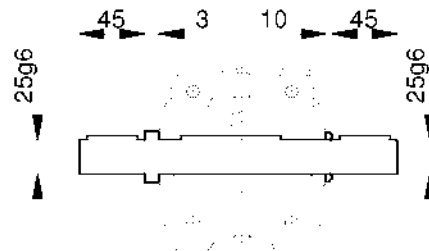

**ACC**

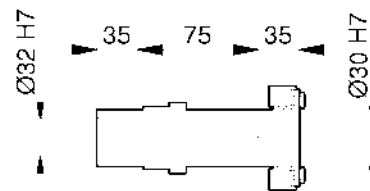
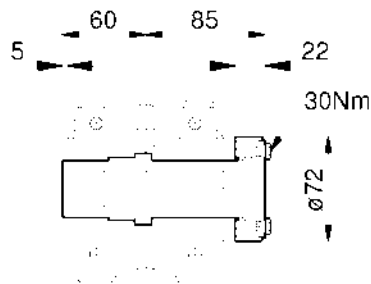

**ACS**

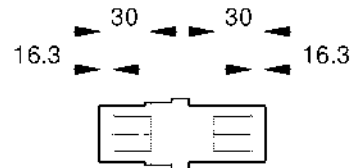
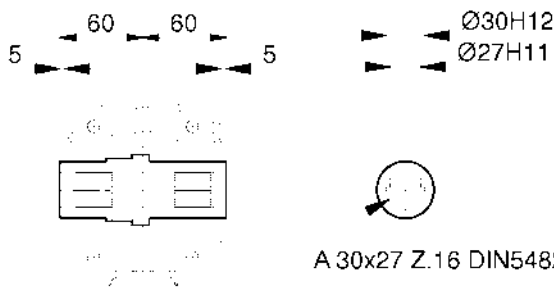

- Dimensioni del perno macchina: pagine  
- Machine shaft dimensions: pages 84-86  
- Maschinenwelle Abmessungen: Seiten

RO13-RV13

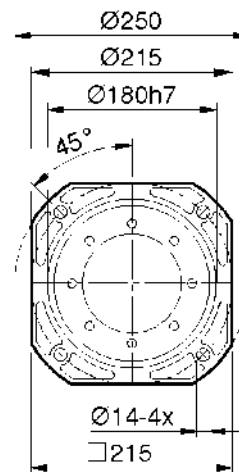
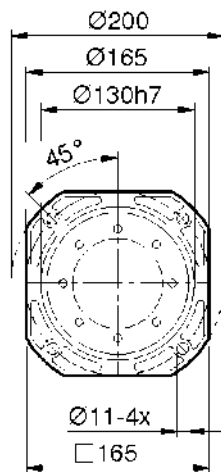
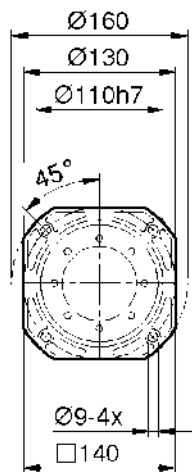
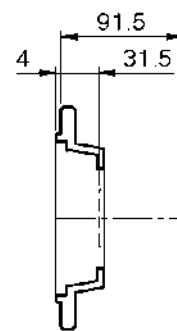
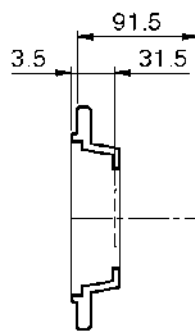
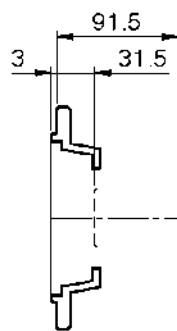
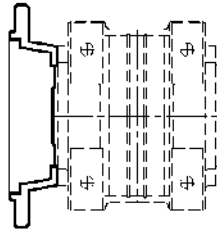

Dimensioni e pesi non impegnativi

Not binding dimensions and weights

unverbindliche Abmessungen u. Gewichte

**RO13-RV13**

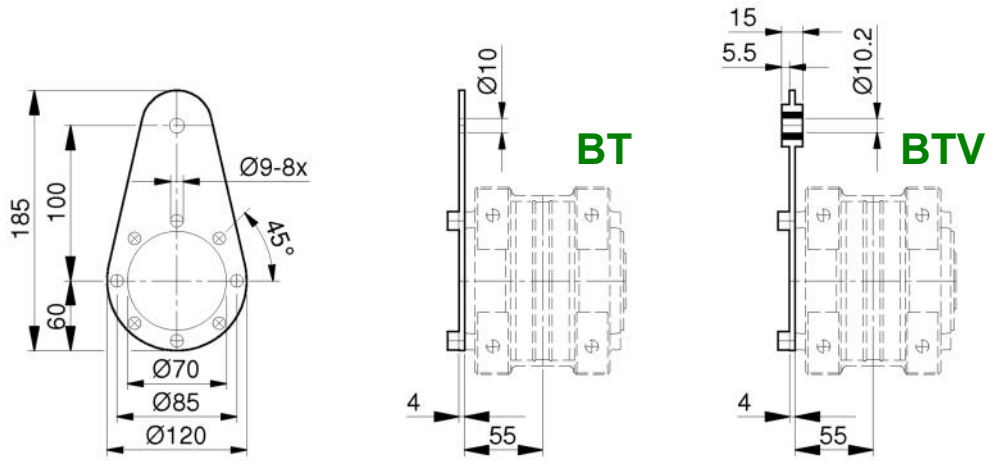

**BTA**

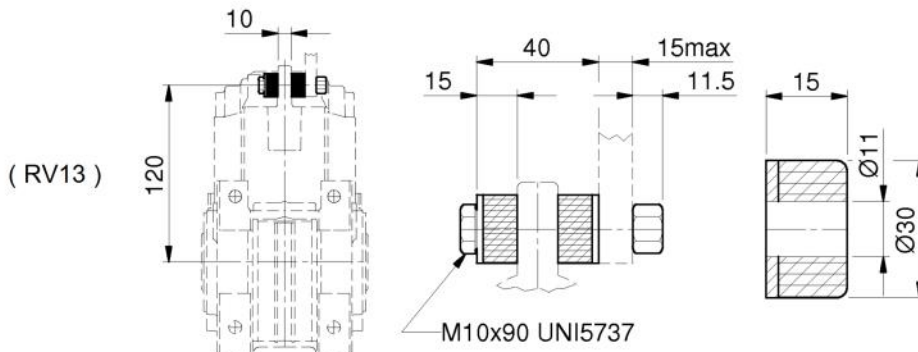

**BTF**

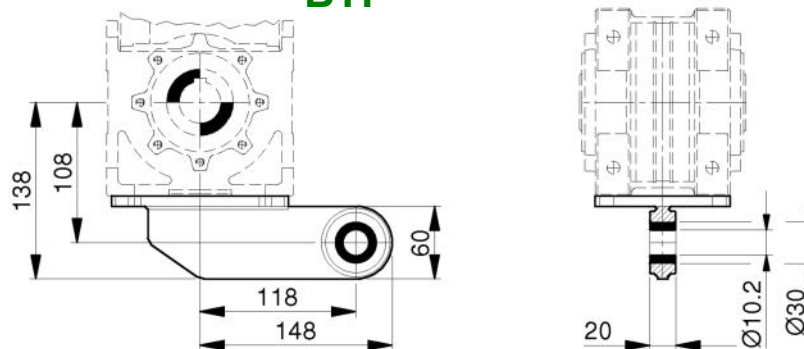

Dimensioni e pesi non impegnativi

Not binding dimensions and weights

unverbindliche Abmessungen u. Gewichte

RO23

MRO  
FRO

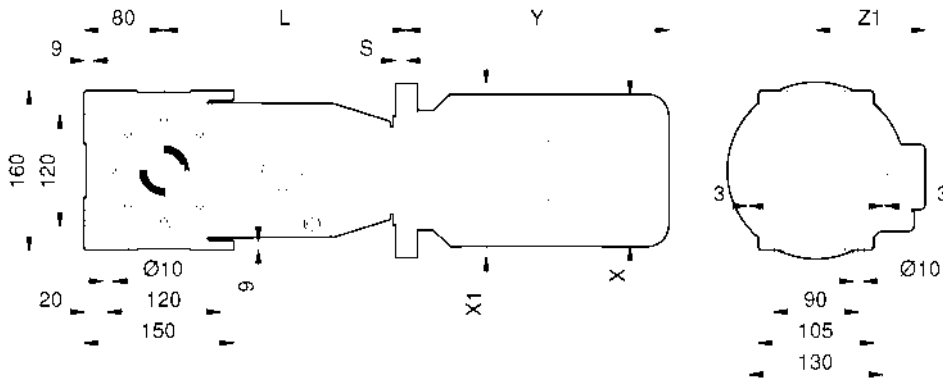

AC35 AC30

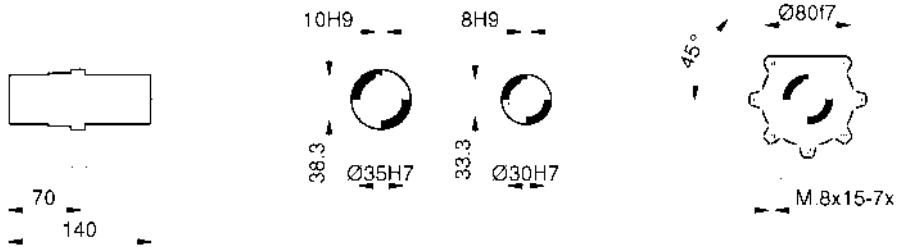

RO

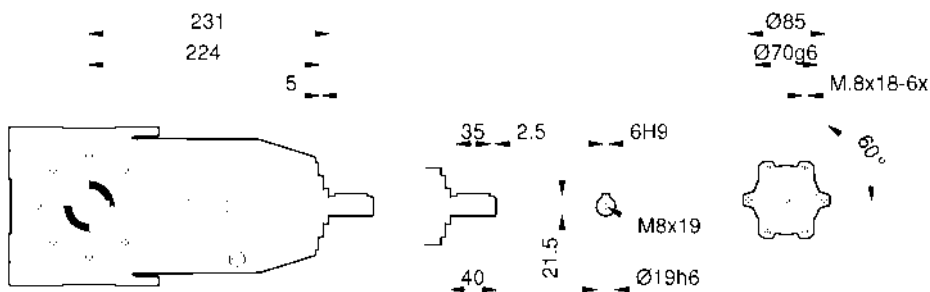

IEC	71	80	90 S	90 L	100	112	
X / Y / Z1	140/220/121	159/238/138	176/255/149	176/280/149	195/314/160	219/328/172	
X1 (B5) / S	160/15.5	200/15.5	200/15.5	200/15.5	250/16.5	250/16.5	
X1 (B14) / S	105/15.5	120/17.5	140/17.5	140/17.5	160/15.5	160/15.5	
L (RO23)	239.5	239.5 (241.5)	239.5 (241.5)	239.5 (241.5)	240.5 (239.5)	240.5 (239.5)	

Dimensioni e pesi non impegnativi

Not binding dimensions and weights

unverbindliche Abmessungen u. Gewichte

**RV23**

**MRV  
FRV**

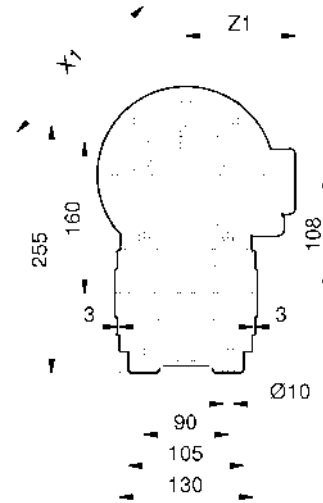
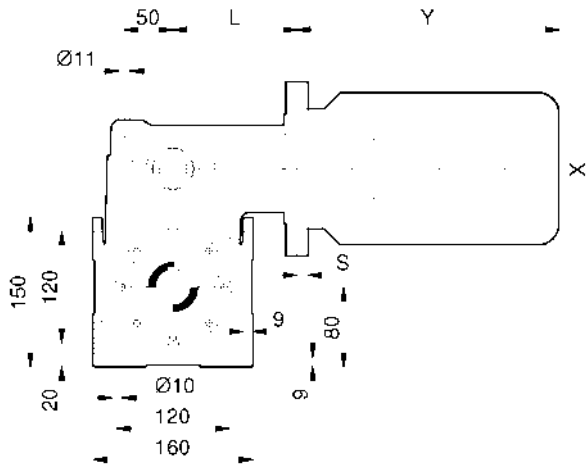

**AC35 AC30**

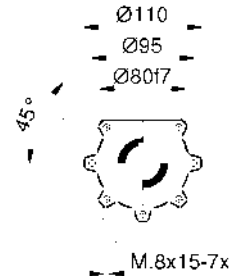
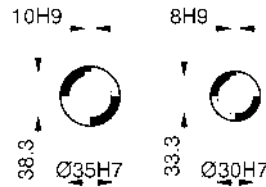

**RV**

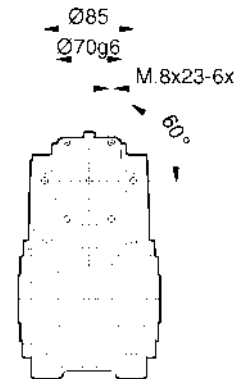
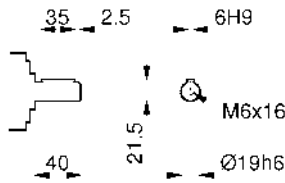
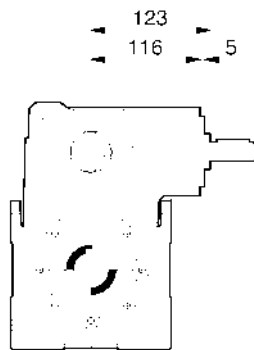

IEC	71	80	90 S	90 L	100	112	
X / Y / Z1	140/220/121	159/238/138	176/255/149	176/280/149	195/314/160	219/328/172	
X1 (B5) / S	160/15.5	200/15.5	200/15.5	200/15.5	250/16.5	250/16.5	
X1 (B14) / S	105/15.5	120/17.5	140/17.5	140/17.5	160/15.5	160/15.5	
L (RV23)	131.5	131.5 (133.5)	131.5 (133.5)	131.5 (133.5)	132.5 (131.5)	132.5 (131.5)	

Dimensioni e pesi non impegnativi

Not binding dimensions and weights

unverbindliche Abmessungen u. Gewichte

RO23-RV23

AC

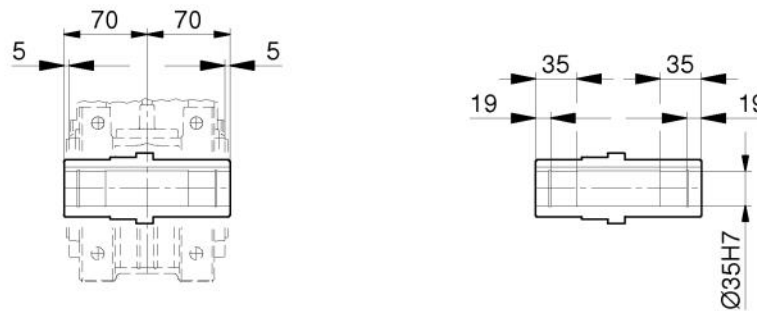

AS

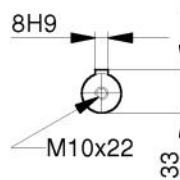
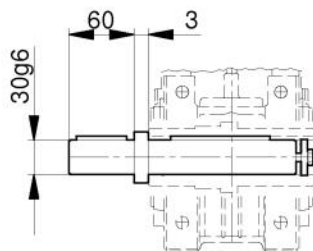

AD

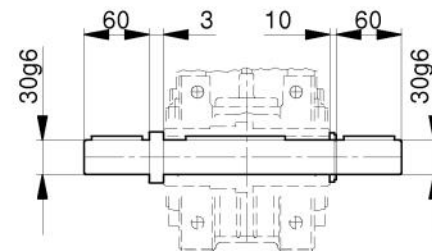

ACC

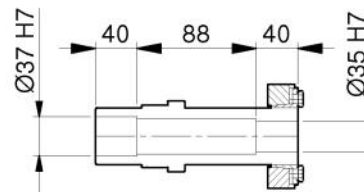
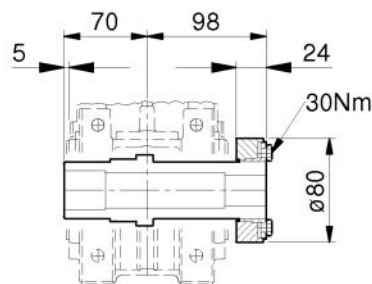

ACS

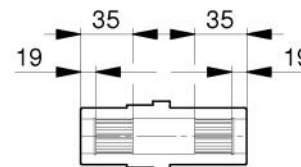
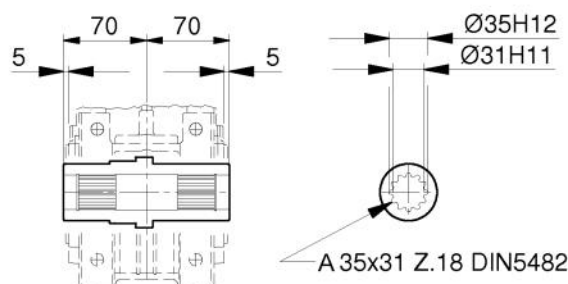

- Dimensioni del perno macchina: pagine
- Machine shaft dimensions: pages 84-86
- Maschinenwelle Abmessungen: Seiten

**RO23-RV23**

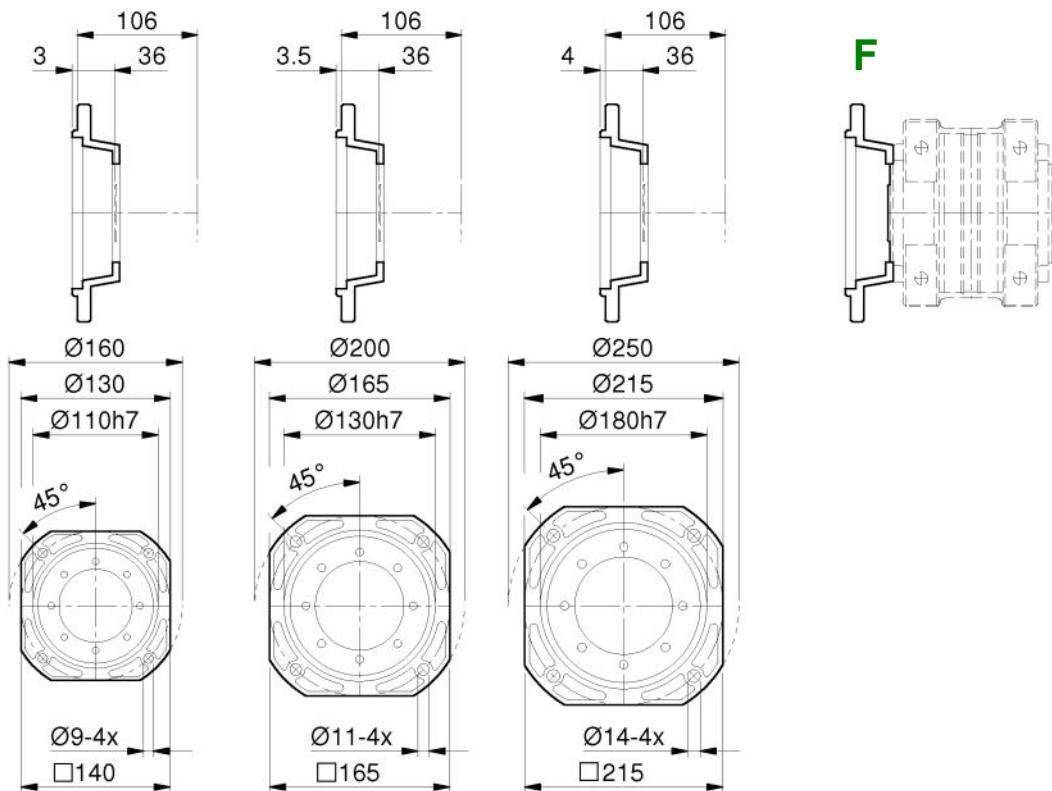
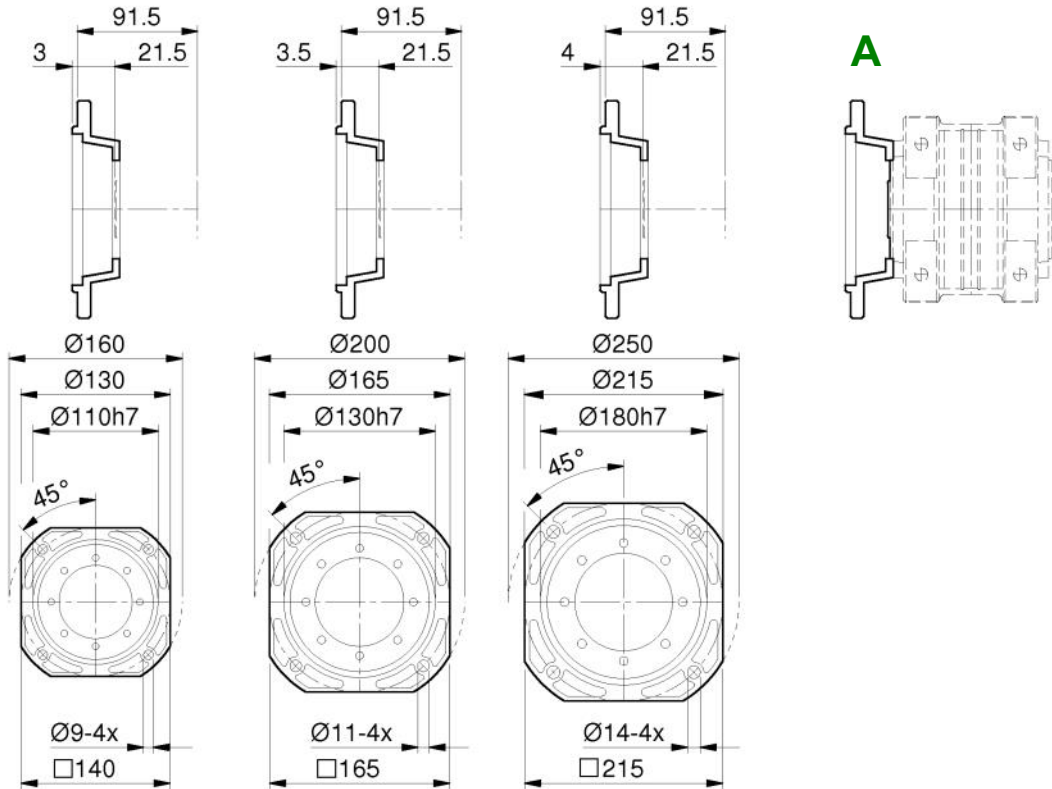

Dimensioni e pesi non impegnativi

Not binding dimensions and weights

unverbindliche Abmessungen u. Gewichte



**RO23-RV23**

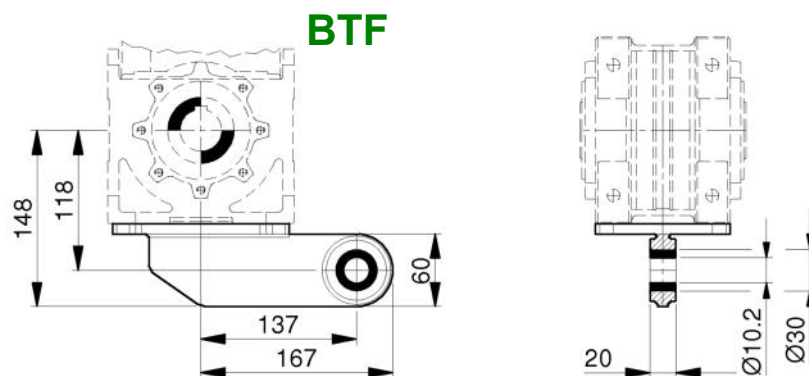
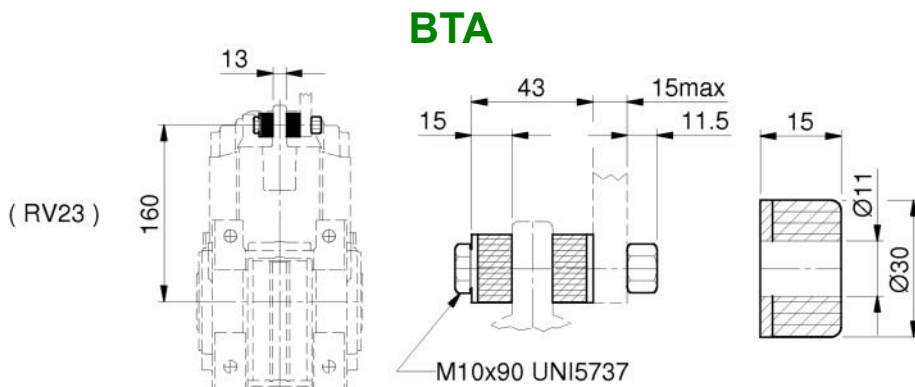
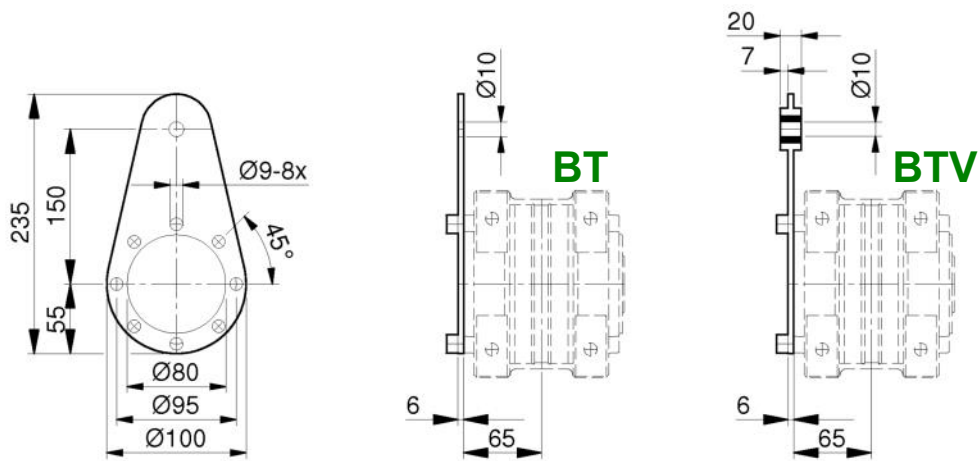

Dimensioni e pesi non impegnativi

Not binding dimensions and weights

unverbindliche Abmessungen u. Gewichte



**RV33**

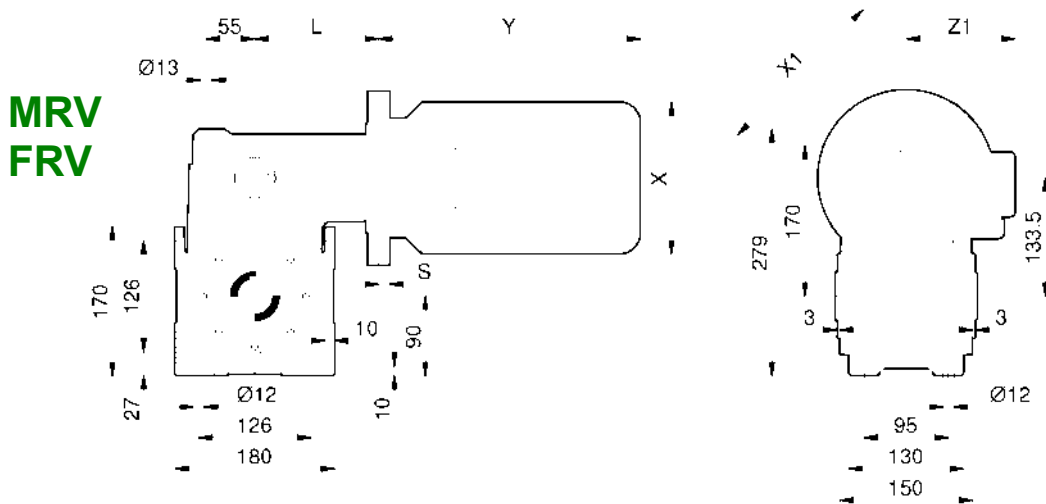

**AC40 AC35**

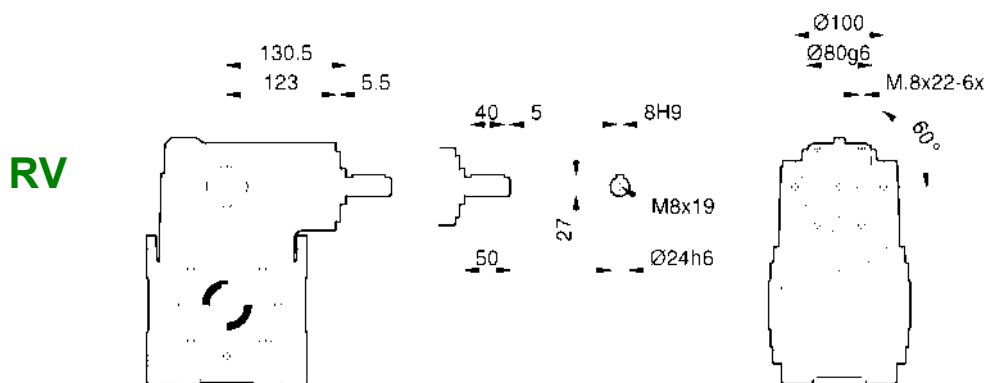
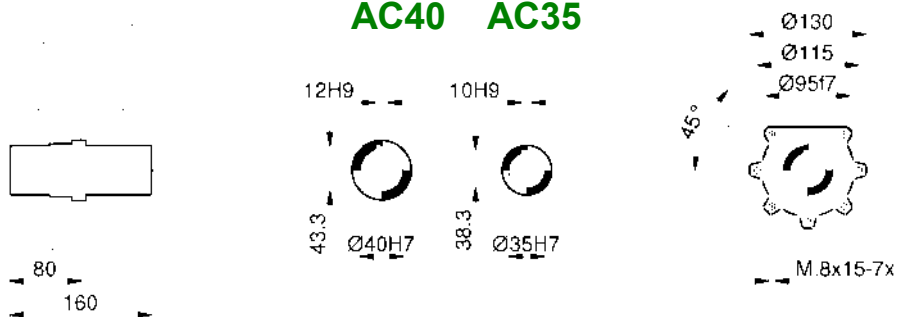

IEC	71	80	90 S	90 L	100	112	
X / Y / Z1	140/220/121	159/238/138	176/255/149	176/280/149	195/314/160	219/328/172	
X1 (B5) / S	160/15.5	200/15.5	200/15.5	200/15.5	250/16.5	250/16.5	
X1 (B14) / S	---	120/15.5	140/17.5	140/17.5	160/15.5	160/15.5	
L (RV33)	138.5	144.5	138.5 (141.5)	138.5 (141.5)	139.5 (138.5)	139.5 (138.5)	

Dimensioni e pesi non impegnativi

Not binding dimensions and weights

unverbindliche Abmessungen u. Gewichte

**RO33-RV33**

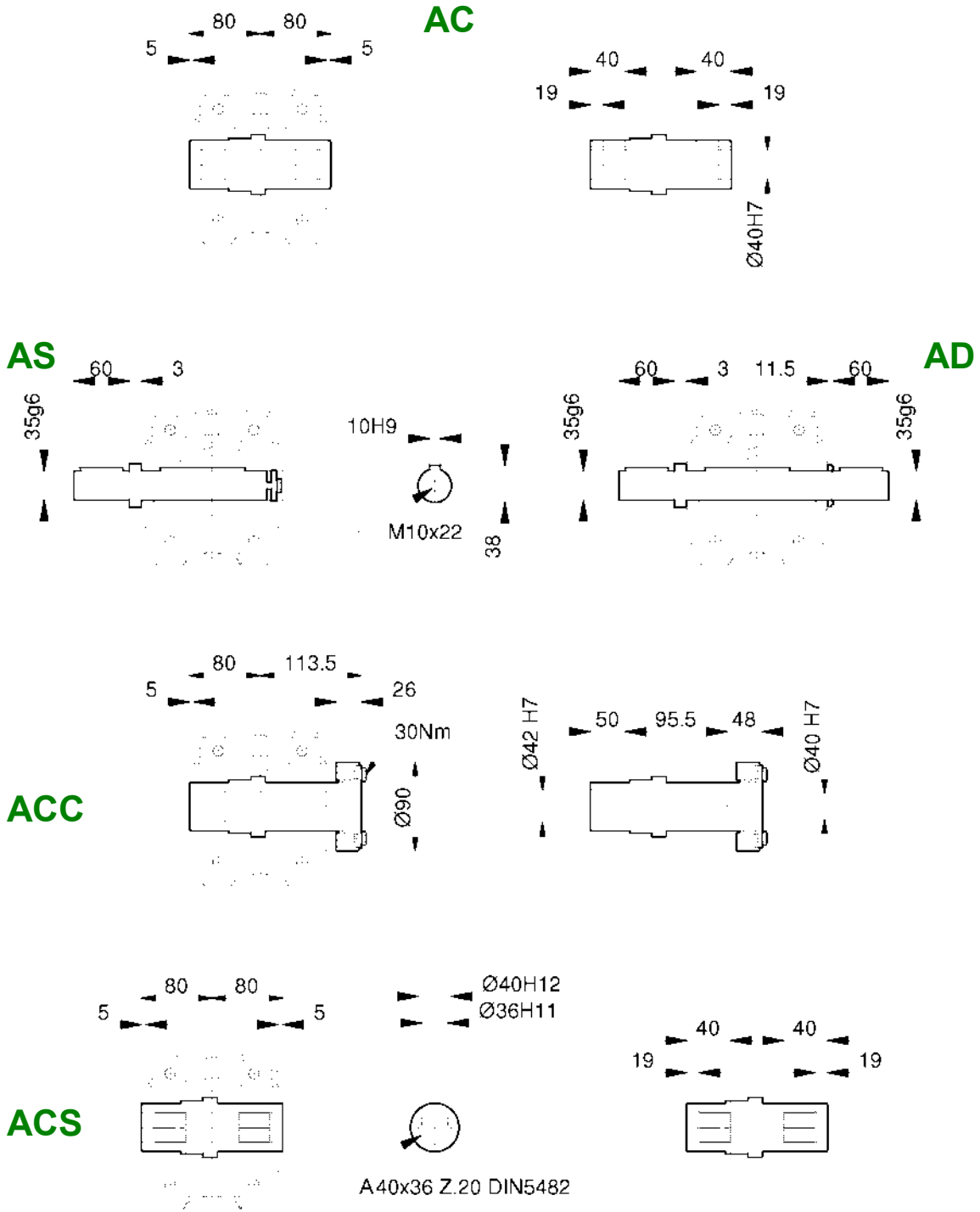

- Dimensioni del perno macchina: pagine  
 - Machine shaft dimensions: pages 84-86  
 - Maschinenwelle Abmessungen: Seiten

**RO33-RV33**

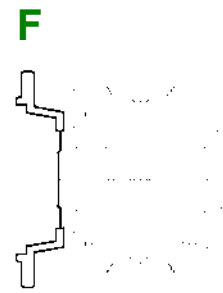
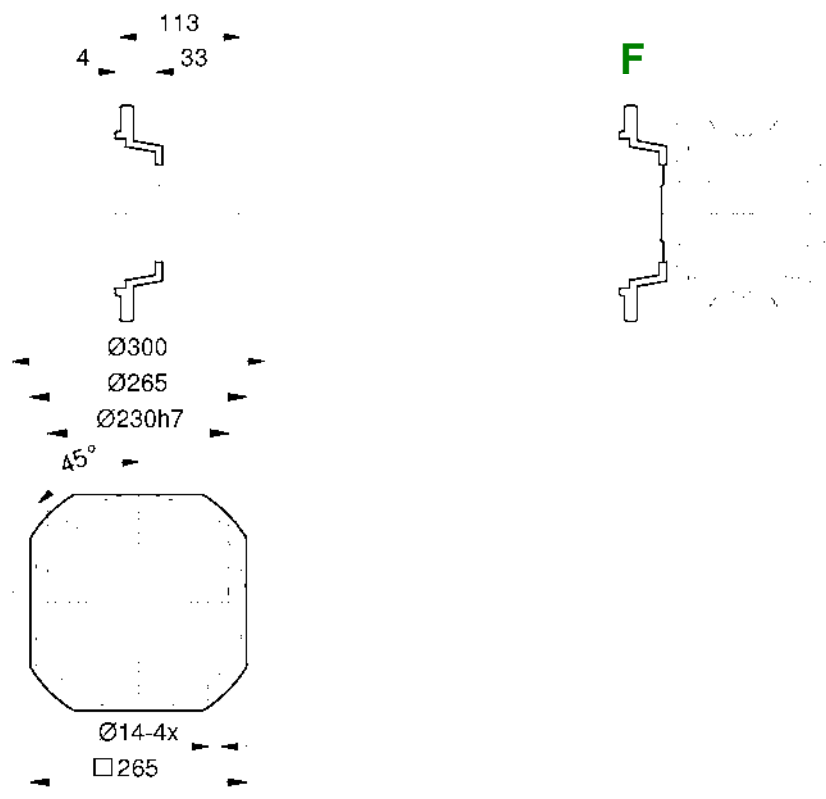
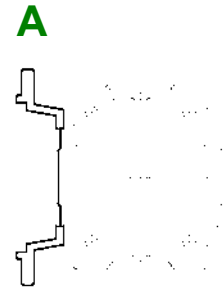
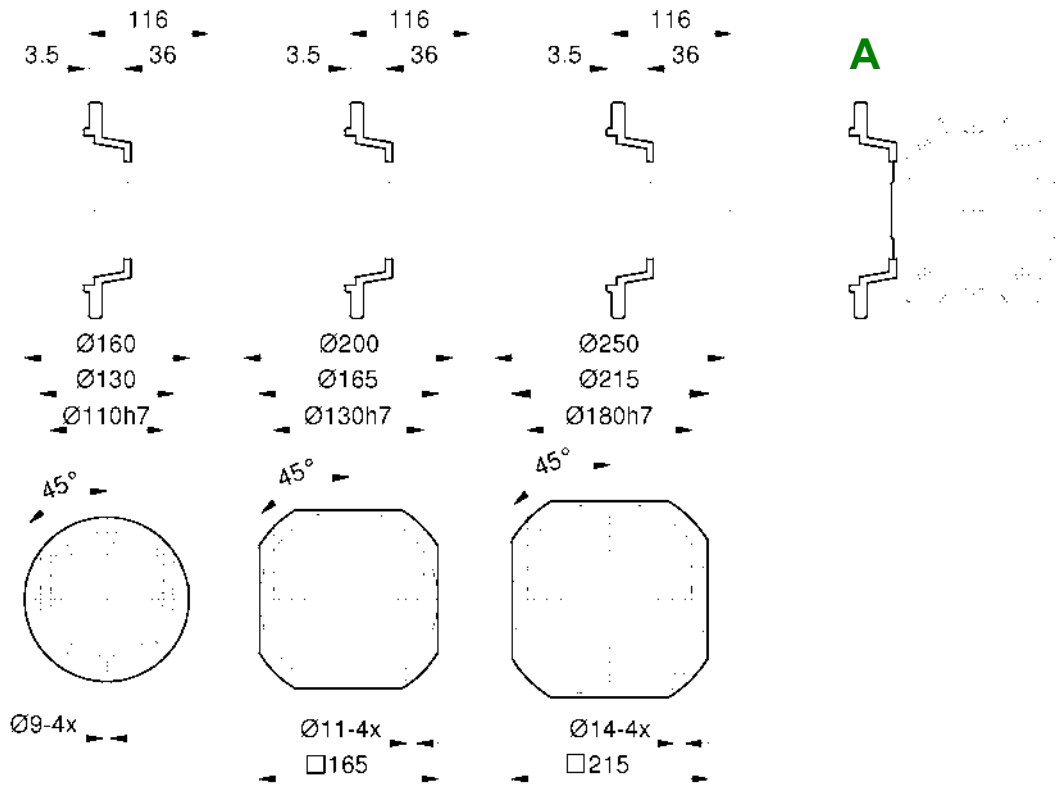

Dimensioni e pesi non impegnativi

Not binding dimensions and weights

unverbindliche Abmessungen u. Gewichte

**RO33-RV33**

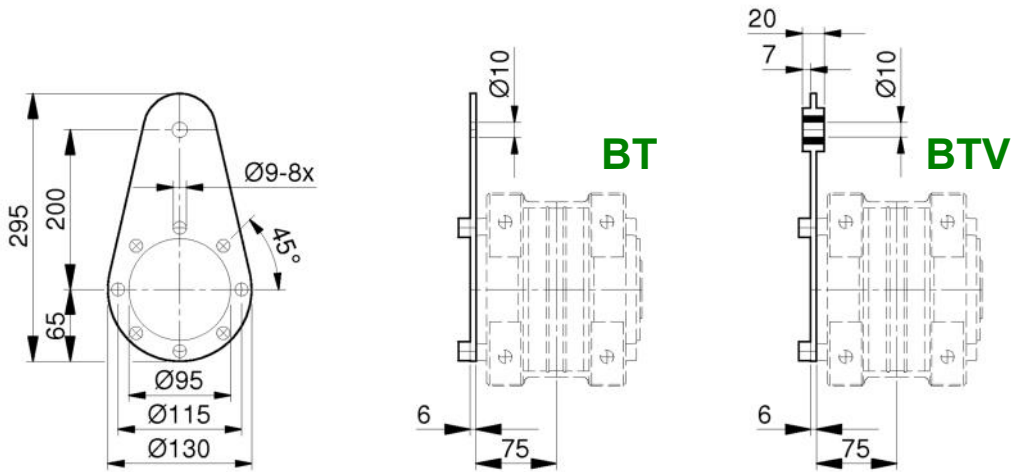

**BTA**

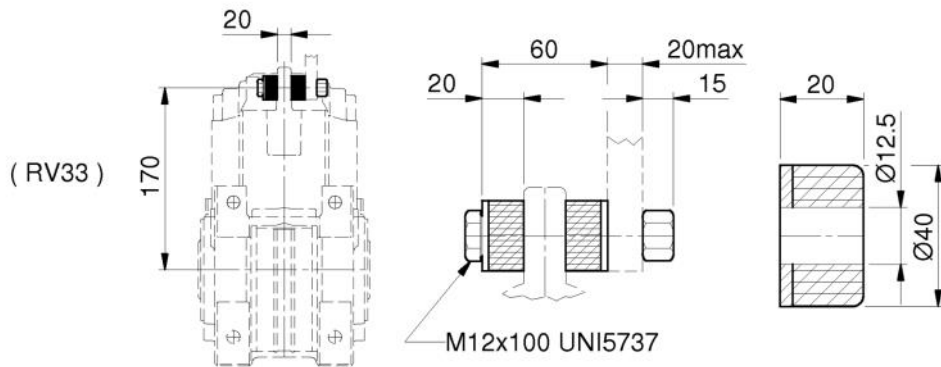

**BTF**

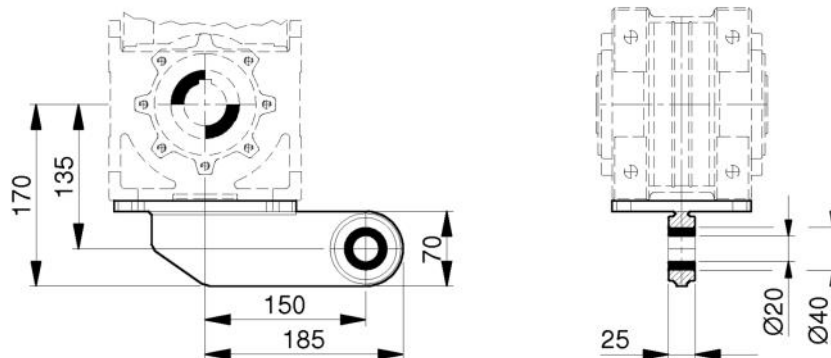

RO43

MRO  
FRO

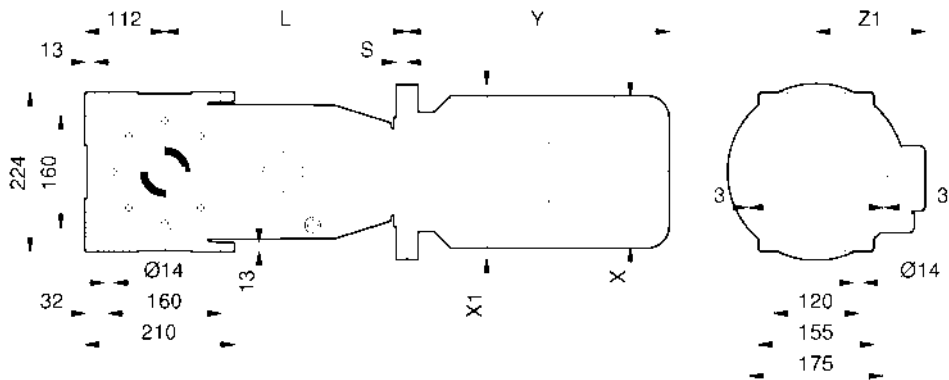

AC50 AC45 AC40

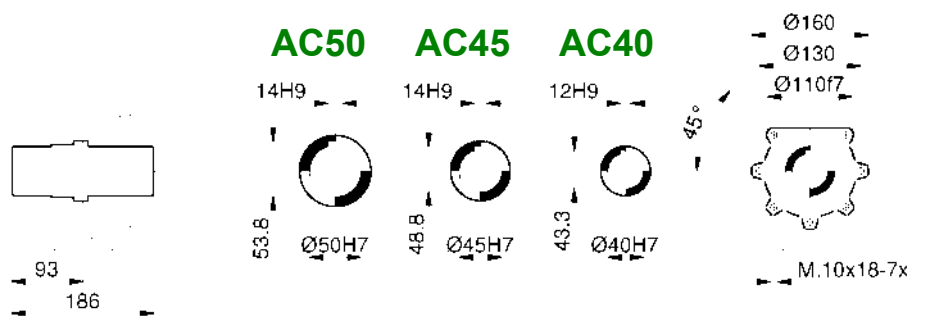

RO

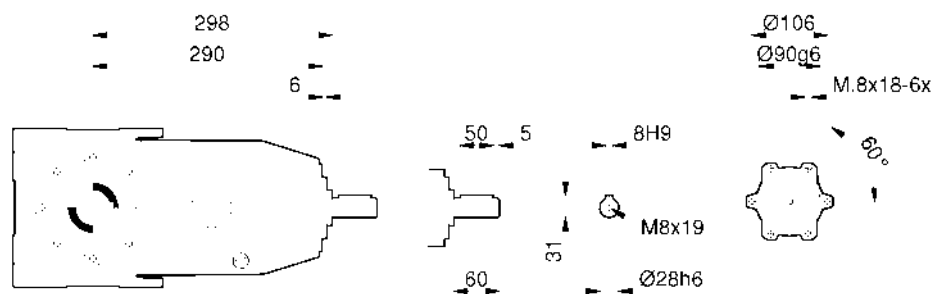

IEC	71	80	90 S	90 L	100	112	
X / Y / Z1	140/220/121	159/238/138	176/255/149	176/280/149	195/314/160	219/328/172	
X1 (B5) / S	160/18	200/18	200/18	200/18	250/18.5	250/18.5	
X1 (B14) / S	---	---	---	---	160/18	160/18	
L (RO43)	308	308	308 (310)	308 (310)	308.5 (308)	308.5 (308)	

Dimensioni e pesi non impegnativi

Not binding dimensions and weights

unverbindliche Abmessungen u. Gewichte

**RO43**

**MRV  
FRV**

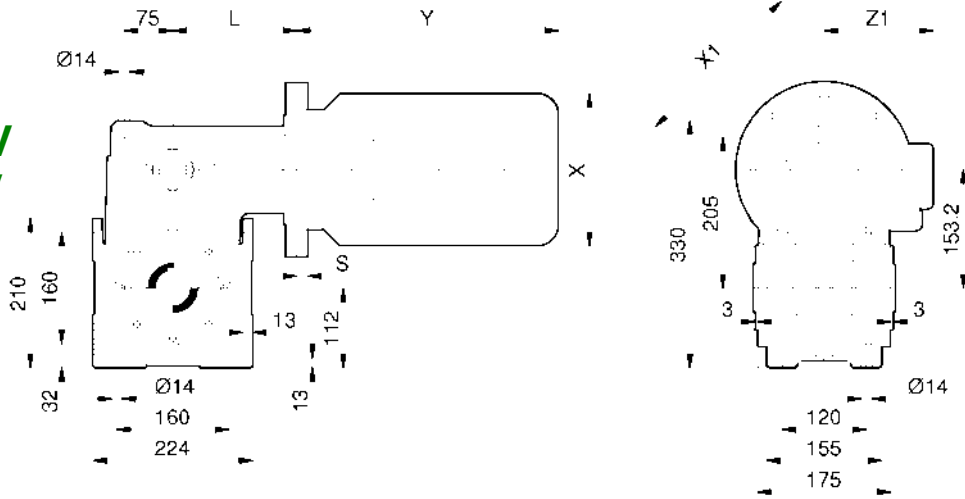

**AC50 AC45 AC40**

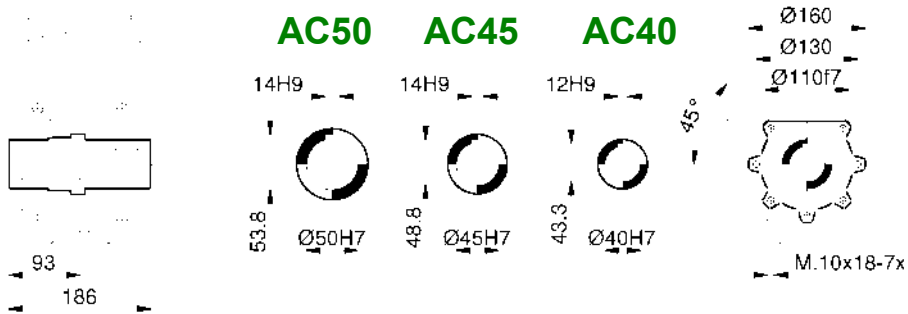

**RV**

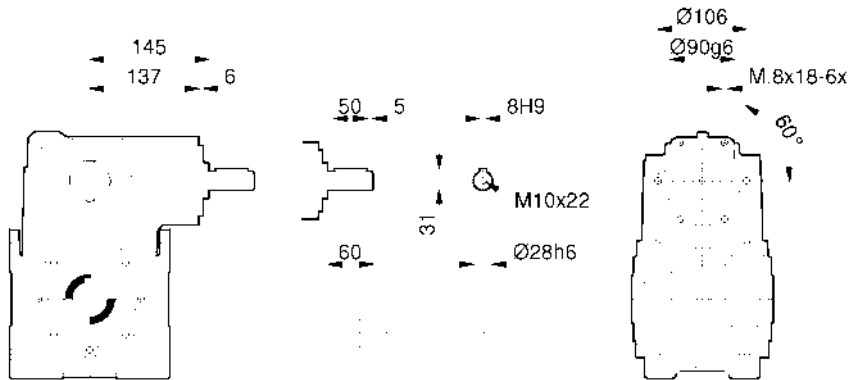

IEC	71	80	90 S	90 L	100	112	
X / Y / Z1	140/220/121	159/238/138	176/255/149	176/280/149	195/314/160	219/328/172	
X1 (B5) / S	160/18	200/18	200/18	200/18	250/18.5	250/18.5	
X1 (B14) / S	---	---	---	---	160/18	160/18	
L (RV43)	155	155	155 (157)	155 (157)	155.5 (155)	155.5 (155)	

Dimensioni e pesi non impegnativi

Not binding dimensions and weights

unverbindliche Abmessungen u. Gewichte



RO43-RV43

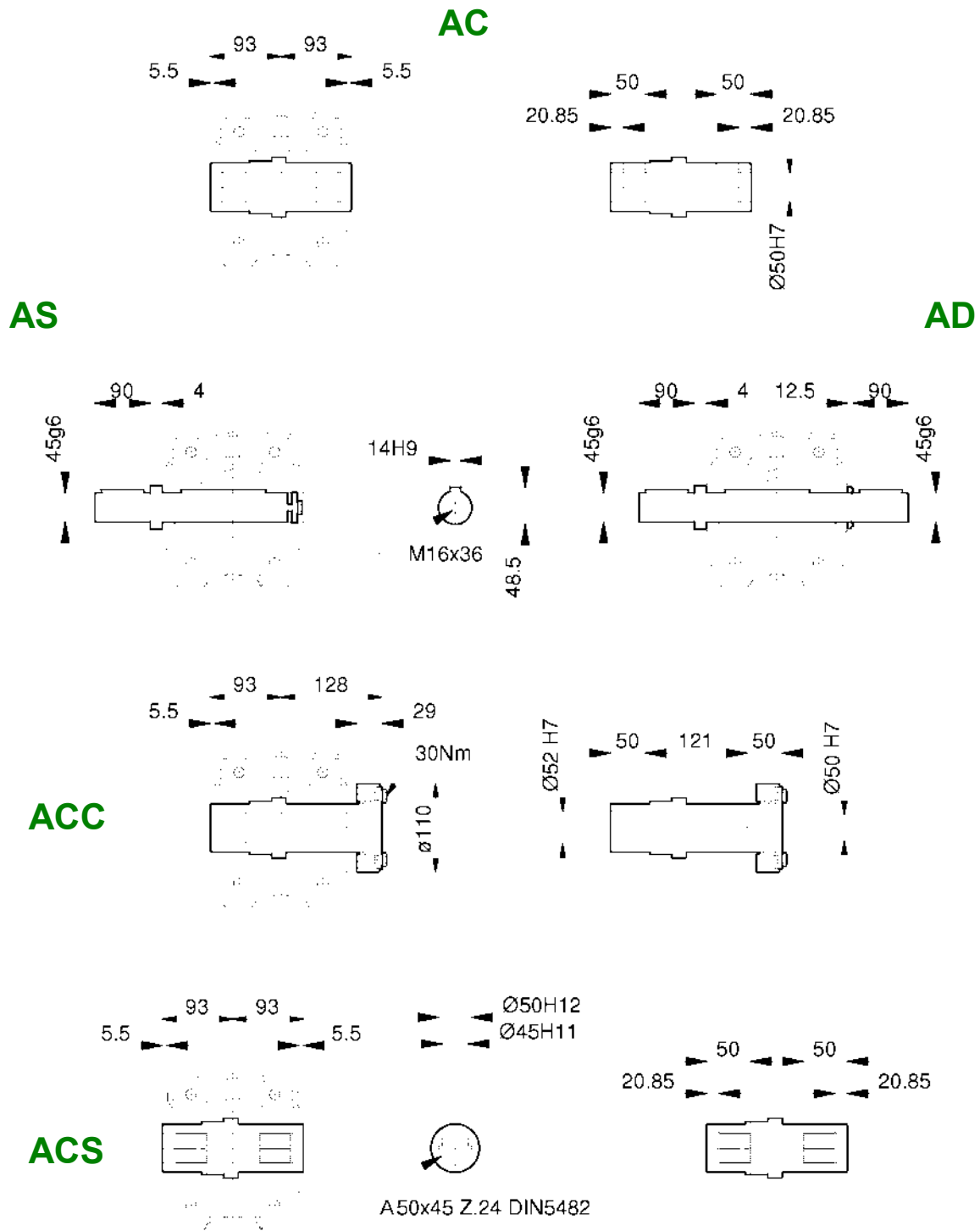

- Dimensioni del perno macchina: pagine  
 - Machine shaft dimensions: pages 84-86  
 - Maschinenwelle Abmessungen: Seiten

**RO43-RV43**

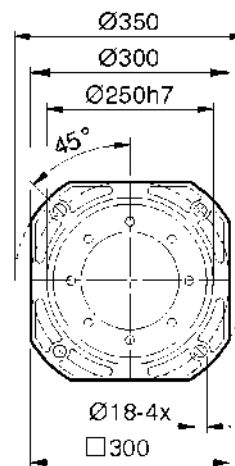
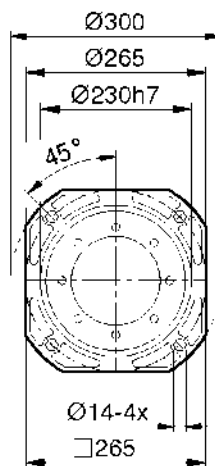
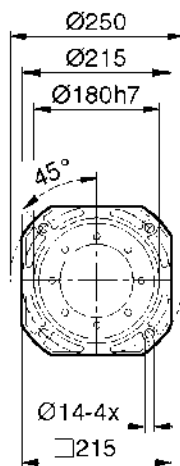
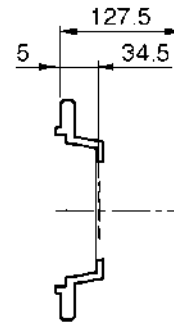
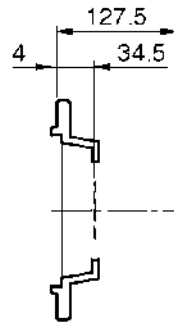
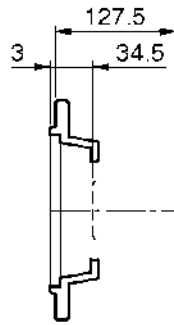
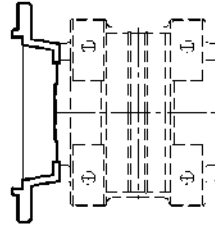

**RO43-RV43**

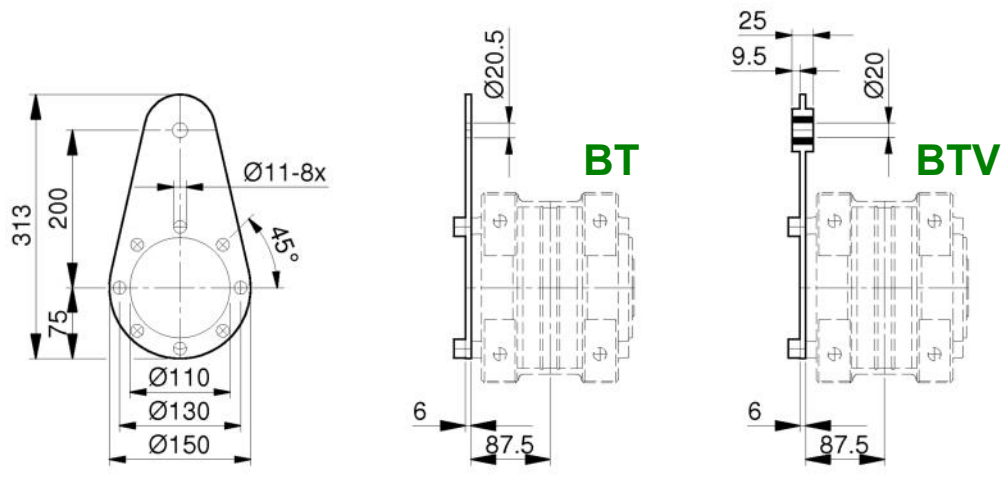

**BTA**

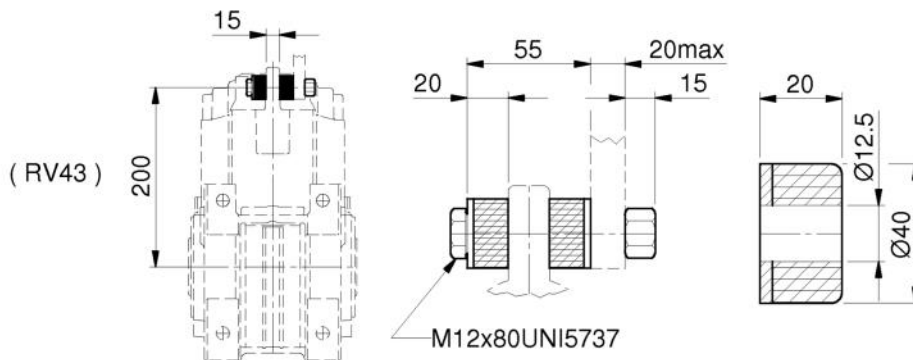

**BTF**

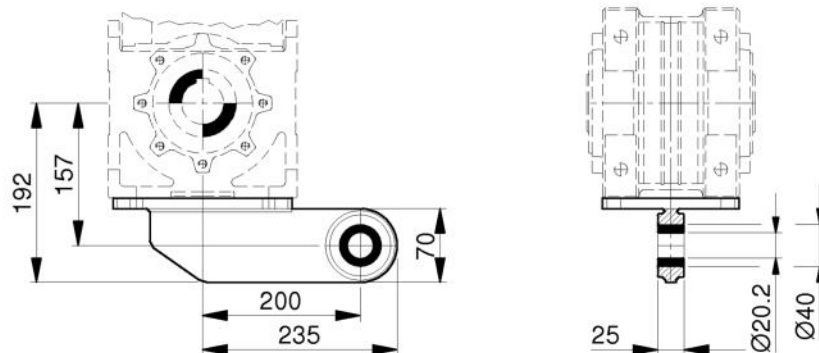

Dimensioni e pesi non impegnativi

Not binding dimensions and weights

unverbindliche Abmessungen u. Gewichte

**RO53**

**MRO  
FRO**

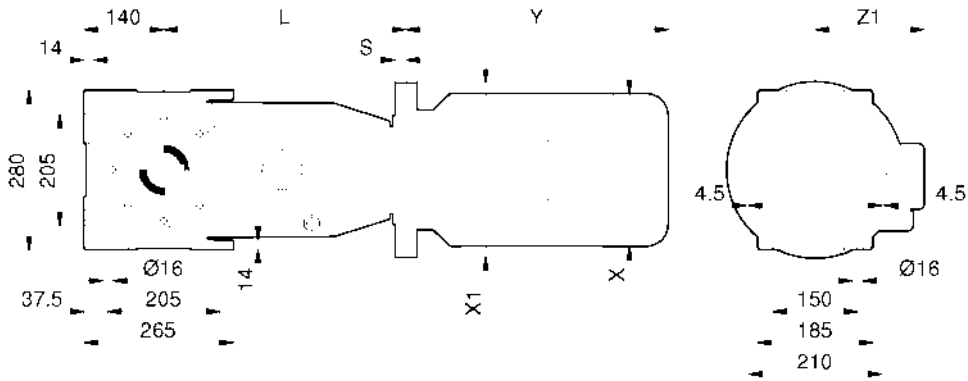

**AC60 AC55 AC50**

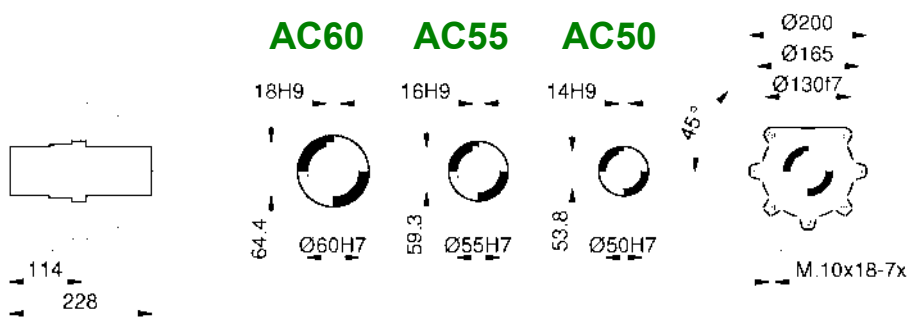

**RO**

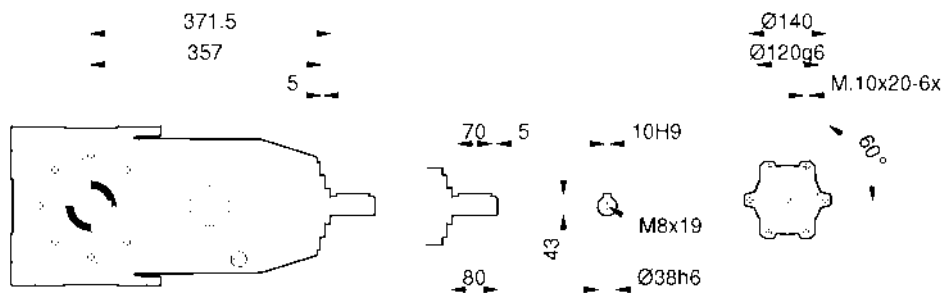

IEC	80	90 S / L	100	112	132 S / M	160	180
X / Y / Z1	159/238/138	176/255-280/149	195/314/160	219/328/172	258/368-410/192	310/486/235	320/580/245
X1 (B5) / S	200/22	200/22	250/22	250/22	300/22	350/35	350/35
X1 (B14) / S	---	---	---	---	200/22	250/22	300/22
L (RO53)	379	379	379	379	379	392 (379)	392 (379)

Dimensioni e pesi non impegnativi

Not binding dimensions and weights

unverbindliche Abmessungen u. Gewichte

**RV53**

**MRV  
FRV**

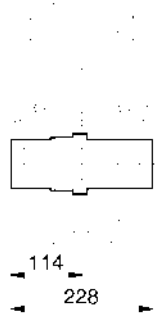
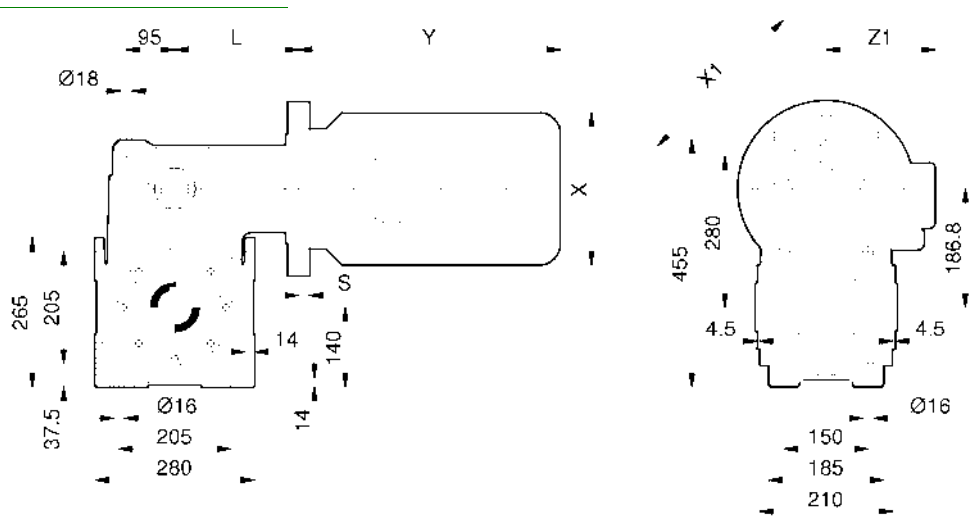

**AC60**



**AC55**



**AC50**

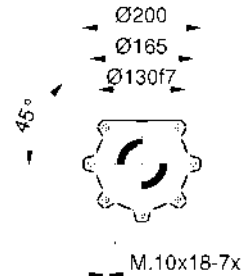
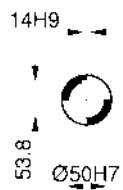

**RV**

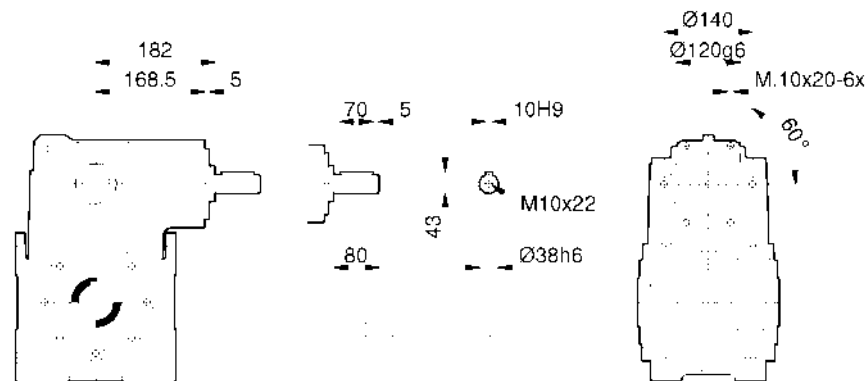

IEC	80	90 S / L	100	112	132 S / M	160	180
X / Y / Z1	159/238/138	176/255-280/149	195/314/160	219/328/172	258/368-410/192	310/486/235	320/580/245
X1 (B5) / S	200/22	200/22	250/22	250/22	300/22	350/35	350/35
X1 (B14) / S	---	---	---	---	200/22	250/22	300/22
L (RV53)	190.5	190.5	190.5	190.5	190.5	203.5 (190.5)	203.5 (190.5)

Dimensioni e pesi non impegnativi

Not binding dimensions and weights

unverbindliche Abmessungen u. Gewichte

**RO53-RV53**

**AC**

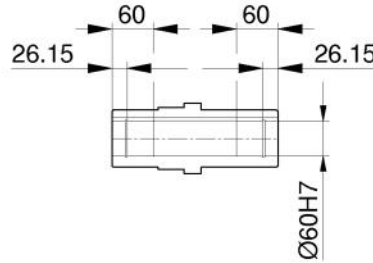
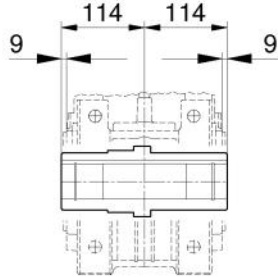

**AS**

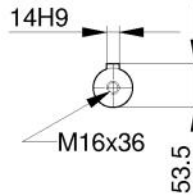
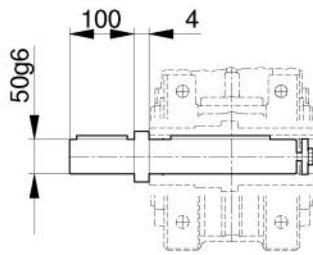

**AD**

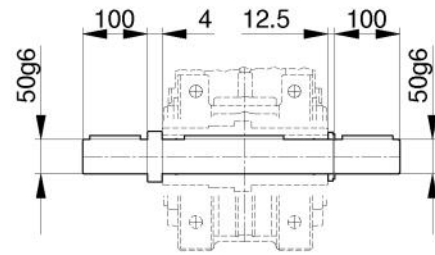

**ACC**

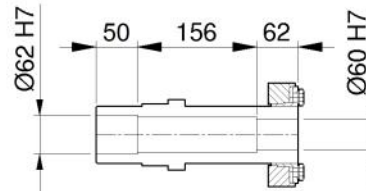
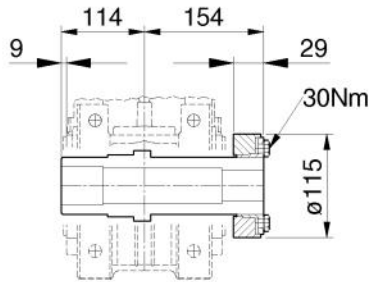

**ACS**

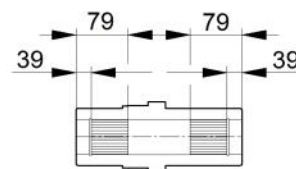
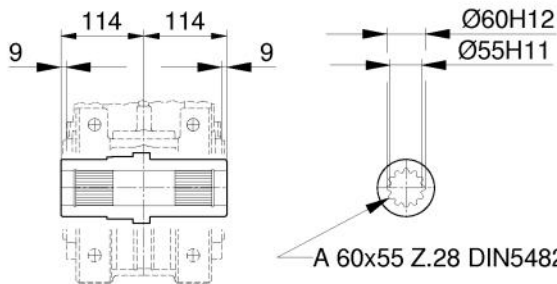

- Dimensioni del perno macchina: pagine 84-86
- Machine shaft dimensions: pages 84-86
- Maschinenwelle Abmessungen: Seiten 84-86

**RO53-RV53**

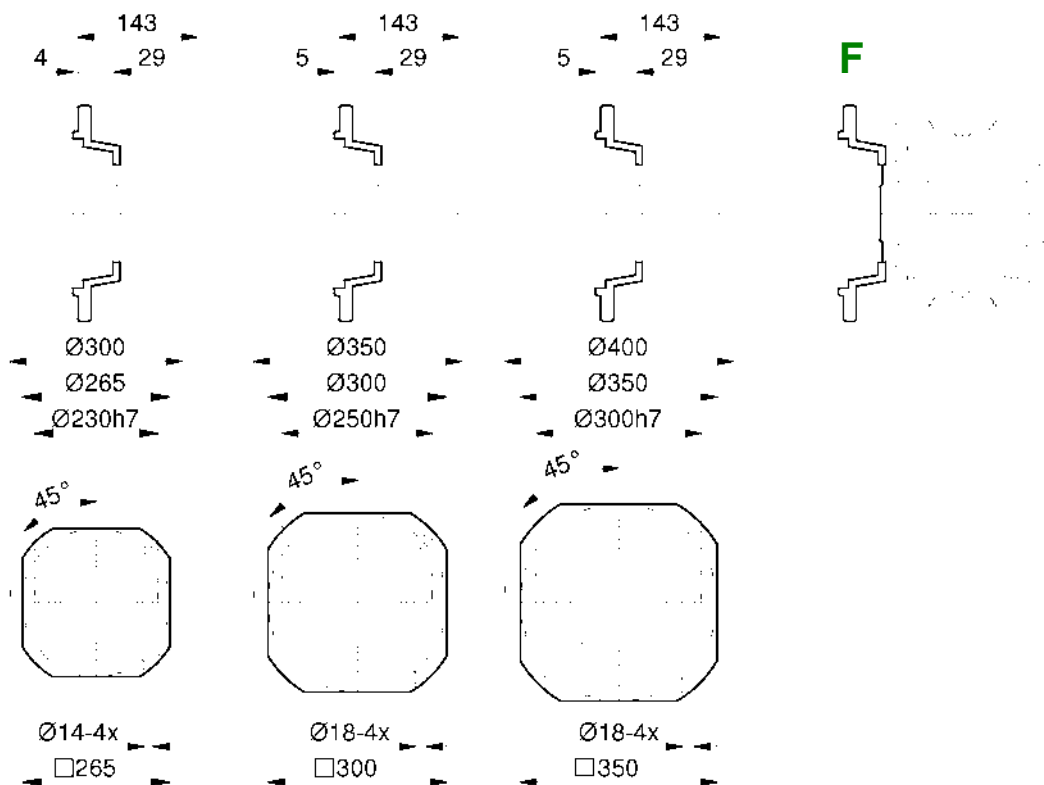
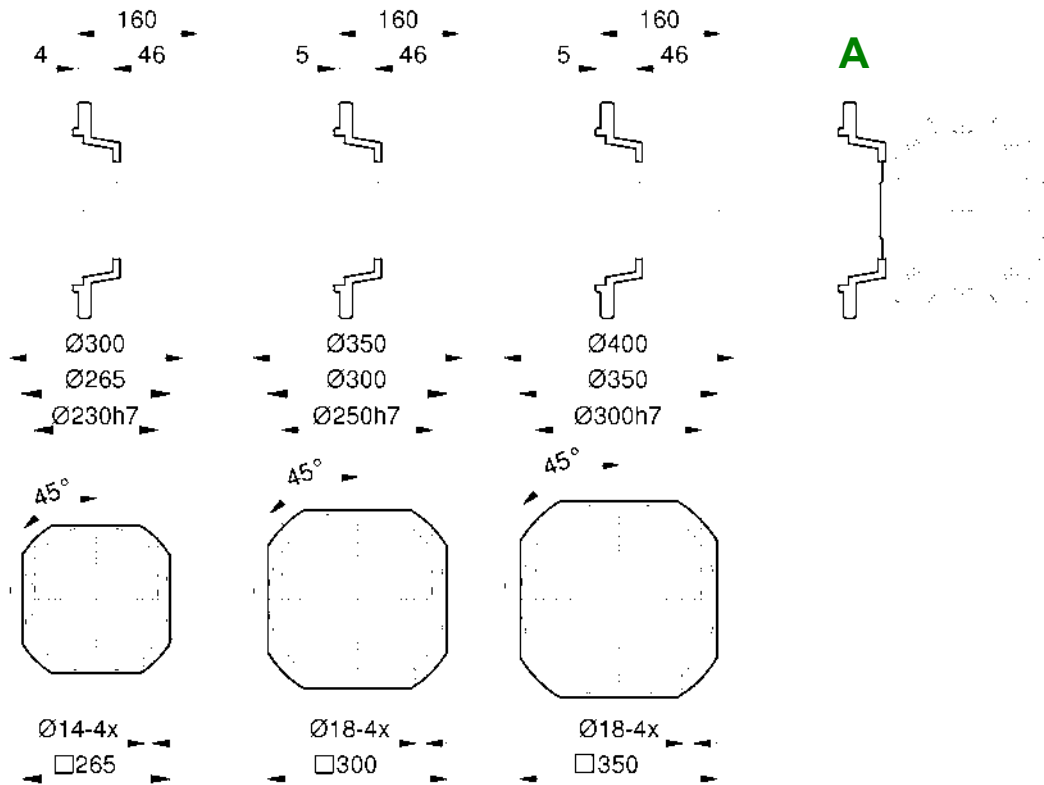

Dimensioni e pesi non impegnativi

Not binding dimensions and weights

unverbindliche Abmessungen u. Gewichte

**RO53-RV53**

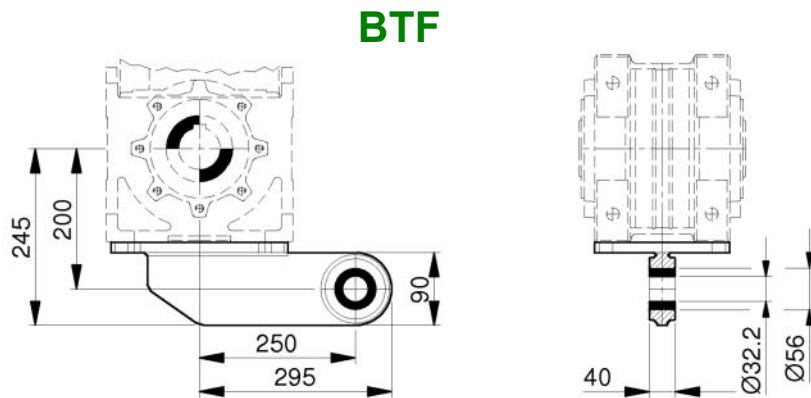
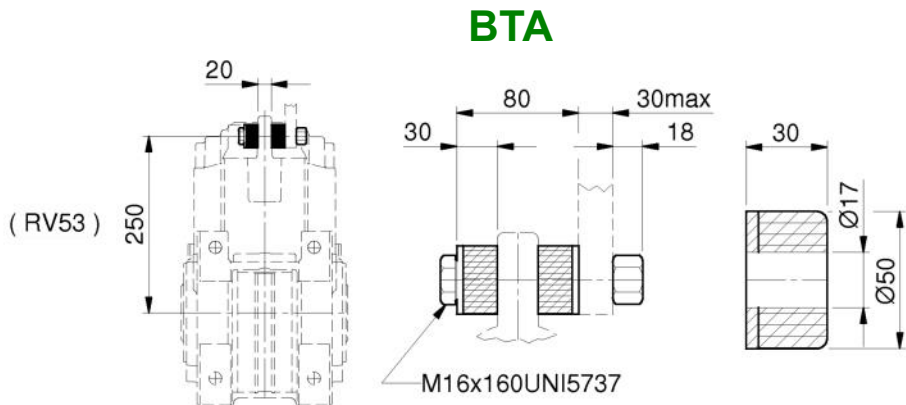
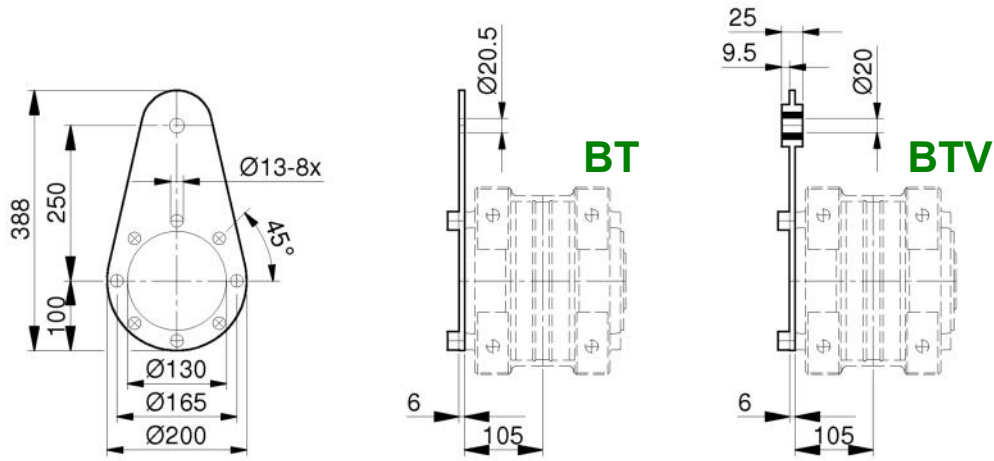

Dimensioni e pesi non impegnativi

Not binding dimensions and weights

unverbindliche Abmessungen u. Gewichte



RO63

MRO  
FRO

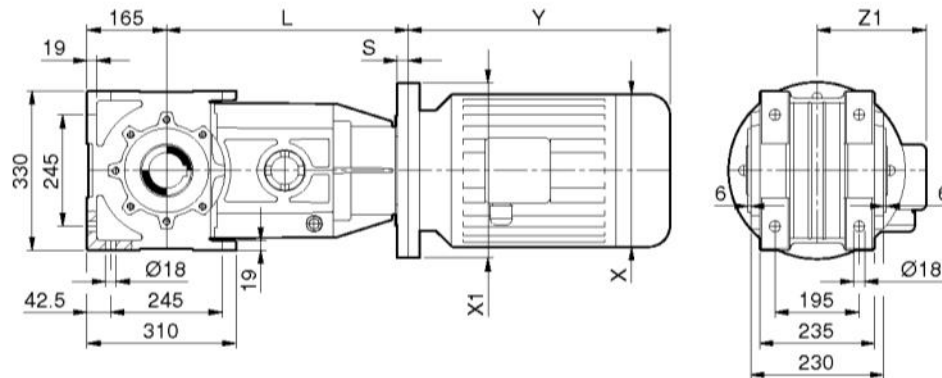

AC70

AC60

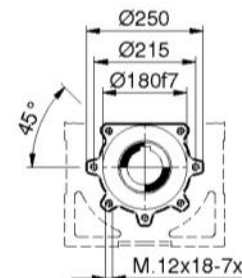
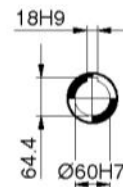
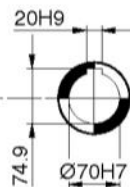
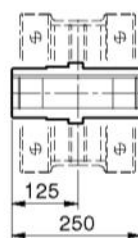

RO

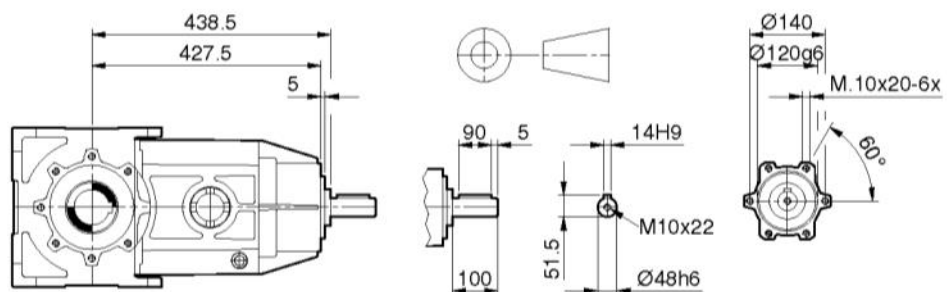

IEC	80	90 S / L	100	112	132 S / M	160	180
X / Y / Z1	159/238/138	176/255-280/149	195/314/160	219/328/172	258/368-410/192	310/486/235	320/580/245
X1 (B5) / S	200/22	200/22	250/22	250/22	300/22	350/35	350/35
X1 (B14) / S	---	---	---	---	200/22	250/22	300/22
L (RO63)	449.5	449.5	449.5	449.5	449.5	462.5	462.5

Dimensioni e pesi non impegnativi

Not binding dimensions and weights

unverbindliche Abmessungen u. Gewichte

### RV63

**MRV  
FRV**

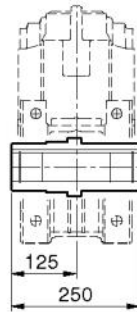
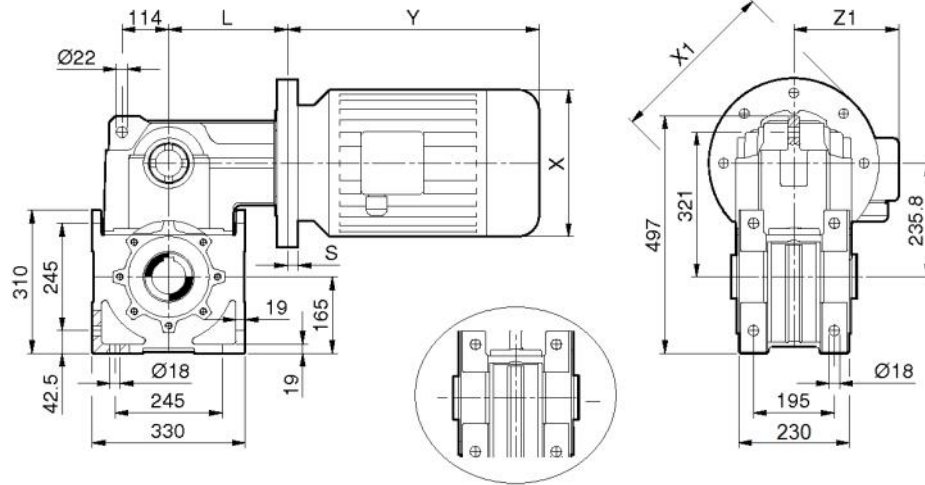

**AC70**

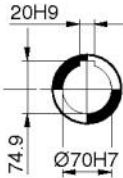

**AC60**

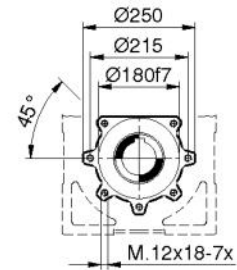
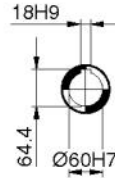

**RV**

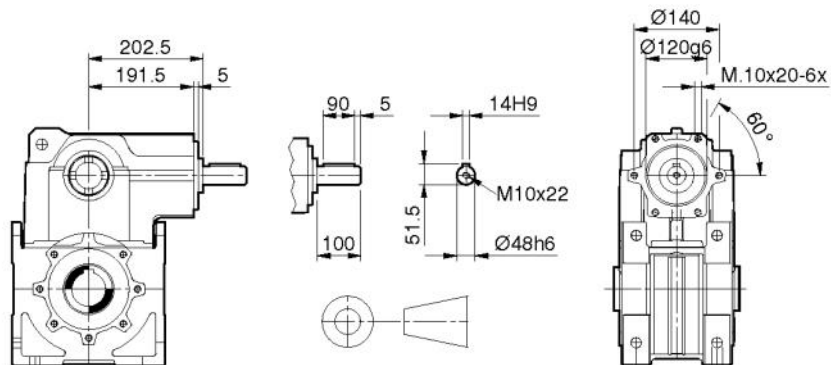

RV	63	63	63	63	63	63	63
IEC	80	90 S / L	100	112	132 S / M	160	180
X / Y / Z1	159/238/138	176/255-280/149	195/314/160	219/328/172	258/368-410/192	310/486/235	320/580/245
X1 (B5) / S	200/22	200/22	250/22	250/22	300/22	350/35	350/35
X1 (B14) / S	---	---	---	---	200/22	250/22	300/22
L (RV63)	205.5	205.5	205.5	205.5	205.5	218.5 (205.5)	218.5 (205.5)

Dimensioni e pesi non impegnativi

Not binding dimensions and weights

unverbindliche Abmessungen u. Gewichte

RO63-RV63

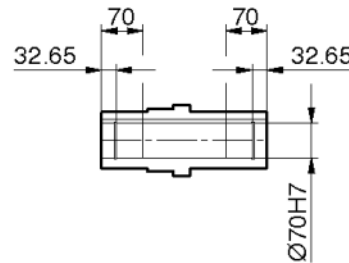
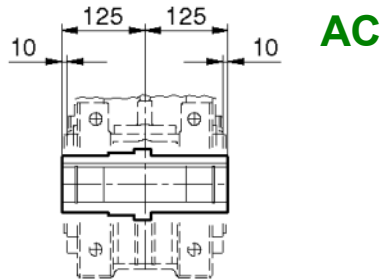

AS

AD

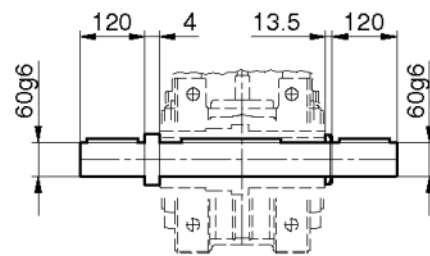
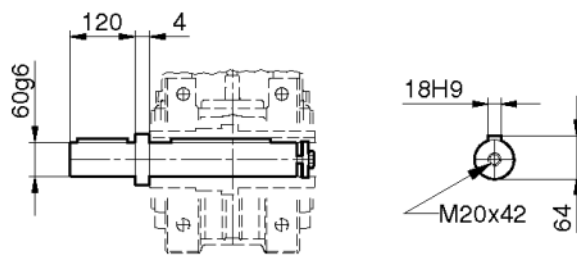

ACC

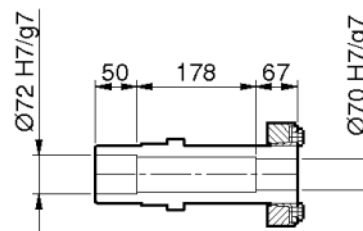
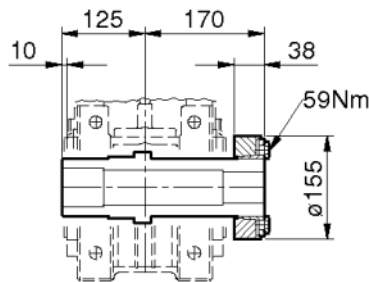

ACS

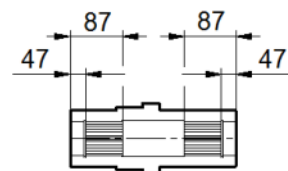
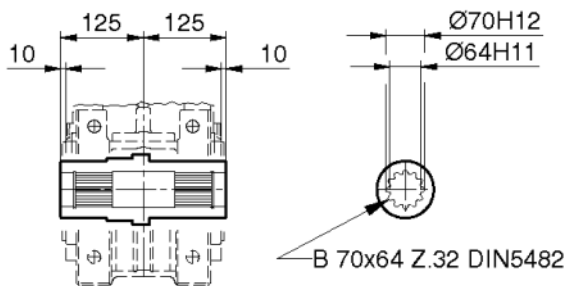

- Dimensioni del perno macchina: pagine 84-86
- Machine shaft dimensions: pages 84-86
- Maschinenwelle Abmessungen: Seiten

**RO63-RV63**

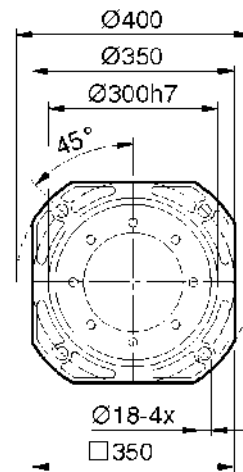
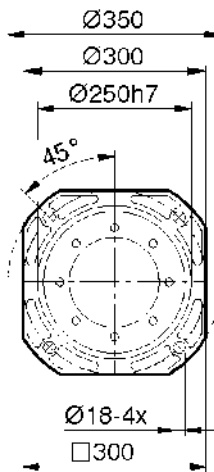
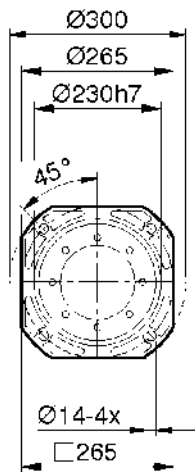
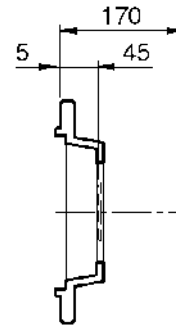
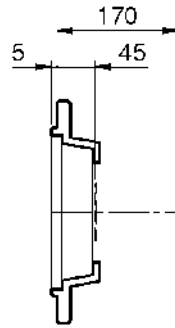
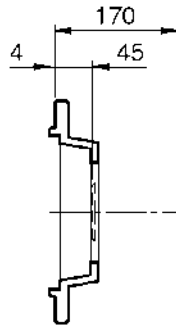
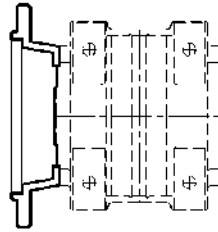

Dimensioni e pesi non impegnativi

Not binding dimensions and weights

unverbindliche Abmessungen u. Gewichte

RO63-RV63

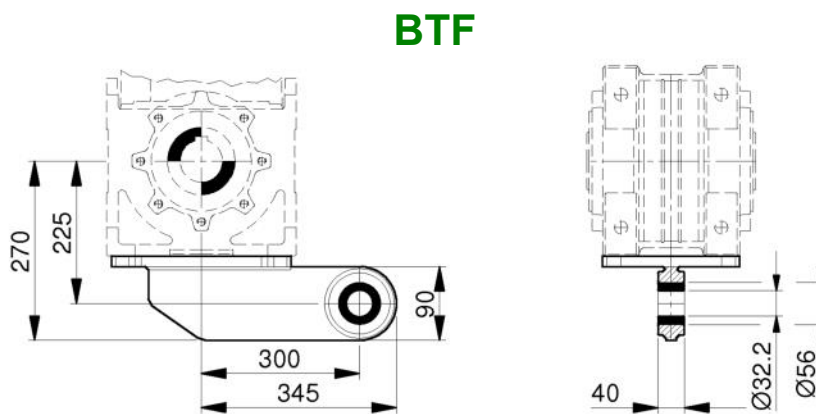
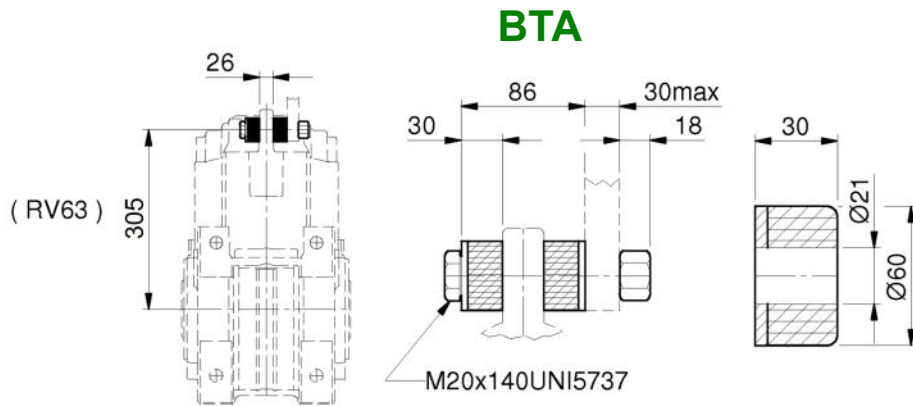

La tabella fornisce le dimensioni dell'albero macchina adatto ad inserirsi nell'albero cavo di uscita AC con chiavetta standard.

The table shows the dimensions of the machine shaft to be fitted into the AC hollow output shaft with standard key .

Die Tabelle gibt die Abmessungen der Maschinenwelle an, geeignet zur Einsetzung der Ausgangskeilhohlwelle AC mit externer Schrumpfscheibe.

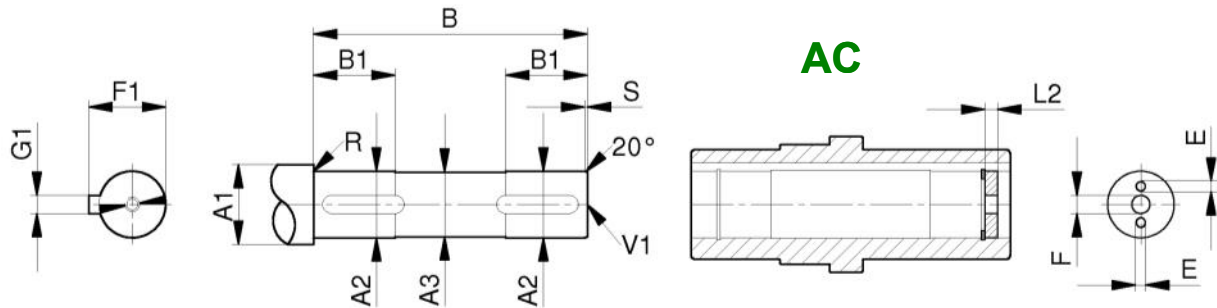

- Montaggio  
Mounting  
Montage

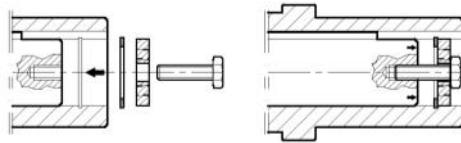

- Smontaggio  
Disassembly  
Demontage

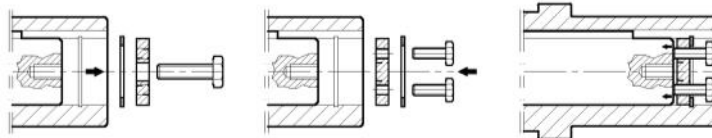

Size	A1	A2	A3	B	B1	E	F	F1	G1	L2	R	S	V1
RO13 - RV13	40	<b>30</b>	29	98	35	M6	11	33	8	5.5	1	2	M10x22
	35	<b>25</b>	24	98	35	M6	9	28	8	4.5	1	2	M8x19
RO22 - RV23	45	<b>35</b>	34	113.5	40	M8	11	38	10	7	1	2	M10x22
	40	<b>30</b>	29	113.5	40	M6	11	33	8	7	1	2	M10x22
RO32 - RV33	50	<b>40</b>	39	133.5	45	M8	13	43	12	7	1	2	M12x28
	45	<b>35</b>	34	133.5	45	M8	11	38	10	7	1	2	M10x22
RO42 - RV43	60	<b>50</b>	49	155.5	55	M10	17	53.5	14	8	1.5	3	M16x36
	55	<b>45</b>	44	155.5	55	M10	17	48.5	14	8	1.5	3	M16x36
	50	<b>40</b>	39	155.5	55	M8	13	43	12	8	1.5	3	M12x28
RO52 - RV53	75	<b>60</b>	59	185	65	M12	17	64	18	12.5	2	4	M16x36
	70	<b>55</b>	54	185	65	M12	17	59	16	12.5	2	4	M16x36
	65	<b>50</b>	49	185	65	M10	17	53.5	14	12.5	2	4	M16x36
RO62 - RV3	85	<b>70</b>	69	205	70	M12	21	74.5	20	12.5	2	4	M20x42
	80	<b>65</b>	64	205	70	M12	21	69	18	12.5	2	4	M20x42
	75	<b>60</b>	59	205	70	M12	21	64	18	12.5	2	4	M16x36

Dimensioni e pesi non impegnativi

Not binding dimensions and weights

unverbindliche Abmessungen u. Gewichte

La tabella fornisce le dimensioni dell'albero macchina adatto ad inserirsi nell'albero cavo di uscita ACC con calettatore esterno.

The table shows the dimensions of the machine shaft to be fitted into the ACC hollow output shaft with shrink disk .

Die Tabelle gibt die Abmessungen der Maschinenwelle an, geeignet zur Einsetzung der Ausgangskeilhohlwelle ACC mit externer Schrumpfscheibe.

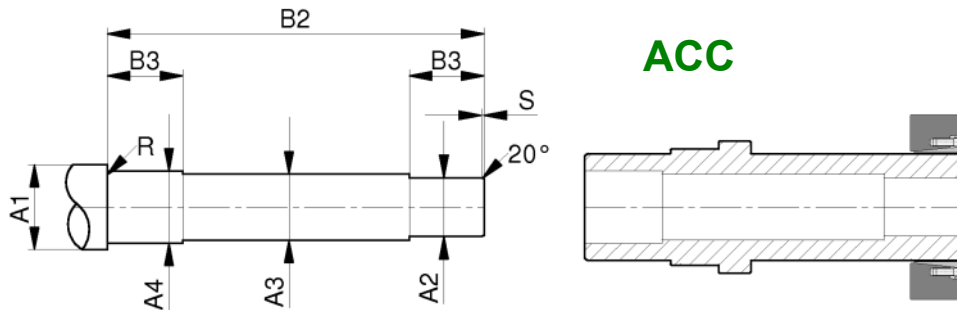

Size	A1	A2	A3	A4	B2	B3	R	S
RO13 - RV13	40	<b>30</b>	29	32	144	34	1	2
RO23 - RV23	45	<b>35</b>	34	37	167	39	1	2
RO33 - RV33	50	<b>40</b>	39	42	189	49	1	2
RO43 - RV43	60	<b>50</b>	49	52	220	49	1.5	3
RO53 - RV53	75	<b>60</b>	59	62	267	49	2	4
RO63 - RV63	85	<b>70</b>	69	72	294	49	2	4

Il calettatore è basato sullo sperimentato principio del cuneo per creare un accoppiamento meccanico per interferenza senza chiave.

Il serraggio assiale delle viti è convertito in pressione di contatto radiale fra albero e mozzo, causandone lo stabile calettamento.

#### Montaggio

Pulire accuratamente le superfici di contatto dell'albero e del mozzo e applicare un leggero velo d'olio. Serrare le viti in modo graduale ed uniforme fino a raggiungere la coppia di serraggio. Non usare oli contenenti bisolfuro di molibdeno che originano notevole riduzione del coefficiente d'attrito. Durante il serraggio delle viti non avviene nessun spostamento assiale del mozzo rispetto all'albero.

#### Smontaggio

Allentare le viti con sequenza continua e graduale senza estrarre le viti dalle filettature.

In caso di riutilizzo, applicare alle viti e superfici coniche un lubrificante in pasta per garantire un coefficiente d'attrito di 0.04. Coppie di serraggio, tolleranze e rugosità secondo le specifiche del costruttore.

The shrink-disk fit relies upon the proven wedge principle to create a keyless mechanical interference fit.

Screw axial locking tension is converted into radial contact pressure on the shaft/hub connection, making the shrink fit steady.

#### Assembly

Carefully clean the shaft/hub contact surfaces and grease with a fine layer of oil. Tighten the screws gradually and evenly until the locking torque is reached.

Do not use lubricants containing molybdenum bisulphite that originates notable lowering of the friction coefficient. No axial hub shifting occurs as regards the shaft when are tightening the screws.

#### Disassembly

Loose the screws in a continuous and even way without removing the screws.

In case of further assembly, apply a lubricant paste on screws and tapered surfaces to guarantee a friction coefficient of 0.04.

Locking torques, tolerances and roughness according to manufacturer's specifications.

Die Schrumpfscheibe liegt dem versuchten Prinzip des Keiles zugrunde, um eine mechanische Kupplung zur Interferenz ohne Keilnut zu kreieren. Das axiale Anziehen der Schrauben wurde in radialem Anpressdruck zwischen Welle und Nabe umgesetzt, verursacht Stabilität der Schrumpfscheibe.

#### Montage

Sorgfältig die Kontaktflächen der Welle und der Nabe reinigen und ein wenig Öl aufbringen. Die Schrauben gradual und einheitlich anziehen bis zur Erzielung des Anzugsdrehmoment. Verwenden Sie keine Öle mit Molybdänsulfid, wegen erheblicher Reduzierung des Reibungskoeffizienten. Während des Anziehens der Schrauben erfolgt keine axiale Verschiebung der Nabe gegenüber der Welle.

#### Demontage

Lösen Sie die Schrauben kontinuierlich und schrittweise, ohne die Schrauben aus dem Gewinde zu entfernen. Im Falle der Wiederverwendung, tragen Sie auf den Schrauben und Kegelflächen eine Schmierpaste, um ein Reibungskoeffizient von 0.04 zu garantieren. Drehmomente, Toleranzen und Rauigkeit nach Angaben des Herstellers.

La tabella fornisce le dimensioni dell'albero macchina adatto ad inserirsi nell'albero cavo di uscita scanalato ACS.

The table shows the dimensions of the machine shaft to be fitted into the ACS splined hollow output shaft.

Die Tabelle gibt die Abmessungen der Maschinenwelle an, geeignet zur Einsetzung der Ausgangskeilhohlwelle ACS mit externer Schrumpfscheibe.

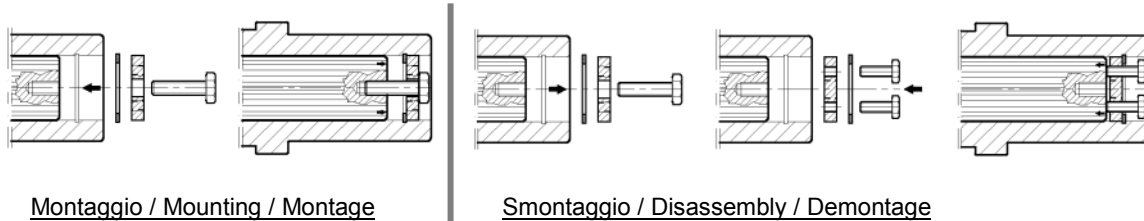
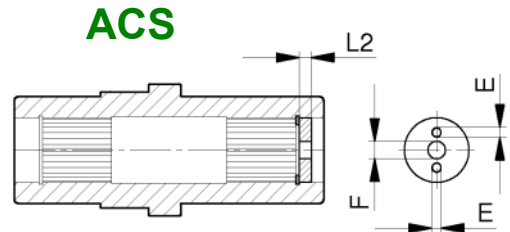
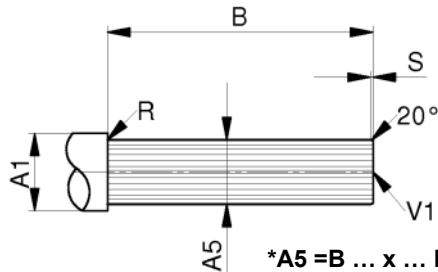

Size	A1	A5	B	E	F	L2	R	S	V1
RO13- RV13	40	30x27	98	M6	11	5.5	1	2	M8x19
RO23 - RV23	45	35x31	113.5	M8	11	7	1	2	M10x22
RO33 - RV33	50	40x36	133.5	M8	13	7	1	2	M10x22
RO43 - RV43	60	50x45	155.5	M10	17	8	1.5	3	M16x36
RO53 - RV53	75	60x55	185	M12	17	12.5	2	4	M16x36
RO63 - RV63	85	70x64	205	M12	21	12.5	2	4	M20x42

Gli alberi scanalati hanno denti che ingrano con corrispondenti scanalature di un pezzo accoppiante e gli trasferiscono la coppia mantenendo la corrispondenza angolare fra loro. Alternativi al collegamento cava/chiavetta, gli scanalati forniscono maggior coppia e maggior durata alla fatica.

Spline shafts have teeth that mesh with grooves in a mating piece and transfer torque to it, maintaining the angular correspondence between them. As alternative to key/keyway connection, splines provide higher torque and longer fatigue lifetime.

Die Keilwellen haben Zähne mit entsprechenden Nuten eines Kupplungsstückes und übertragen das Drehmoment mit Einhaltung des Winkels zwischen Ihnen. Alternativ zur Verbindung von Schlüssel/Keilnut, die Keilwellen bieten mehr Drehmoment und höhere Lebensdauer an.



Le posizioni degli accessori, nelle definizioni RH e LH, fanno riferimento alla posizione di montaggio H1 a pag. 14 e sono viste dal lato inferiore del riduttore RO o RV.

Il lato della carcassa con la vite come indicata è la esatta identificazione del lato di riferimento.

Se l'accessorio viene richiesto montato in fabbrica, l'ordine è considerato in sospenso fino alla determinazione del lato RH o LH.

Per altre posizioni di montaggio, riferirsi al Servizio Clienti.

Accessory positions, here defined as RH and LH, refer to H1 mounting position at page 14 and are seen from the bottom side of the gearbox RO or RV accordingly.

The housing side with the screw as shown is the right identification of the reference side.

If the accessory is requested in-house assembled, the order is held-on until RH or LH side is defined.

For other mounting positions, please refer to the Customer Service.

Die Zubehörbaulagen, hier als RH und LH definiert, beziehen sich auf H1 Einbaulage auf Seite 14 und werden von der Unterseite des Getriebes RO oder RV entsprechend gesehen. Die Seite des Gehäuses mit der Schraube, wie gezeigt ist die genaue Identifizierung der Referenzseite.

Wenn das Zubehör am haus angeforderte gebaut wird die Reihenfolge gehalten, bis Seite RH oder LH definiert ist.

Für andere Einbaulagen entnehmen Sie bitte dem Kundendienst beziehen.

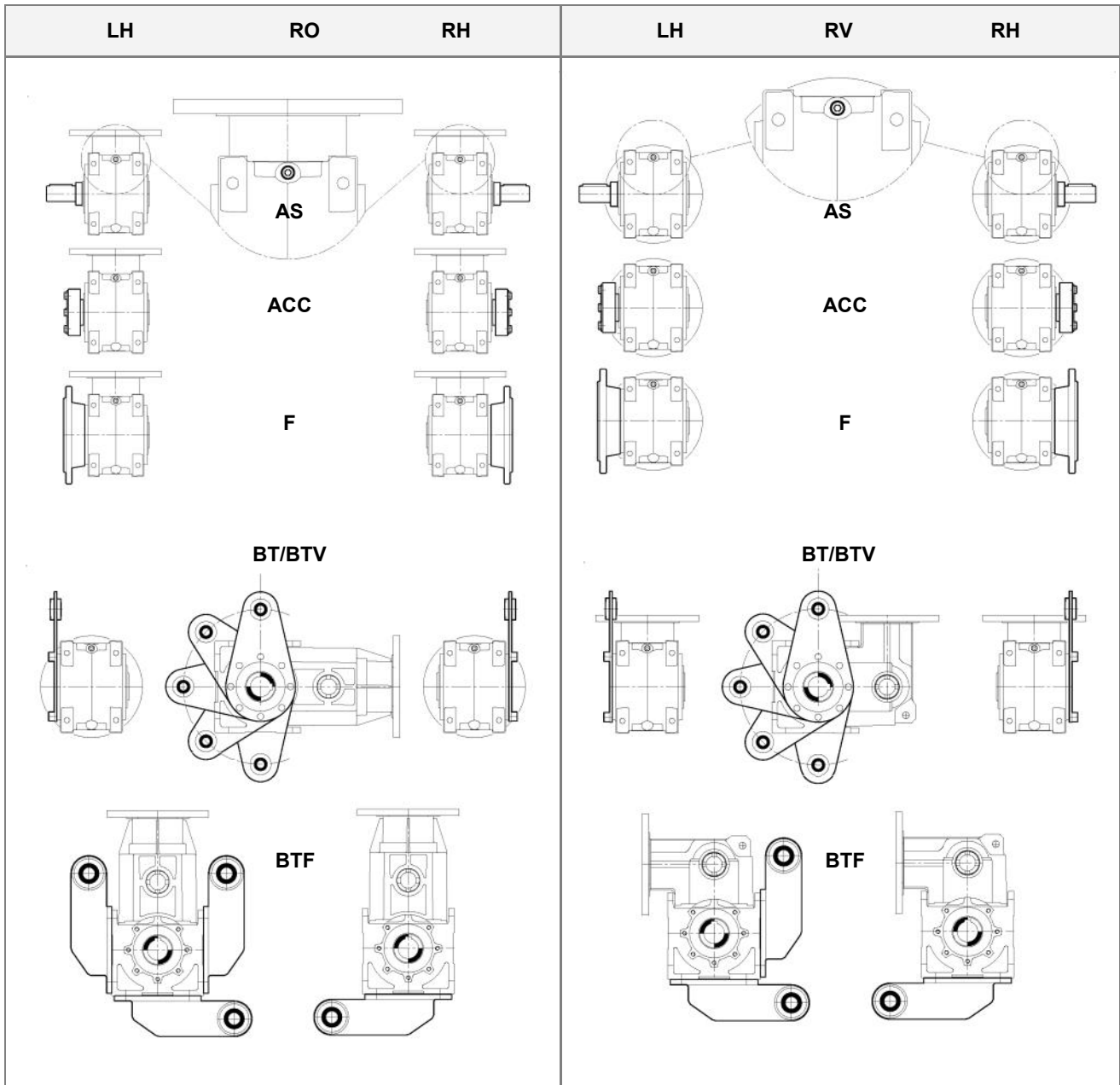

## RO

### Versione in linea In-line version Inlineausführung

- A - Flangia motore  
Motor flange  
Motorflansch
- B - Coperchio entrata 3 coppie + ingranaggi T1. T2. T3  
Three-stage input cover + T1. T2 and T3 gears  
Dreistufige Eingangsdeckel u. Räder T1. T2. T3
- C - Carcassa + ingranaggi T4. T5. T6  
Housing + T4. T5. T6 gears  
Gehäuse u. Räder T4. T5. T6
- D - Flangia di uscita  
Output flange  
Abtriebsflansch

- 
- Rotazione entrata / uscita
  - Input / output rotation
  - Drehrichtung

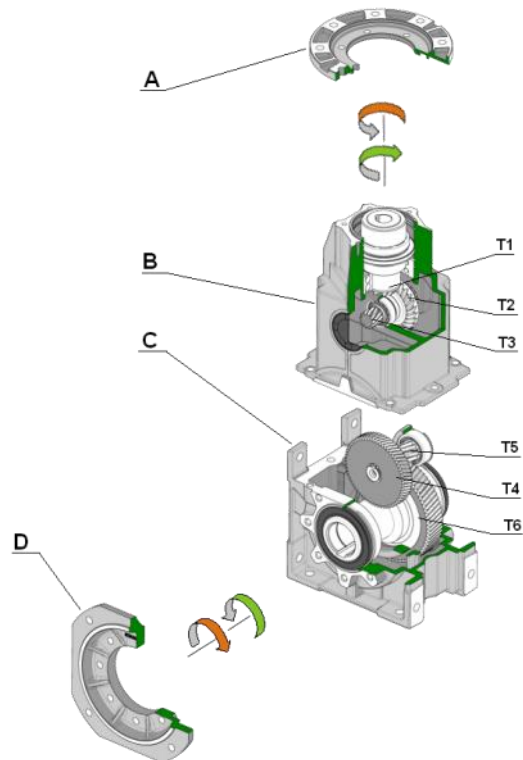

## RV

### Versione a squadra Right angle version Winkelausführung

- A - Flangia motore  
Motor flange  
Motorflansch IEC
- B - Coperchio entrata 3 coppie + ingranaggi T1. T2. T3  
Three-stage input cover + T1. T2. T3 gears  
Dreistufige Eingangsdeckel u. Räder T1. T2. T3
- C - Carcassa + ingranaggi T4. T5. T6  
Housing + T4. T5. T6 gears  
Gehäuse u. Räder T4. T5. T6
- D - Flangia uscita  
Output flange  
Abtriebsflansch

- 
- Rotazione entrata / uscita
  - Input / output rotation
  - Drehrichtung

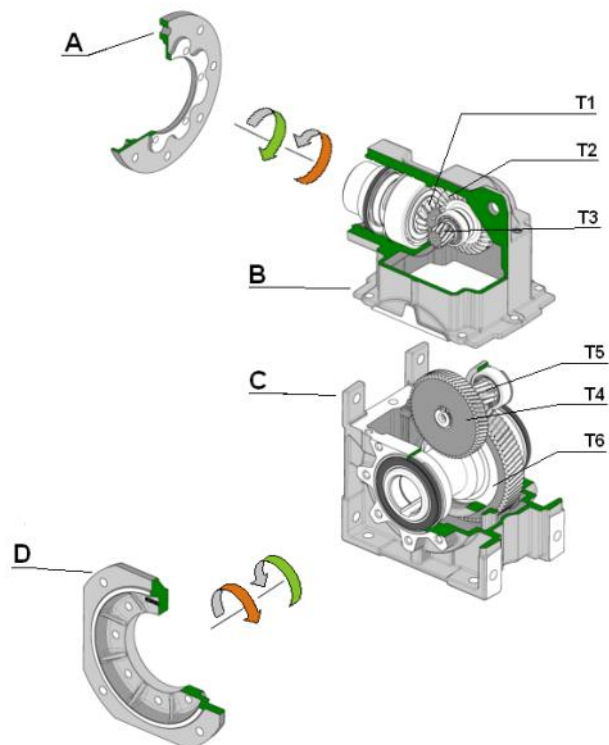

Votaggio e frequenza	Voltage and frequency	Spannung u. Frequenz						
	<table border="1" style="width: 100%; border-collapse: collapse;"> <thead> <tr> <th style="text-align: center;">Valori nominali Rated values Nennwerte</th> <th style="text-align: center;">Valori utilizzabili Usable values Benutzbarwerte</th> </tr> </thead> <tbody> <tr> <td style="text-align: center;">230/400V 50Hz</td> <td style="text-align: center;">240/415V 50Hz 220/380V 50Hz</td> </tr> <tr> <td style="text-align: center;">277/480V 60 Hz</td> <td style="text-align: center;">265/460V 60Hz 260/440V 60Hz</td> </tr> </tbody> </table>	Valori nominali Rated values Nennwerte	Valori utilizzabili Usable values Benutzbarwerte	230/400V 50Hz	240/415V 50Hz 220/380V 50Hz	277/480V 60 Hz	265/460V 60Hz 260/440V 60Hz	
Valori nominali Rated values Nennwerte	Valori utilizzabili Usable values Benutzbarwerte							
230/400V 50Hz	240/415V 50Hz 220/380V 50Hz							
277/480V 60 Hz	265/460V 60Hz 260/440V 60Hz							
	<table style="width: 100%;"> <tr> <td style="width: 33%; text-align: center;"> <div style="background-color: #e0e0e0; width: 20px; height: 10px; margin-bottom: 5px;"></div>                     - Servizio normale                 </td> <td style="width: 33%; text-align: center;">                     - Normal duty                 </td> <td style="width: 33%; text-align: center;">                     - Normaldienst                 </td> </tr> <tr> <td style="width: 33%; text-align: center;"> <div style="background-color: #808080; width: 20px; height: 10px; margin-bottom: 5px;"></div>                     - Servizio pesante e limitato                 </td> <td style="width: 33%; text-align: center;">                     - Heavy duty but limited                 </td> <td style="width: 33%; text-align: center;">                     - Schwerdienst aber begrenzt                 </td> </tr> </table>	<div style="background-color: #e0e0e0; width: 20px; height: 10px; margin-bottom: 5px;"></div> - Servizio normale	- Normal duty	- Normaldienst	<div style="background-color: #808080; width: 20px; height: 10px; margin-bottom: 5px;"></div> - Servizio pesante e limitato	- Heavy duty but limited	- Schwerdienst aber begrenzt	
<div style="background-color: #e0e0e0; width: 20px; height: 10px; margin-bottom: 5px;"></div> - Servizio normale	- Normal duty	- Normaldienst						
<div style="background-color: #808080; width: 20px; height: 10px; margin-bottom: 5px;"></div> - Servizio pesante e limitato	- Heavy duty but limited	- Schwerdienst aber begrenzt						

Classe di isolamento	Insulation class	Isolationsklasse
	<p>a) margine di sicurezza safety margin Sicherheitspanne</p> <p>b) sovratemperatura ammissibile admissible temperature Annehmbar Übertemperatur</p> <p>c) temperatura ambiente convenzionale conventional ambient temperature Konventionelle Zimmertemperatur</p>	

Coefficienti di Altitudine e di Temperatura ( k <sub>AT</sub> )	Altitude and Temperature Factors ( k <sub>AT</sub> )	Höhe u. Temperatur Faktoren ( k <sub>AT</sub> )
	<ul style="list-style-type: none"> <li>- Condizioni convenzionali Conventional conditions Konventionalbedingungen</li> <li>1000 m [3285 ft] - altitudine s.l.m. altitude above sea level über dem Meeresspiegel</li> <li>40 °C [104 °F] - temperatura ambiente ambient temperature Zimmertemperatur</li> <li>-15 °C [5 °F] - min. temperatura ambiente dell'aria min. ambient air temperature Minimum Zimmerlufttemperatur</li> <li>≤ 60% - umidità relativa relative humidity Relative Feuchtigkeit</li> </ul>	
<div style="border: 1px solid black; padding: 5px; display: inline-block;"> <math>P_{AT} = P_1 * k_{AT} [ Kw ]</math> </div>		

La Direttiva Europea 94/9/CE-ATEX riguarda non solo gli apparecchi elettrici ma tutte le macchine e gli organi di comando che sono destinati. soli o combinati. ad essere utilizzati in atmosfere potenzialmente esplosive nei territori della Comunità Europea.

I riduttori VARVEL-ATEX sono costruiti con

- carcassa e coperchi in materiale metallico. contenenti gli elementi di trasmissione montati su cuscinetti a sfere o a rulli;
- paraolio in Viton sugli alberi di entrata e di uscita;
- quantità di lubrificante idonea per assicurare il funzionamento del progetto;
- viteria sigillata con pasta frena-filetti.

I riduttori VARVEL-ATEX sono identificati nella Direttiva come «componenti», pertanto privati di loro funzione autonoma. ma essenziali per il funzionamento di apparecchi e di sistemi di protezione destinati alla produzione. trasporto. immagazzinamento. misurazione. regolazione e conversione d'energia e trasformazione dei materiali che. per le loro proprie potenzialità d'inflammabilità. rischiano di provocare l'innesco di un'esplosione.

#### Terminologia Direttiva ATEX:

- **Gruppo**  
Gruppo I - utilizzazione in miniera  
Gruppo II - utilizzazione in industrie di superficie
- **Categoria**  
Categoria 1 - esposizione continuata in ambiente possibilmente esplosivo con durata > 1000 ore/anno o con frequenti malfunzionamenti  
Categoria 2 - esposizione occasionale in ambiente possibilmente esplosivo con durata fra 10 e 1000 ore/anno o con saltuari malfunzionamenti  
Categoria 3 - esposizione poco probabile in ambiente possibilmente esplosivo e se avvenuta. si verifica per un breve periodo con durata inferiore a 10 ore/anno
- **Lettere "G" e "D"**  
Presenza di gas (G) e di polveri (D)
- **Lettere "c" e "k"**  
Indici di sicurezza di costruzione (c) e di immersione in liquido (k).
- **IP66**  
Grado di protezione
- **T<sub>max</sub> e T<sub>amb</sub>**  
Temperature massima di superficiale (T<sub>max</sub>) e d'ambiente (T<sub>amb</sub>).

The European Directive 94/9/EC-ATEX relates not only to electric devices but to all the machines and driving units destined. alone or combined. to operate in potentially explosive environments within European Community territory.

The gearboxes VARVEL-ATEX are manufactured

- with metallic housings and covers. containing the driving gears fitted on ball or roller bearings;
- Viton oil seals on input and output shafts;
- the needed oil quantity to ensure the unit operation;
- sealed thread screws with sealing paste.

The gearboxes VARVEL-ATEX are identified in the Directive as «components», therefore stripped away any autonomous function. but fundamental to operation of units and protection systems destined to production. transport. storage. measuring. adjusting and conversion of energy and material transformation that because of their own inflammable potentiality. risk to induce an explosion trigger.

#### Directive-ATEX terminology:

- **Group**  
Group I - use in mine  
Group II - use in surface industries
- **Category**  
Category 1 - continuous exposure in possibly explosive environment for more than 1000 hrs/year or with frequent malfunctioning  
Category 2 - occasional exposure in possibly explosive environment for 10 to 1000 hrs/year or with sporadic malfunctioning  
Category 3 - not very likely exposure in possibly explosive environment and if happened. not longer than 10 hours/year
- **Letters "G" and "D"**  
Gas (G) or dust (D) presence
- **Letters "c" and "k"**  
Safety indication of construction (c) and immersion in liquid (k)
- **IP66**  
Protection grade
- **T<sub>max</sub> and T<sub>amb</sub>**  
Surface (T<sub>max</sub>) and Ambient (T<sub>amb</sub>) max. temperature

Die Europäische Richtlinie 94/9/EG-ATEX gilt nicht für elektrische Ausrüstungen. sondern auch für alle Arten von Maschinen und Steuerungsteile. allein oder kombiniert. für den Gebrauch in potentiell explosiver Atmosphäre in den Gebieten der Europäischen Gemeinschaft. Die VARVEL-ATEX Getriebe sind hergestellt mit

- Gehäuse und Deckel in Metall. beinhaltet Getriebe montiert auf Kugel- oder Rollenlager;
- Viton-Dichtungen auf Eingangs- und Ausgangswellen;
- ausreichende Ölmenge. um das Funktionieren des Projekts zu gewährleisten;
- Schrauben sind mit Schraubensicherungs-paste abgedichtet.

VARVEL-ATEX Getriebe sind in der Richtlinie als "Komponenten" identifiziert. von daher ihre autonome Funktion. aber wesentlich für den Betrieb von Geräten und Schutzsystemen für die Produktion. Transport. Lagerung. Messung. Regelung und Umwandlung von Energie und Verarbeitung von Materialien. die wegen ihrer eigenen potenzieller Entflammbarkeit. die Auslösung einer Explosion riskieren.

#### Terminologie ATEX Richtlinie

- **Gruppe**  
Gruppe I - Verwendung in Minen  
Gruppe II - Verwendung in Oberflächen Branchen
- **Kategorien**  
Kategorie 1 - kontinuierliche Exposition in möglicher explosiver Umgebung bei Dauer > 1000 Stunden/Jahr oder mit häufigen Störungen  
Kategorie 2 - gelegentliche Exposition in möglicher explosiver Umgebung mit Dauer zwischen 10 und 1000 Stunden/Jahr o mit gelegentlichen Fehlfunktionen  
Kategorie 3 - unwahrscheinliche Exposition. in möglicher explosiver Umgebung und wenn dies eintritt. bei einem kurzen Zeitraum mit Dauer von weniger als 10 Stunden/Jahr
- **Buchstaben "G" und "D"**  
Vorhandensein von Gas (G) und Staub (D)
- **Buchstaben "c" und "k"**  
Indiz der Bausicherheit (c) und Eintauchen in Flüssigkeit (k).
- **IP66**  
Schutzgrad
- **T<sub>max</sub> e T<sub>amb</sub>**  
Maximale Oberflächentemperatur (T<sub>max</sub>) und Umgebungstemperatur (T<sub>amb</sub>).

## ATEX - Direttiva Europea 94/9/CE - European Directive 94/9/EC - Europäische Richtlinie 94/9/EU **RO-RV**

Le serie VARVEL RO e RV sono conformi alle richieste di progetto esatte dal Gruppo II, Categoria 2 o 3 e per funzionamento in zone con pericolo di esplosione in presenza di gas (zona 1 e zona 2) e di polveri combustibili (zona 21 e zona 22).

I prodotti VARVEL-ATEX sono marcati

**II 2 GD ck IP66**  
T<sub>max</sub>=135°C

VARVEL RO and RV series are conforming with design requirements asked by Group II, Category 2 or 3, and for operation in possible hazardous zones in presence of gas (zones 1 and 2) and combustible dust (zones 21 and 22).

The VARVEL-ATEX products are marked

**II 2 GD ck IP66**  
T<sub>max</sub>=135°C

Die Serie VARVEL RO u. RV sind Übereinstimmung mit die Konstruktionsanforderungen gebeten von Gruppe II, Kategorie 2 oder 3 und für Betrieb in Zonen mit Explosionsgefahr in der Gegenwart von Gas (Zone 1 und Zone 2) und Staub (Zone 21 und Zone 22).

Die Produkte VARVEL-ATEX sind markiert

**II 2 GD ck IP66**  
T<sub>max</sub>=135°C

Gruppo Group Gruppe	Categoria Category Kategorie	Gas. Vapori. Nebbie Gas. Vapours. Cloud Gas. Dämpfe. Nebel	Zona Zone	Polveri Dust Stäube
I (a)	M1 (c) M2 (d)			
II (b)	1 (c)	G (0)		D (20)
	2 (d)	G (1)		D (21)
	3 (e)	G (2)		D (22)

### Attenzione

I riduttori VARVEL-ATEX **non sono certificati** per funzionamento nelle aree in **colore grigio**.

- (a) - Miniere
- (b) - Industrie di superficie
- (c) - Livello di protezione: molto elevato
- (d) - Livello di protezione: elevato
- (e) - Livello di protezione: normale
- (0) - Presenza continua di gas
- (1) - Presenza discontinua di gas
- (2) - Presenza occasionale di gas
- (20) - Presenza continua di polveri
- (21) - Presenza discontinua di polveri
- (22) - Presenza occasionale di polveri

### Warning

The VARVEL-ATEX gearboxes **are not certified** for operation in **shaded areas**.

- (a) - Mines
- (b) - Surface industries
- (c) - Protection level: very high
- (d) - Protection level: high
- (e) - Protection level: normal
- (0) - Continuous presence of gas
- (1) - Discontinuous presence of gas
- (2) - Occasional presence of gas
- (20) - Continuous presence of dust
- (21) - Discontinuous presence of dust
- (22) - Occasional presence of dust

### Vorsicht !

Die Getriebe VARVEL-ATEX sind für den Anbau in die **Graufarbezone nicht zertifiziert**.

- (a) - Bergwerke
- (b) - Oberfläche-Industrien
- (c) - Schutzklasse: sehr hoch
- (d) - Schutzklasse: hoch
- (e) - Schutzklasse: normal
- (0) - ständige Gegenwart von gas
- (1) - nicht ständige Gegenwart von gas
- (2) - gelegentliche Gegenwart von gas
- (20) - ständige Gegenwart von Stäube
- (21) - nicht ständige Gegenwart von Stäube
- (22) - gelegentliche Gegenwart von Stäube

<b>Estratto delle ISTRUZIONI D'USO E MANUTENZIONE</b> (manuale completo su <a href="http://www.varvel.com">www.varvel.com</a> )	<b>Abstract of OPERATION AND MAINTENANCE INSTRUCTIONS</b> (complete manual on <a href="http://www.varvel.com">www.varvel.com</a> )	<b>Zusammenfassung der BETRIEBS- u. WARTUNGSANWEISUNGEN</b> (vollständiges Handbuch auf <a href="http://www.varvel.com">www.varvel.com</a> )
<p>Ai sensi della Direttiva Macchine 2006/42/CE e relativa Linea Guida, i riduttori e i variatori di velocità sono considerati "elementi separati di macchine che non hanno un'applicazione specifica e che sono destinati ad essere incorporati nella macchina. La macchina completa dotata di questi componenti deve soddisfare i requisiti essenziali pertinenti di sicurezza e tutela della salute" della citata Direttiva.</p> <p><b>Installazione</b>                      Accertarsi che il gruppo da installare abbia le caratteristiche atte a svolgere la funzione richiesta e che la posizione di montaggio sia coerente con quanto ordinato. Tali caratteristiche sono deducibili dalla targhetta d'identificazione apposta sul riduttore. Effettuare la verifica della stabilità del montaggio affinché non si verifichino vibrazioni o sovraccarichi durante il funzionamento.</p> <p><b>Funzionamento</b>                      Il riduttore può essere collegato per rotazione oraria o antioraria. Arrestare immediatamente il riduttore in caso di funzionamento difettoso o di rumorosità anomala. Rimuovere il difetto o ritornare l'apparecchio alla fabbrica per un'adeguata revisione. Se la parte difettosa non è sostituita, anche altri componenti possono essere danneggiati con conseguenti ulteriori danneggiamenti e più scarsa possibilità di risalire alle cause.</p> <p><b>Manutenzione</b>                      Sebbene i gruppi siano provati con funzionamento senza carico prima della spedizione, è consigliabile non usarli a carico massimo durante le prime 20-30 ore di funzionamento affinché le parti interne possano adattarsi reciprocamente. I riduttori sono spediti già riempiti con olio sintetico a lunga durata e, se occorre sostituire o rabboccare il lubrificante, non mescolare oli a base sintetica con oli a base minerale.</p> <p><b>Movimentazione</b>                      In caso di sollevamenti con paranco, utilizzare posizioni di aggancio sulla struttura della carcassa, golfari ove esistenti, fori dei piedi o sulle flange, evitando tutte le parti mobili.</p> <p><b>Verniciatura</b>                      Qualora il gruppo subisca una verniciatura successiva, è necessario proteggere accuratamente gli anelli di tenuta, i piani di accoppiamento e gli alberi sporgenti.</p> <p><b>Conservazione prolungata a magazzino</b>                      Per permanenze maggiori di tre mesi, è consigliata l'applicazione di antiossidanti su alberi esterni e piani lavorati, e di grasso protettivo sui labbri dei paraolio.</p> <p><b>Gestione Ambientale del prodotto</b>                      In conformità alla Certificazione Ambientale ISO 14001, sono suggerite le seguenti indicazioni per lo smaltimento del nostro prodotto:</p> <ul style="list-style-type: none"> <li>- i componenti del gruppo che vengono rottamati debbono essere consegnati a centri di raccolta autorizzati per i materiali metallici;</li> <li>- gli oli ed i lubrificanti raccolti dal gruppo devono essere smaltiti consegnandoli ai Consorzi Oli esauriti;</li> <li>- gli imballi a corredo dei gruppi (pallet, cartone, carta, plastica, ecc..) vanno avviati per quanto più possibile al recupero/riciclo, consegnandoli a ditte autorizzate per le singole classi di rifiuto.</li> </ul>	<p>Under the terms of the Machine Directive 2006/42/EC and relevant Guidelines, the speed gearboxes and variators are considered as "machines' separate elements not having a specific application and meant for being incorporated onto the machine. The complete machine and equipped with such components must comply with the essential and relevant requisites for safety and health preservation" of the mentioned Directive.</p> <p><b>Installation</b>                      Check if the unit to be installed, is properly selected to perform the required function and that its mounting position complies with the order. The nameplate reports such information. Check mounting stability to ensure the unit runs without vibrations or overloads.</p> <p><b>Running</b>                      The unit may be connected for clockwise or counter-clockwise rotation. The unit must be stopped as soon as defective running or unexpected noise occur, remove the faulty part or return the unit to the factory for checking. If the faulty part is not replaced, other parts can also be affected, causing more severe damage and making the identification of initial cause more difficult.</p> <p><b>Maintenance</b>                      Although the units are no-load run tested in the factory before despatch, it is recommended not to run them at maximum load for the first 20-30 running hours to allow the proper running in. The gearboxes are delivered already filled with long-life synthetic oil and, in case of replacement or topping, do not mix with mineral lubricants.</p> <p><b>Handling</b>                      When hoisting, use relevant housing locations or eyebolts if provided, or foot or flange holes. Never hoist on any moving part.</p> <p><b>Painting</b>                      Carefully protect oil seals, coupling faces and shafts when units are re-painted.</p> <p><b>Long-term storage</b>                      For storages longer than three months, apply anti-oxidants onto shafts and machined surfaces, and protective grease on oil seal lips.</p> <p><b>Product's Environmental Management</b>                      In conformity with Environmental Certification ISO 14001, we recommend the following to dispose of our products:</p> <ul style="list-style-type: none"> <li>- scraped components of the units to be delivered to authorized centres for metal object collection;</li> <li>- oils and lubricants drained from the units to be delivered to Exhausted Oil Unions;</li> <li>- packages (pallets, carton boxes, paper, plastic, etc..) to lead into regeneration/recycling circuits as far as possible, by delivering separate waste classes to authorized companies.</li> </ul>	<p>Gemäß der Maschinenrichtlinie 2006/42/EC und der zugehörigen Richtlinie gelten Getriebe und Verstellgetriebe als "separate Elemente von Maschinen, die keine spezifische Anwendung haben und die in der Maschine eingebaut werden sollen. Die gesamte Maschine, die mit diesen Komponenten ausgerüstet ist, muss den einschlägigen grundlegenden Sicherheits- und Gesundheitsanforderungen der vorgenannten Richtlinie entsprechen.</p> <p><b>Aufstellung</b>                      Vor der Aufstellung ist zu prüfen, dass die Antriebseinheit in Bezug auf die Betriebsbedingungen richtig ausgewählt wurde und die Einbaulage mit der Bestellung übereinstimmt. Angaben hierüber sind auf dem Typenschild zu finden. Die Stützkonstruktion für die Getriebe ist so stabil auszuführen, dass keine Schwingungen oder Überlastungen auftreten, eventuell sind elastische Kupplungen oder Drehmomentbegrenzer zu verwenden.</p> <p><b>Inbetriebnahme</b>                      Die Antriebseinheit kann in beiden Drehrichtungen eingesetzt werden. Die Einheit muss sofort angehalten werden, wenn ein unzulässiger Lauf oder unerwartete Geräusche auftreten. Das fehlerhafte Teil ist zu ersetzen oder die Einheit ist zur Überprüfung einzuschicken. Falls das fehlerhafte Teil nicht ersetzt wird, kann dies zu weiteren Schäden an anderen Bauteilen führen, was eine Feststellung der Ursachen sehr schwierig machen kann.</p> <p><b>Wartung</b>                      Obwohl die Einheiten vor der Auslieferung im Leerlauf getestet wurden, ist es ratsam sie in den ersten 20-30 Stunden nicht mit Volllast zu betreiben, um ein einwandfreies Einlaufen zu gewährleisten. Die Einheiten werden entsprechend den Angaben auf dem Typenschild mit synthetischem Schmierstoff Lebensdauer geschmiert ausgeliefert. Bei einem eventuellen Ölwechsel oder Nachfüllen darf der Schmierstoff nicht mit Mineralöl vermischt werden.</p> <p><b>Handhabung und Transport</b>                      Beim Heben und Transport ist auf stand sichere Lage und sorgfältige Befestigung geeigneter Hebe Vorrichtungen zu achten. Bewegliche Teile dürfen nicht zum Anheben benutzt werden.</p> <p><b>Anstrich</b>                      Beim Erneuern oder dem zusätzlichen Aufbringen eines Anstriches sind die Dichtungen, Kuppelungssitze und Wellen sorgfältig zu schützen.</p> <p><b>Langzeitlagerung</b>                      Die Einlagerung der Einheiten muss trocken und staubfrei erfolgen. Bei einer Einlagerungszeit über 3 Monate sind bearbeitete Flächen und Wellen mit Rostschutzmitteln zu besprühen. Dichtlippen sind mit Fett zu schützen.</p> <p><b>Entsorgung</b>                      In Übereinstimmung mit ISO 14001 weisen wir darauf hin, im Falle des Verschrottens die einzelnen Metallteile getrennt zu behandeln und Schmiermittel bei den befugten Stellen zu entsorgen. Verpackungen sollten soweit wie möglich wieder verwendet werden.</p>

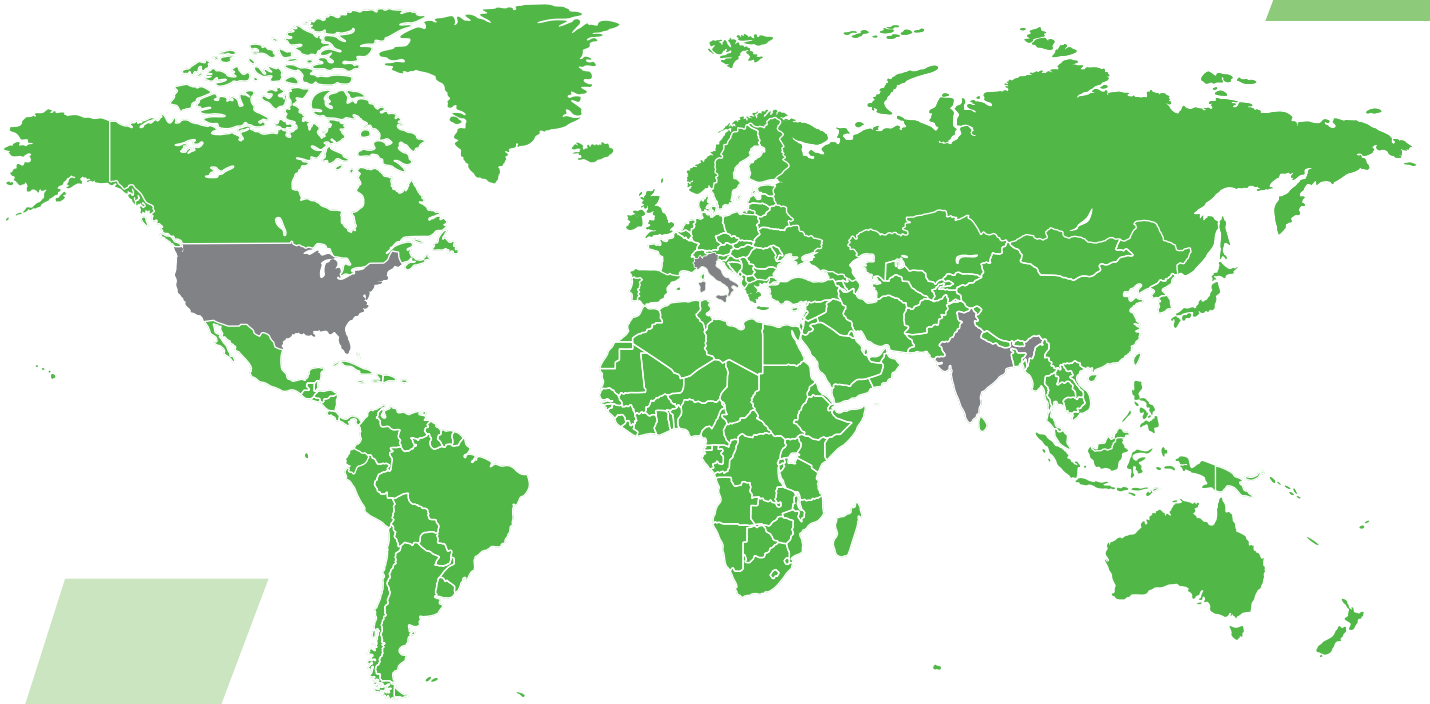

**2 Filiali estere in India e USA**  
Foreign subsidiaries, one in India, one in the USA  
Auslandsfilialen: in Indien und in den USA



**60 Oltre 60 anni di storia e successi internazionali**  
Over 60 years of history and international success  
Über 60 Jahre Unternehmensgeschichte und internationale



**100 Rete globale con oltre 100 partner commerciali**  
A global network with over 100 commercial partners  
Globales Vertriebsnetz mit mehr als 100 Handelspartnern

India subsidiary:  
**MGM-VARVEL Power Transmission Pvt Ltd**  
Warehouse N. G3 and G4 | Ground Floor  
Indus Valley's Logistic Park | Unit 3  
Mel Ayanambakkam Vellala Street  
Chennai - 600 095 | Tamil Nadu | INDIA  
info@mgmvarvelindia.com  
[www.mgmvarvelindia.com](http://www.mgmvarvelindia.com)

USA subsidiary:  
**VARVEL USA LLC**  
2815 Colonnades Court  
Peachtree Corners, GA 30071 | USA  
T 770-217-4567 | F 770-255-1978  
info@varvelusa.com  
[www.varvelusa.com](http://www.varvelusa.com)

