

Input data

System of measurement		Metric
Input type		Coupling for electric motor
Input speed	[rpm]	1400
Output speed	[rpm]	50
Ratio (i=)		28
Frequency	[Hz]	50
Input options		IEC
Requested input power	[kW]	0.55
Service factor		1.1
Rated Power P1	[kW]	0.63

Output data

Gear unit **F RT 50 B3 28 80 B14 AC 24**

Type		RT - Worm speed reducers
Input type		F (Elastic coupling)
Size		50
Ratio (i=)		28
Input flange		B14
Input speed	[rpm]	1400
Output speed	[rpm]	50
Rated output torque	[Nm]	74.58
Service Factor		1.1
Efficiency		0.71
Inertia moment	[kgm ²]	0.000048

Gear unit configuration

Output shaft		Hollow output shaft
Fixing		Universal
Version		B3

Output radial and axial loads

Ball bearings output radial load	[N]	2000
Taper bearings output radial load	[N]	3000
Ball bearings output axial load	[N]	400
Taper bearings output axial load	[N]	600

Accessories

Hollow output shaft		AC 24
---------------------	--	-------

Electric motor coupling

Size		80 A4
Poles n.		4
Power	[kW]	0.55

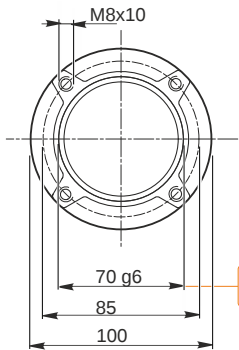
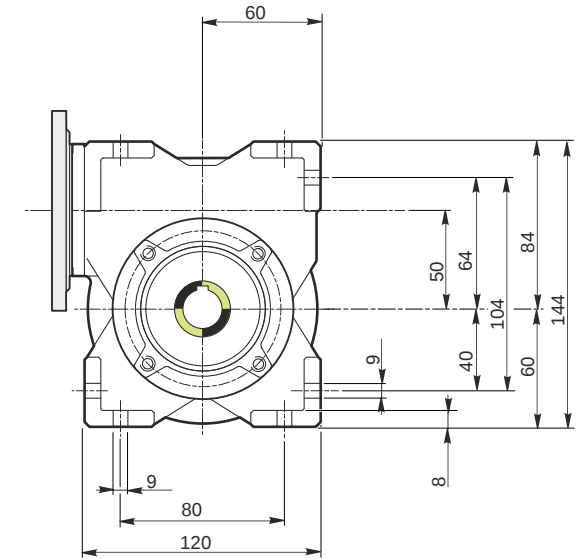
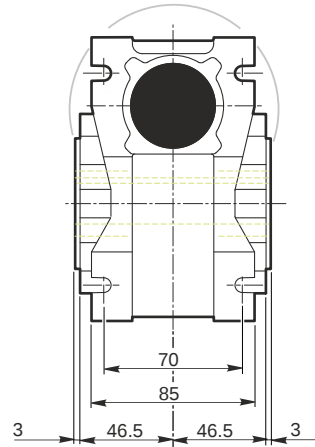
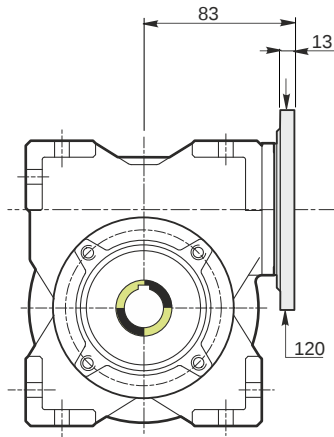

Hollow output shaft

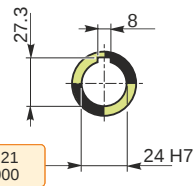

69.99
69.971

24.021
24.000

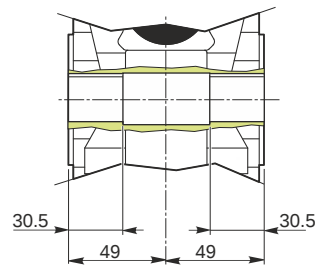

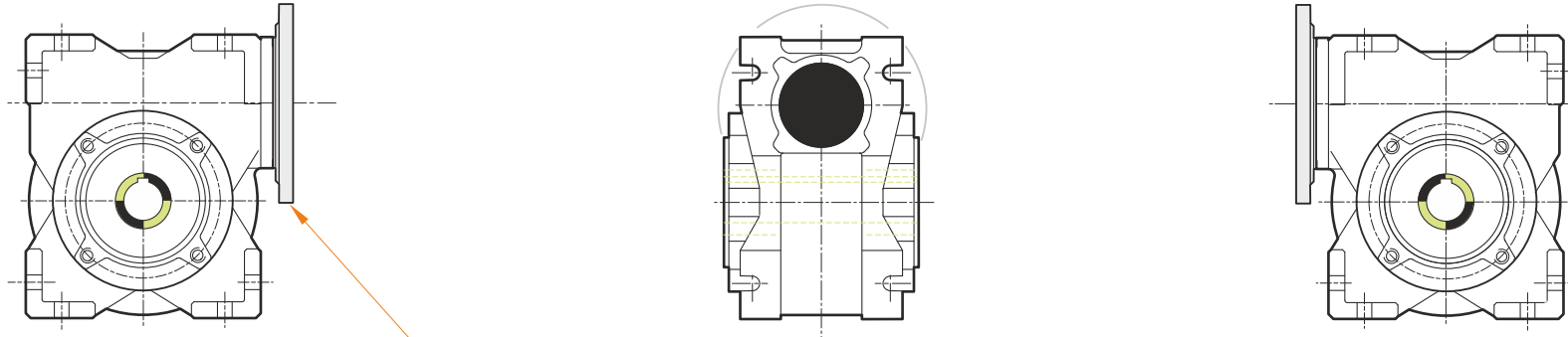

This gear unit is provided with an elastic coupling motor fitting

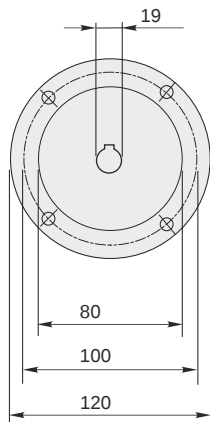

F RT 50 B3 28 80 B14 AC 24

Mounting positions

B3

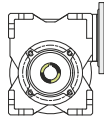

B6

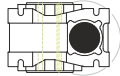

B7

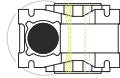

B8

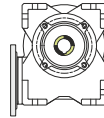

V5

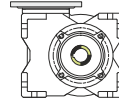

V6

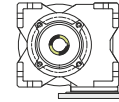

0.13



← Oil quantity [litres]

Lubricant type: Long life synthetic oil ISO VG320

Direction of rotation

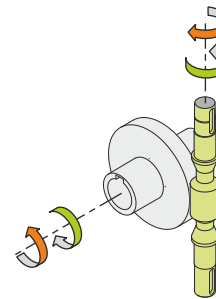
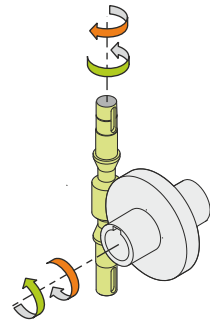
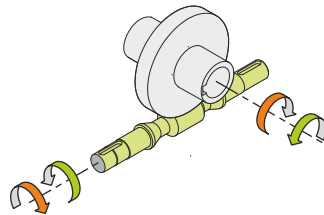

Weight

Gear unit [kg] 3.8

Gearing data

Axial module	2.7
Number of starts	1
Lead angle	6° 19'
Pressure angle	20°

Backdriving

Static self-locking
Slow back-driving in case of vibrations
Low dynamic back-driving