

Input data

System of measurement		Metric
Input type		Coupling for electric motor
Input speed	[rpm]	1400
Output speed	[rpm]	35
Ratio (i=)		40
Frequency	[Hz]	50
Input options		IEC
Requested input power	[kW]	0.09
Service factor		1.1
Rated Power P1	[kW]	0.1

Output data

Gear unit **F RT 28 B3 40 56 B14 AC 14**

Type		RT - Worm speed reducers
Input type		F (Elastic coupling)
Size		28
Ratio (i=)		40
Input flange		B14
Input speed	[rpm]	1400
Output speed	[rpm]	35
Rated output torque	[Nm]	15.23
Service Factor		1.1
Efficiency		0.62
Inertia moment	[kgm ²]	0.000005

Gear unit configuration

Output shaft		Hollow output shaft
Fixing		Universal
Version		B3

Output radial and axial loads

Ball bearings output radial load	[N]	700
Taper bearings output radial load	[N]	1050
Ball bearings output axial load	[N]	140
Taper bearings output axial load	[N]	210

Accessories

Hollow output shaft		AC 14
---------------------	--	-------

Electric motor coupling

Size		56 B4
Poles n.		4
Power	[kW]	0.09

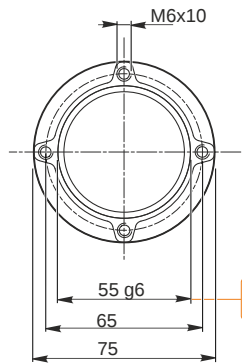
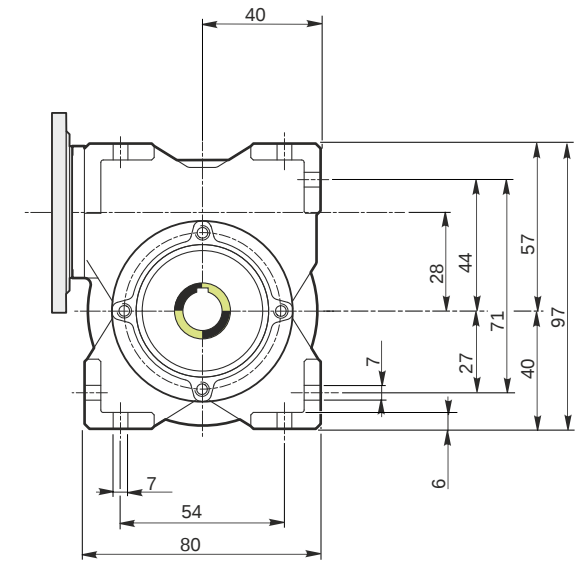
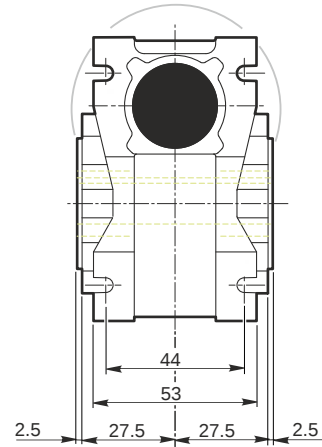
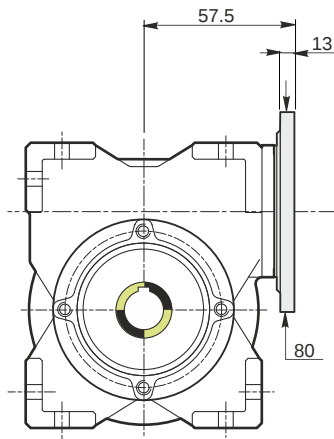

Hollow output shaft

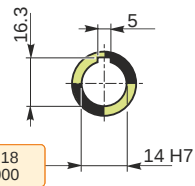

54.99
54.971

14.018
14.000

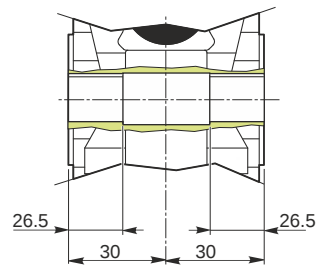

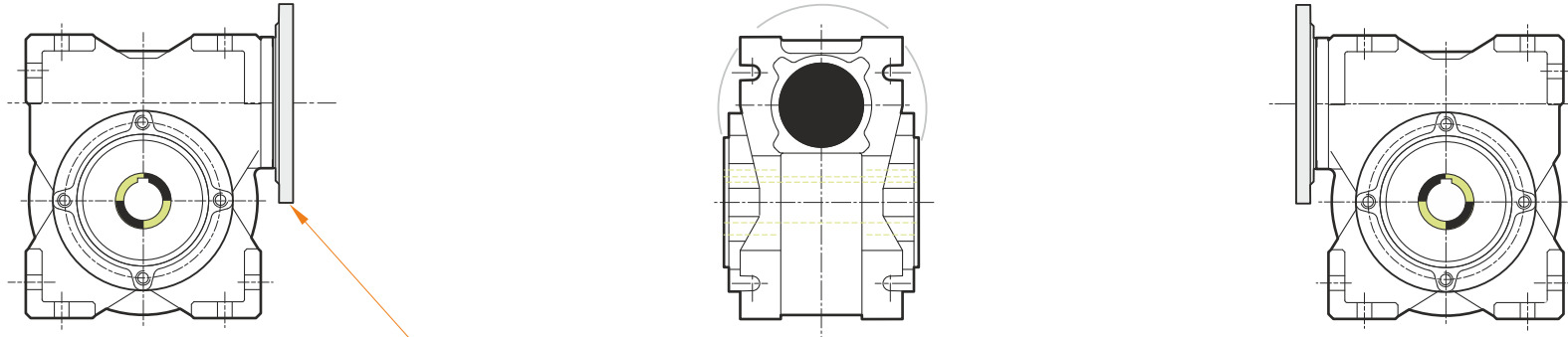

This gear unit is provided with an elastic coupling motor fitting

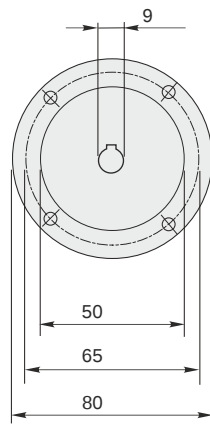

Mounting positions

B3

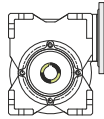

B6

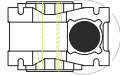

B7

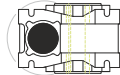

B8

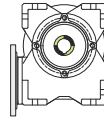

V5

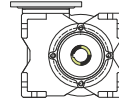

V6

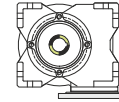

0.03



← Oil quantity [litres]

Lubricant type: Long life synthetic oil ISO VG320

Direction of rotation

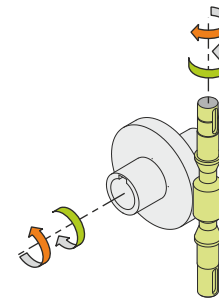
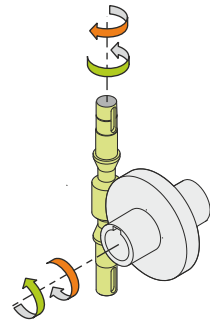
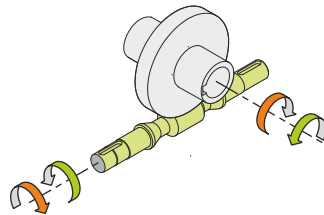

Weight

Gear unit [kg] 1.1

Gearing data

Axial module	1.1
Number of starts	1
Lead angle	5° 14'
Pressure angle	20°

Backdriving

Static self-locking
Slow back-driving in case of vibrations
Low dynamic back-driving