

### Input data

System of measurement		Metric
Input type		Coupling for electric motor
Input speed	[rpm]	1400
Output speed	[rpm]	14
Ratio (i=)		100
Frequency	[Hz]	50
Input options		IEC
Requested input power	[kW]	0.37
Service factor		1
Rated Power P1	[kW]	0.37

### Output data

<b>Gear unit</b>	<b>F RT 70 B3 100 71 B5 AC 28</b>
------------------	-----------------------------------

Type		RT - Worm speed reducers
Input type		F (Elastic coupling)
Size		70
Ratio (i=)		100
Input flange		B5
Input speed	[rpm]	1400
Output speed	[rpm]	14
Rated output torque	[Nm]	131.24
Service Factor		1
Efficiency		0.52
Inertia moment	[kgm <sup>2</sup> ]	0.000244

#### Gear unit configuration

Output shaft		Hollow output shaft
Fixing		Universal
Version		B3

#### Output radial and axial loads

Ball bearings output radial load	[N]	6700
Taper bearings output radial load	[N]	7900
Ball bearings output axial load	[N]	1340
Taper bearings output axial load	[N]	1580

#### Accessories

Hollow output shaft		AC 28
---------------------	--	-------

#### Electric motor coupling

Size		71 B4
Poles n.		4
Power	[kW]	0.37

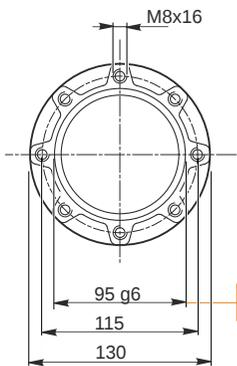
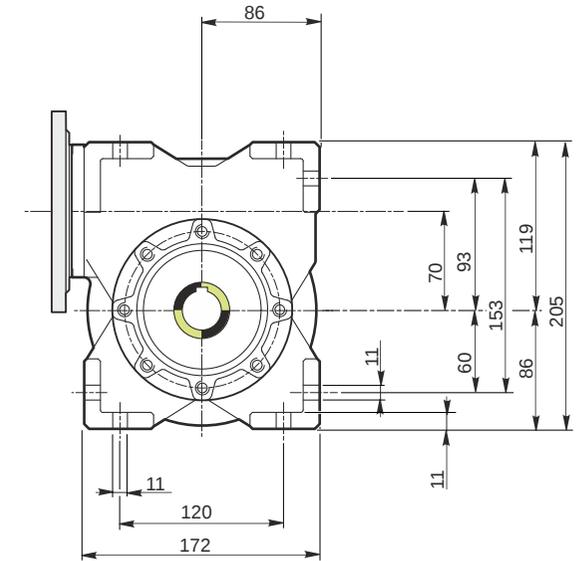
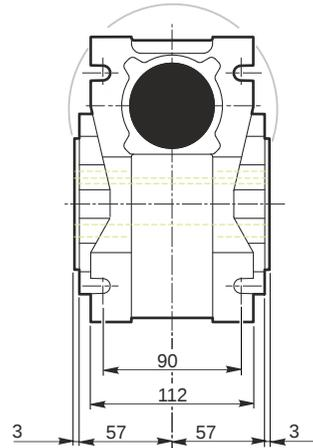
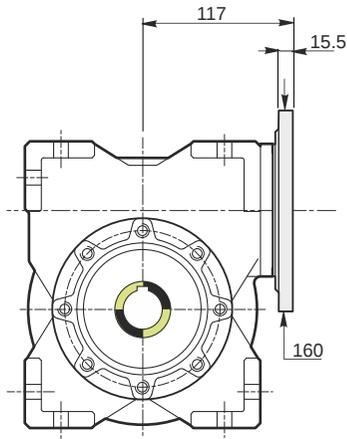

*Hollow output shaft*

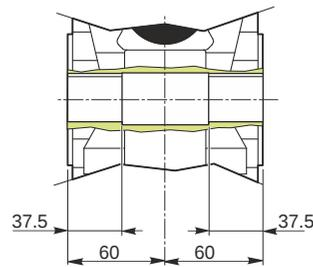
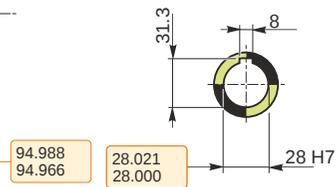

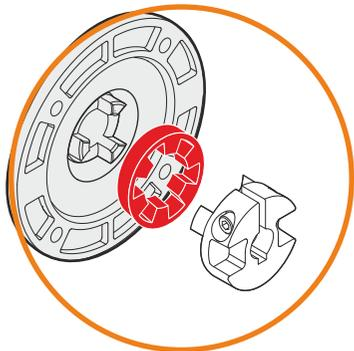
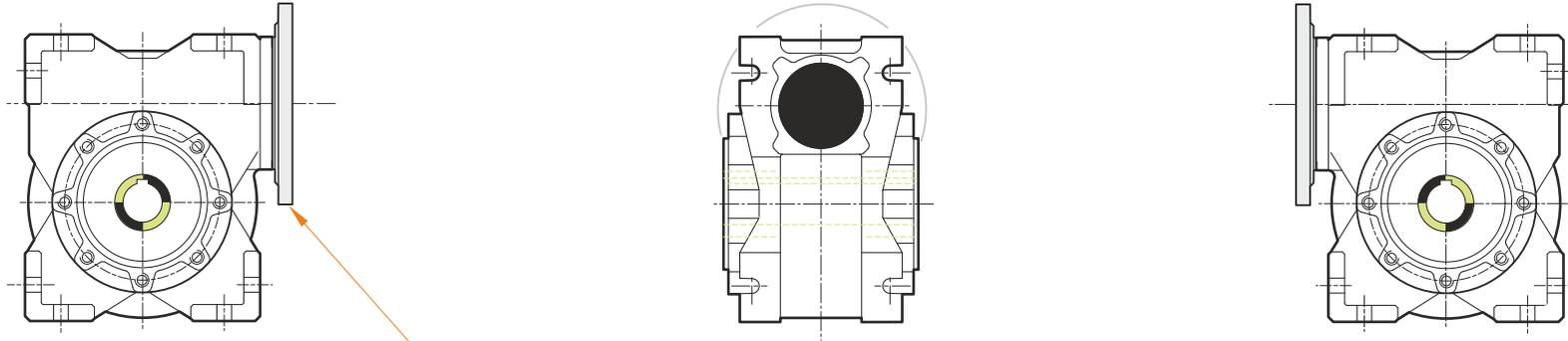

This gear unit is provided with an elastic coupling motor fitting

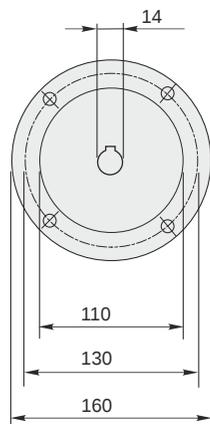

**F RT 70 B3 100 71 B5 AC 28**

**Mounting positions**

**B3**

**B6**

**B7**

**B8**

**V5**

**V6**

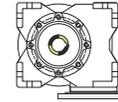
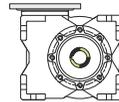
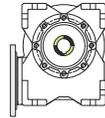
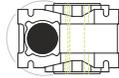
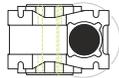
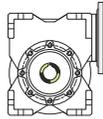

0.35



← Oil quantity [litres]

Lubricant type: Long life synthetic oil ISO VG320

**Direction of rotation**

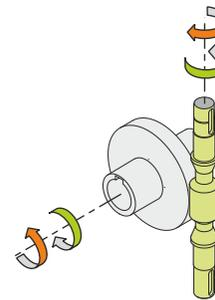
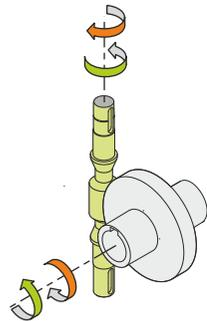
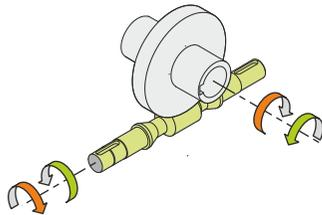
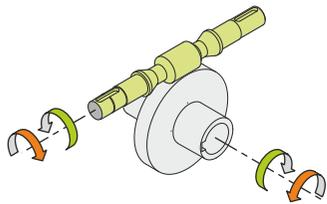

**Weight**

Gear unit [kg] 9

**Gearing data**

Axial module	1.15
Number of starts	1
Lead angle	2° 38'
Pressure angle	20°

**Backdriving**

Static self-locking  
No back-driving  
Low dynamic back-driving