

### Input data

System of measurement		Metric
Input type		Coupling for electric motor
Input speed	[rpm]	1400
Output speed	[rpm]	70
Ratio (i=)		20
Frequency	[Hz]	50
Input options		IEC
Requested input power	[kW]	4
Service factor		1.4
Rated Power P1	[kW]	5.71

### Output data

#### **Gear unit** F RT 110 B3 20 112 B14 AC 42

Type		RT - Worm speed reducers
Input type		F
Size		110
Ratio (i=)		20
Input flange		B14
Input speed	[rpm]	1400
Output speed	[rpm]	70
Rated output torque	[Nm]	452.94
Service Factor		1.4
Efficiency		0.83
Inertia moment	[kgm <sup>2</sup> ]	0.001745

#### **Gear unit configuration**

Output shaft		Hollow output shaft
Fixing		Universal
Version		B3

#### **Output radial and axial loads**

Ball bearings output radial load	[N]	5400
Taper bearings output radial load	[N]	7500
Ball bearings output axial load	[N]	1080
Taper bearings output axial load	[N]	1500

#### **Accessories**

Hollow output shaft		AC 42
---------------------	--	-------

#### **Electric motor coupling**

Size		112 A4
Poles n.		4
Power	[kW]	4

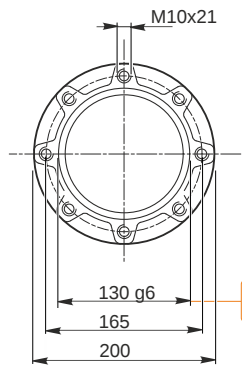
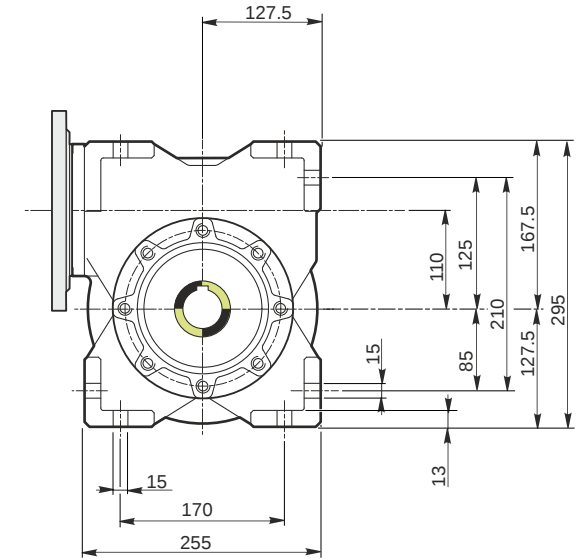
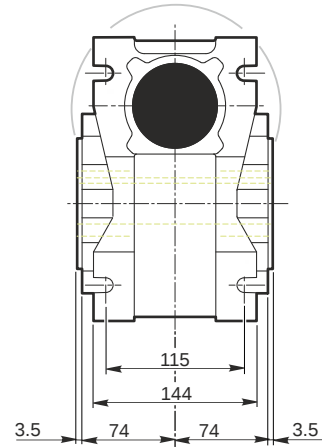
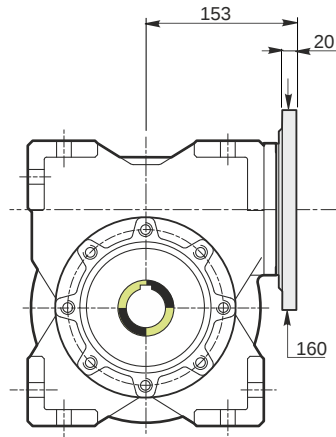

*Hollow output shaft*

129.986  
129.961

42.025  
42.000

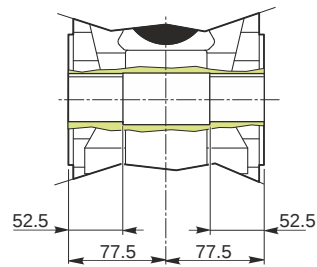
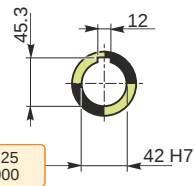

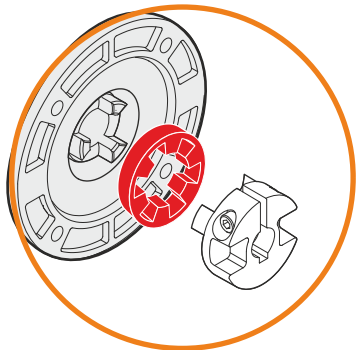
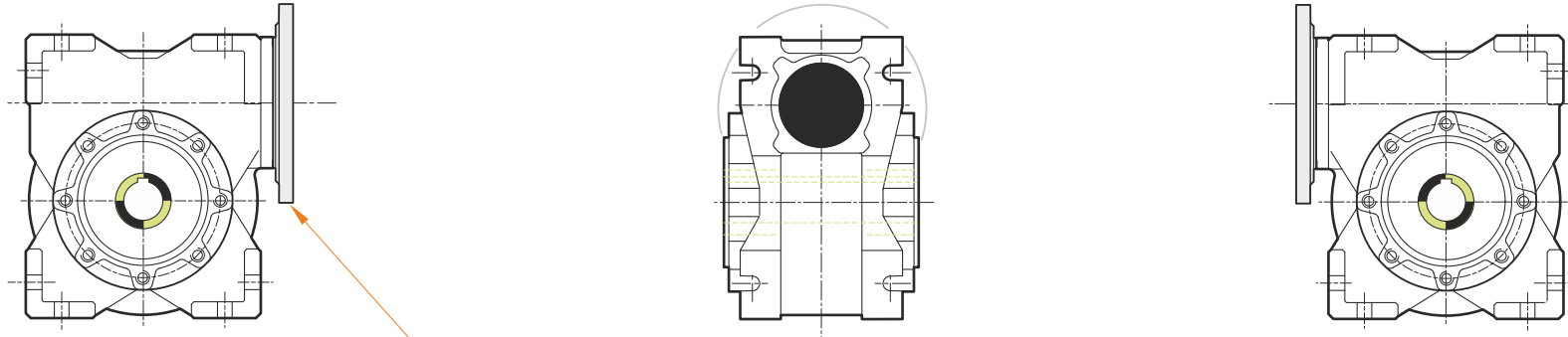

This gear unit is provided with an elastic coupling motor fitting

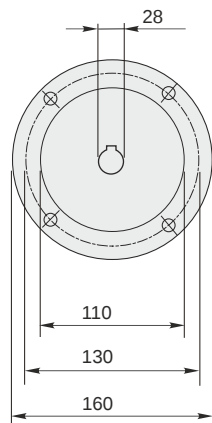

### Mounting positions

B3

B6

B7

B8

V5

V6

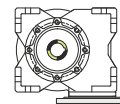
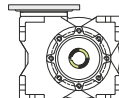
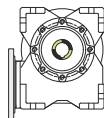
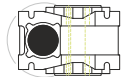
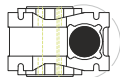
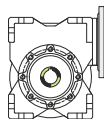

1.5



← Oil quantity [litres]

Lubricant type: Long life synthetic oil ISO VG320

### Direction of rotation

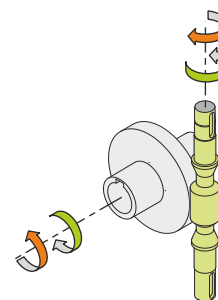
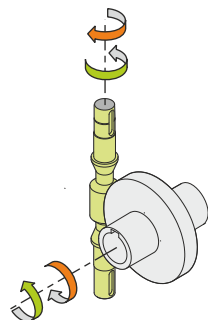
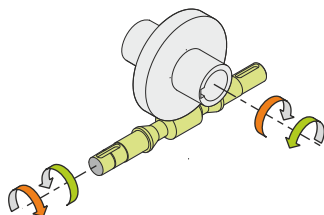
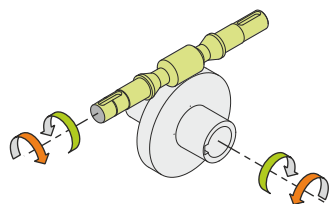

### Weight

Gear unit [kg] 39

### Gearing data

Axial module	4.4
Number of starts	2
Lead angle	11° 18'
Pressure angle	20°

### Backdriving

Variable static self-locking  
Quick back-driving in case of vibrations  
Dynamic back-driving