

Input data

System of measurement		Metric
Input type		Coupling for electric motor
Input speed	[rpm]	1400
Output speed	[rpm]	70
Ratio (i=)		20
Frequency	[Hz]	50
Input options		IEC
Requested input power	[kW]	0.55
Service factor		1.1
Rated Power P1	[kW]	0.63

Output data

Gear unit F RS 50 PC 20 80 B14 AC 24 B3

Type		RS - Worm speed reducers
Input type		F (Elastic coupling)
Size		50
Ratio (i=)		20
Input flange		B14
Mounting position		B3
Input speed	[rpm]	1400
Output speed	[rpm]	70
Rated output torque	[Nm]	57.03
Service Factor		1.1
Efficiency		0.76
Inertia moment	[kgm ²]	0.000049

Gear unit configuration

Output shaft		Hollow output shaft
Fixing		Shaft mounting
Version		PC

Output radial and axial loads

Ball bearings output radial load	[N]	1900
Taper bearings output radial load	[N]	2600
Ball bearings output axial load	[N]	380
Taper bearings output axial load	[N]	520

Accessories

Hollow output shaft		AC 24
---------------------	--	-------

Electric motor coupling

Size		80 A4
Poles n.		4
Power	[kW]	0.55

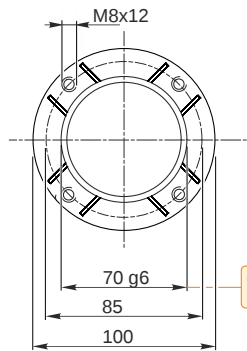
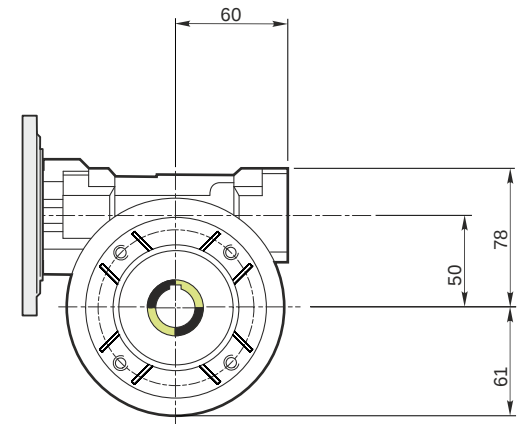
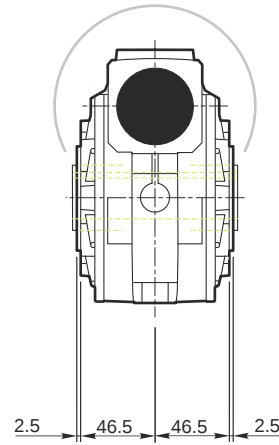
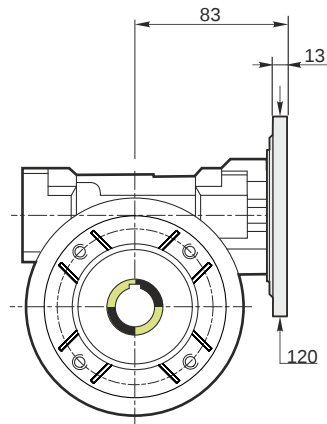

Hollow output shaft

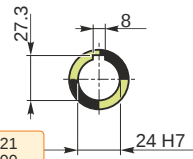

69.99
69.971

24.021
24.000

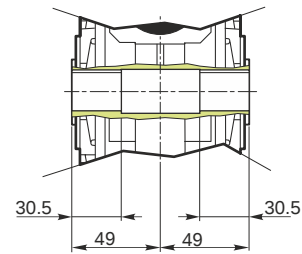

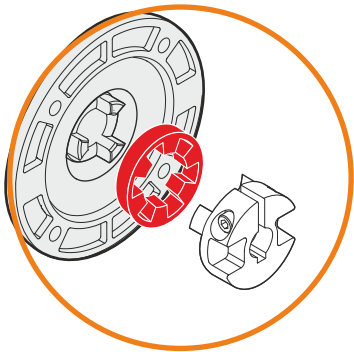
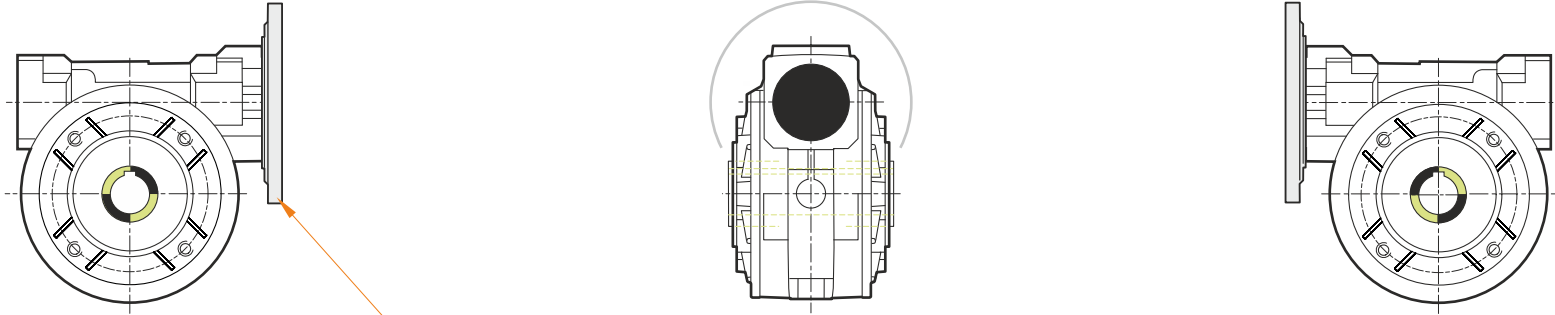

This gear unit is provided with an elastic coupling motor fitting

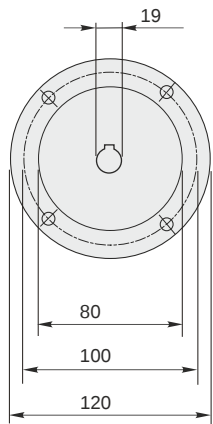

Mounting positions

B3

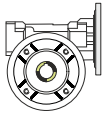

B6



B7



B8

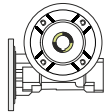

V5

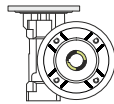

V6

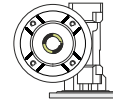

0.13



← Oil quantity [litres]

Lubricant type: Long life synthetic oil ISO VG320

Direction of rotation

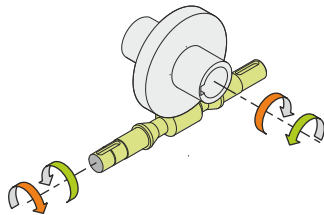

Weight

Gear unit [kg] 3.8

Gearing data

Axial module	1.9
Number of starts	2
Lead angle	8° 59'
Pressure angle	20°

Backdriving

Variable static self-locking
Quick back-driving in case of vibrations
Dynamic back-driving