

Input data

System of measurement		Metric
Input type		Coupling for electric motor
Input speed	[rpm]	1400
Output speed	[rpm]	25
Ratio (i=)		56
Frequency	[Hz]	50
Input options		IEC
Requested input power	[kW]	0.75
Service factor		1
Rated Power P1	[kW]	0.74

Output data

Gear unit F RS 70 PC 56 80 B14 AC 28 B3

Type		RS - Worm speed reducers
Input type		F (Elastic coupling)
Size		70
Ratio (i=)		56
Input flange		B14
Mounting position		B3
Input speed	[rpm]	1400
Output speed	[rpm]	25
Rated output torque	[Nm]	183.36
Service Factor		1
Efficiency		0.64
Inertia moment	[kgm ²]	0.000244

Gear unit configuration

Output shaft		Hollow output shaft
Fixing		Shaft mounting
Version		PC

Output radial and axial loads

Ball bearings output radial load	[N]	5500
Taper bearings output radial load	[N]	7300
Ball bearings output axial load	[N]	1100
Taper bearings output axial load	[N]	1460

Accessories

Hollow output shaft		AC 28
---------------------	--	-------

Electric motor coupling

Size		80 B4
Poles n.		4
Power	[kW]	0.75

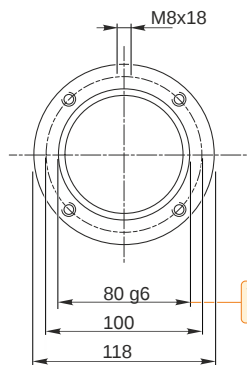
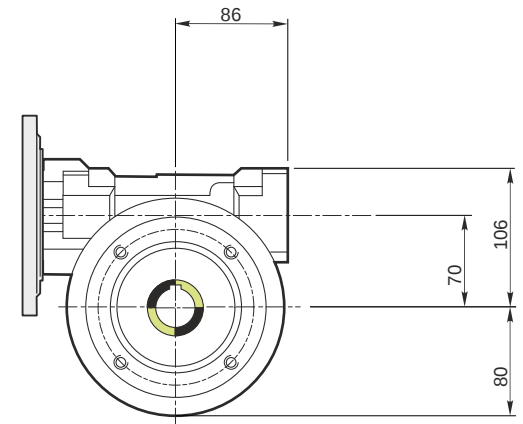
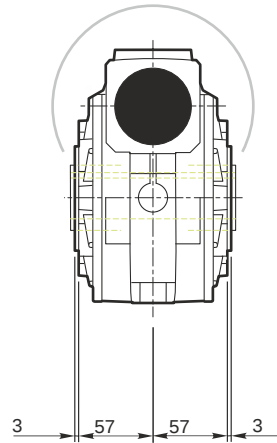
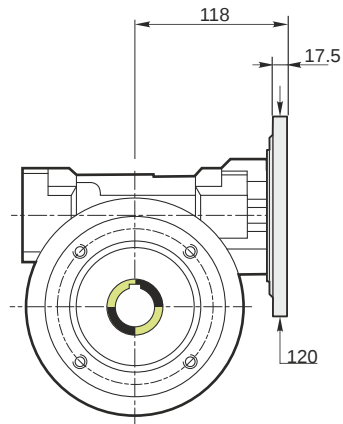

Hollow output shaft

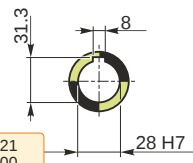

79.99
79.971

28.021
28.000

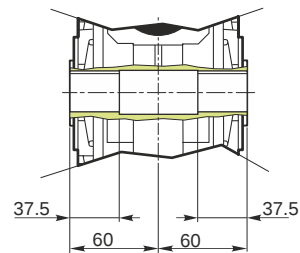

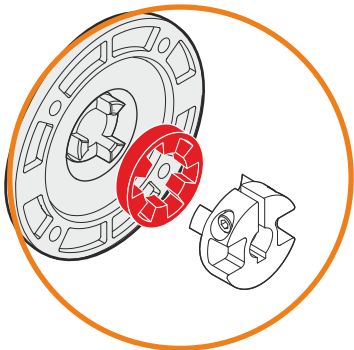
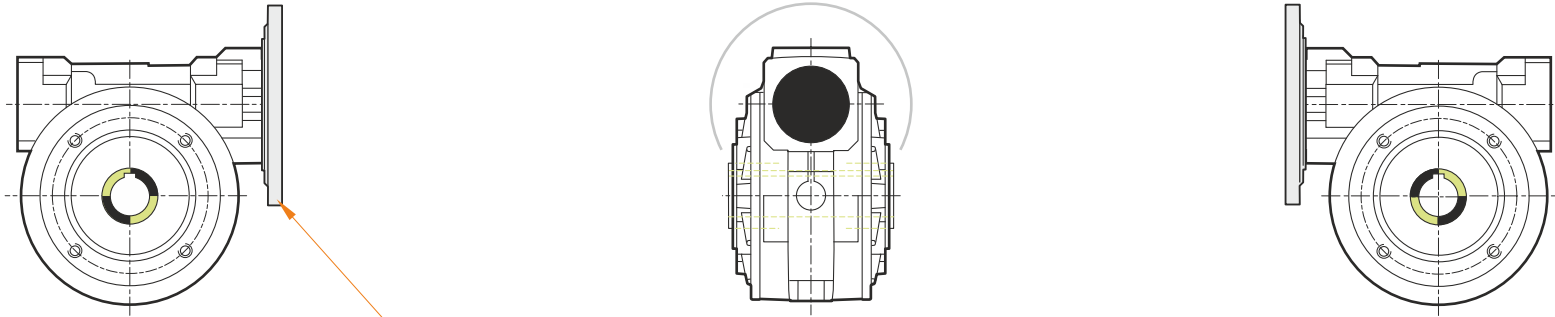

This gear unit is provided with an elastic coupling motor fitting

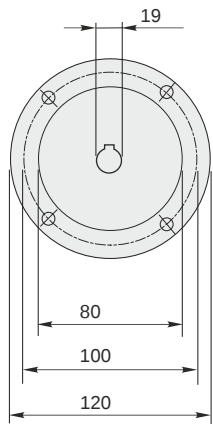

Mounting positions

B3

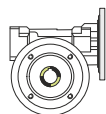

B6

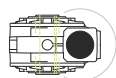

B7

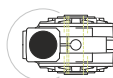

B8

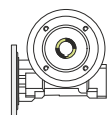

V5

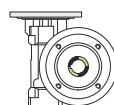

V6

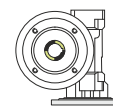

0.35



← Oil quantity [litres]

Lubricant type: Long life synthetic oil ISO VG320

Direction of rotation

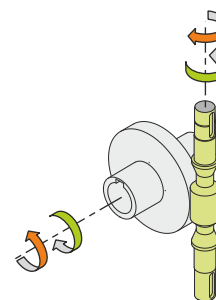
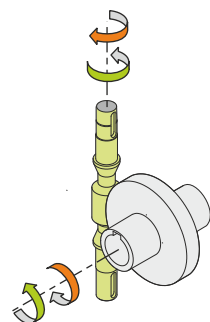
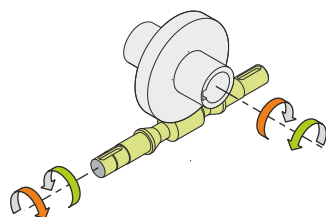
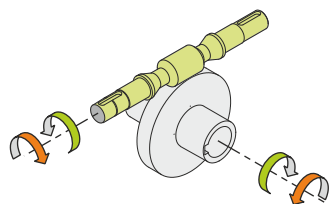

Weight

Gear unit [kg] 9

Gearing data

Axial module	2
Number of starts	1
Lead angle	4° 05'
Pressure angle	20°

Backdriving

Static self-locking
Slow back-driving in case of vibrations
Low dynamic back-driving