

Input data

| | | |
|-----------------------|-------|-----------------------------|
| System of measurement | | Metric |
| Input type | | Coupling for electric motor |
| Input speed | [rpm] | 1400 |
| Output speed | [rpm] | 140 |
| Ratio (i=) | | 10 |
| Frequency | [Hz] | 50 |
| Input options | | IEC |
| Requested input power | [kW] | 4 |
| Service factor | | 1.1 |
| Rated Power P1 | [kW] | 4.57 |

Output data

Gear unit F RS 85 PC 10 112 B14 AC 32 B3

| | | |
|---------------------|---------------------|--------------------------|
| Type | | RS - Worm speed reducers |
| Input type | | F (Elastic coupling) |
| Size | | 85 |
| Ratio (i=) | | 10 |
| Input flange | | B14 |
| Mounting position | | B3 |
| Input speed | [rpm] | 1400 |
| Output speed | [rpm] | 140 |
| Rated output torque | [Nm] | 234.66 |
| Service Factor | | 1.1 |
| Efficiency | | 0.86 |
| Inertia moment | [kgm ²] | 0.000413 |

Gear unit configuration

| | | |
|--------------|--|---------------------|
| Output shaft | | Hollow output shaft |
| Fixing | | Shaft mounting |
| Version | | PC |

Output radial and axial loads

| | | |
|-----------------------------------|-----|------|
| Ball bearings output radial load | [N] | 3700 |
| Taper bearings output radial load | [N] | 4600 |
| Ball bearings output axial load | [N] | 740 |
| Taper bearings output axial load | [N] | 920 |

Accessories

| | | |
|---------------------|--|-------|
| Hollow output shaft | | AC 32 |
|---------------------|--|-------|

Electric motor coupling

| | | |
|----------|------|--------|
| Size | | 112 A4 |
| Poles n. | | 4 |
| Power | [kW] | 4 |

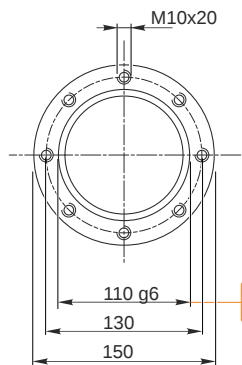
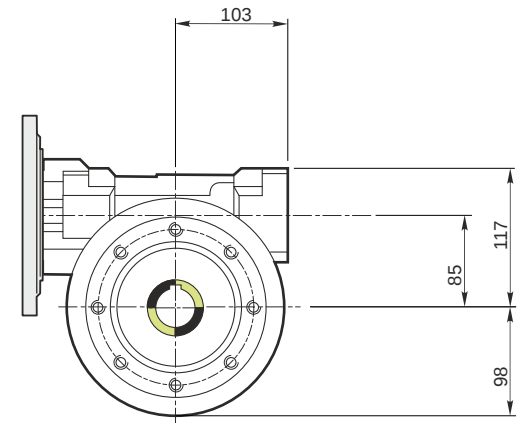
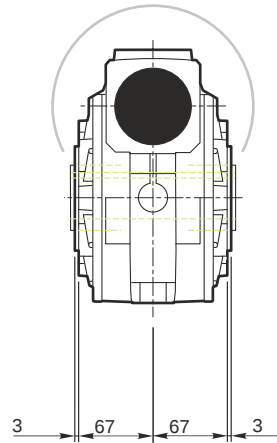
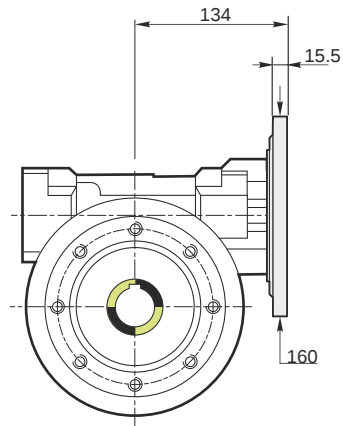

Hollow output shaft

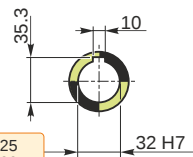

109.988
109.966

32.025
32.000

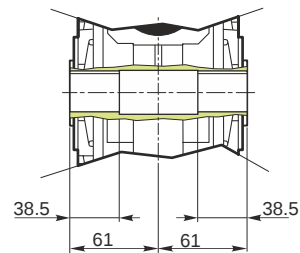

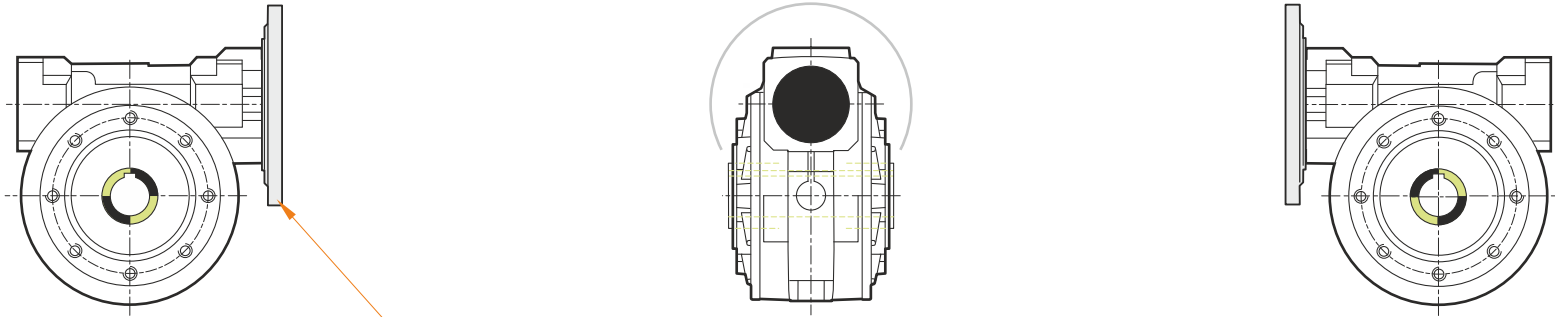

This gear unit is provided with an elastic coupling motor fitting

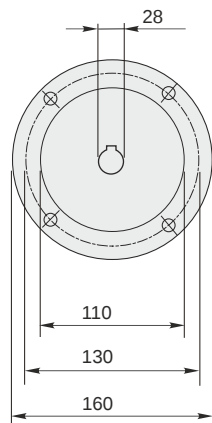

Mounting positions

B3

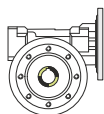

B6

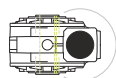

B7

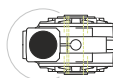

B8

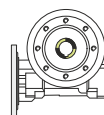

V5

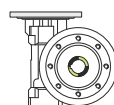

V6

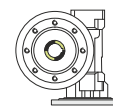

0.6



← Oil quantity [litres]

Lubricant type: Long life synthetic oil ISO VG320

Direction of rotation

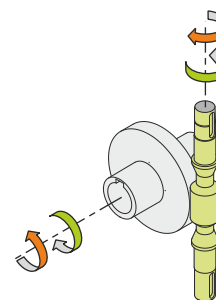
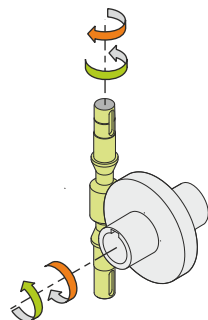
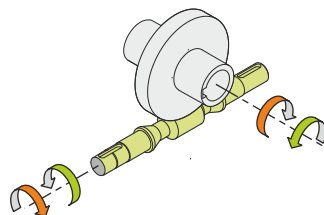
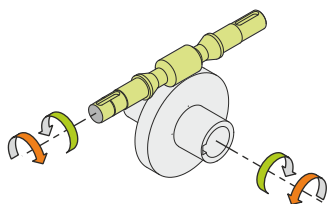

Weight

Gear unit [kg] 13.5

Gearing data

| | |
|------------------|---------|
| Axial module | 4.4 |
| Number of starts | 3 |
| Lead angle | 19° 09' |
| Pressure angle | 20° |

Backdriving

Static back-driving
Quick back-driving
Dynamic back-driving