

Input data

System of measurement		Metric
Input type		Coupling for electric motor
Input speed	[rpm]	1400
Output speed	[rpm]	20
Ratio (i=)		70
Frequency	[Hz]	50
Input options		IEC
Requested input power	[kW]	0.75
Service factor		1.3
Rated Power P1	[kW]	0.96

Output data

Gear unit F RS 85 PC 70 80 B14 AC 32 B3

Type		RS - Worm speed reducers
Input type		F (Elastic coupling)
Size		85
Ratio (i=)		70
Input flange		B14
Mounting position		B3
Input speed	[rpm]	1400
Output speed	[rpm]	20
Rated output torque	[Nm]	225.62
Service Factor		1.3
Efficiency		0.63
Inertia moment	[kgm ²]	0.00034

Gear unit configuration

Output shaft		Hollow output shaft
Fixing		Shaft mounting
Version		PC

Output radial and axial loads

Ball bearings output radial load	[N]	7100
Taper bearings output radial load	[N]	9400
Ball bearings output axial load	[N]	1420
Taper bearings output axial load	[N]	1880

Accessories

Hollow output shaft		AC 32
---------------------	--	-------

Electric motor coupling

Size		80 B4
Poles n.		4
Power	[kW]	0.75

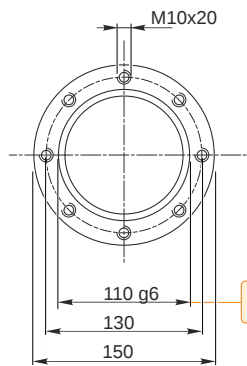
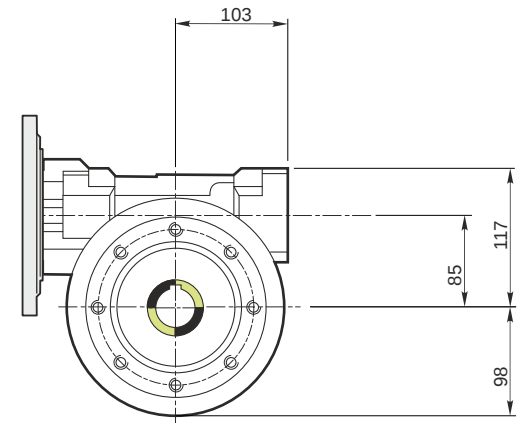
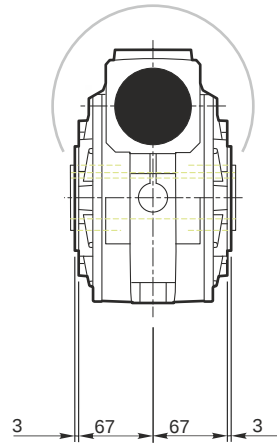
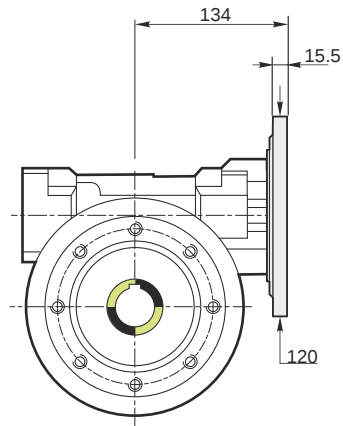

Hollow output shaft

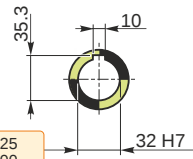

109.988
109.966

32.025
32.000

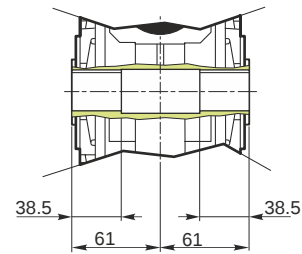

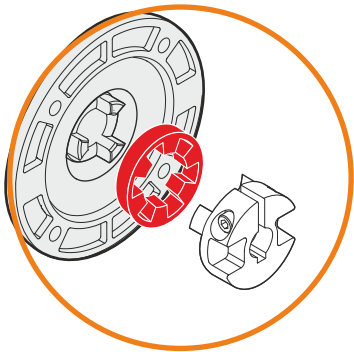
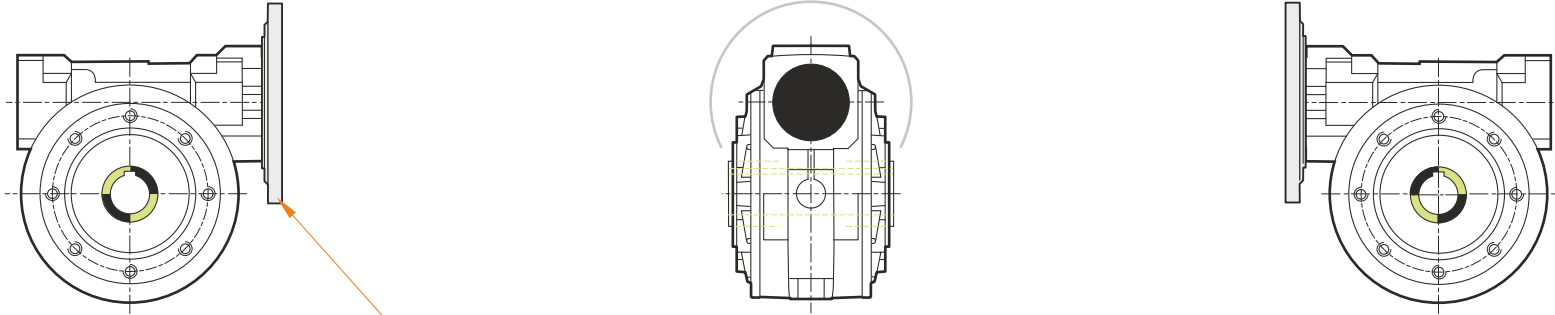

This gear unit is provided with an elastic coupling motor fitting

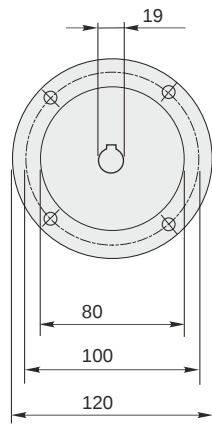

Mounting positions

B3

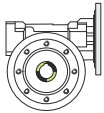

B6



B7



B8

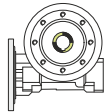

V5

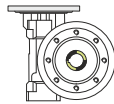

V6

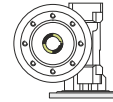

0.6



← Oil quantity [litres]

Lubricant type: Long life synthetic oil ISO VG320

Direction of rotation

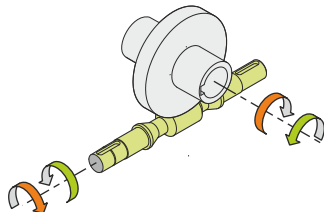

Weight

Gear unit [kg] 13.5

Gearing data

Axial module	2
Number of starts	1
Lead angle	3° 48'
Pressure angle	20°

Backdriving

Static self-locking
Slow back-driving in case of vibrations
Low dynamic back-driving