

Input data

System of measurement		Metric
Input type		Coupling for electric motor
Input speed	[rpm]	1400
Output speed	[rpm]	17.5
Ratio (i=)		80
Frequency	[Hz]	50
Input options		IEC
Requested input power	[kW]	1.5
Service factor		1
Rated Power P1	[kW]	1.46

Output data

Gear unit F RS 110 PC 80 90 B14 AC 42 B3

Type		RS - Worm speed reducers
Input type		F
Size		110
Ratio (i=)		80
Input flange		B14
Mounting position		B3
Input speed	[rpm]	1400
Output speed	[rpm]	17.5
Rated output torque	[Nm]	540.26
Service Factor		1
Efficiency		0.66
Inertia moment	[kgm ²]	0.001684

Gear unit configuration

Output shaft		Hollow output shaft
Fixing		Shaft mounting
Version		PC

Output radial and axial loads

Ball bearings output radial load	[N]	8800
Taper bearings output radial load	[N]	11100
Ball bearings output axial load	[N]	1760
Taper bearings output axial load	[N]	2220

Accessories

Hollow output shaft		AC 42
---------------------	--	-------

Electric motor coupling

Size		90 L4
Poles n.		4
Power	[kW]	1.5

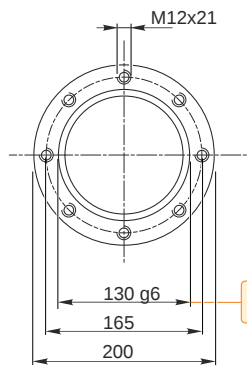
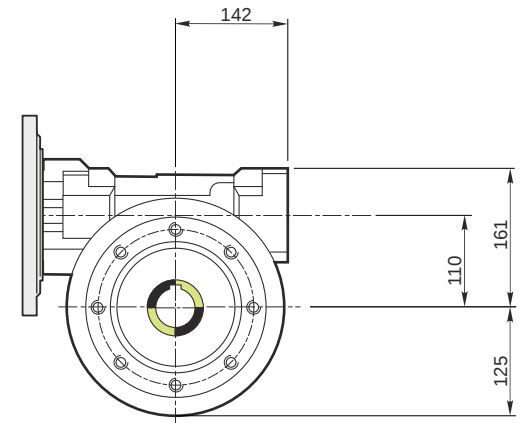
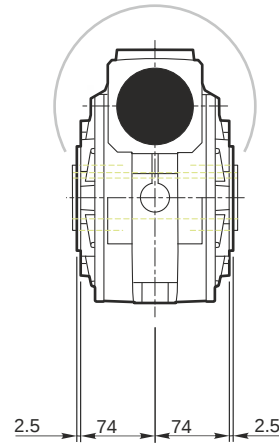
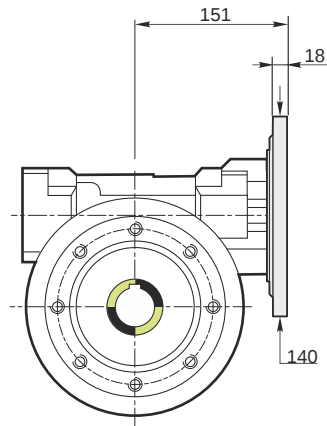

Hollow output shaft

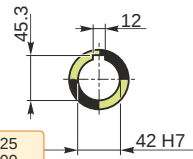

129.986
129.961

42.025
42.000

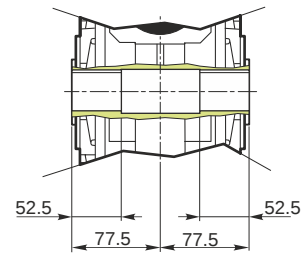

F RS 110 PC 80 90 B14 AC 42 B3

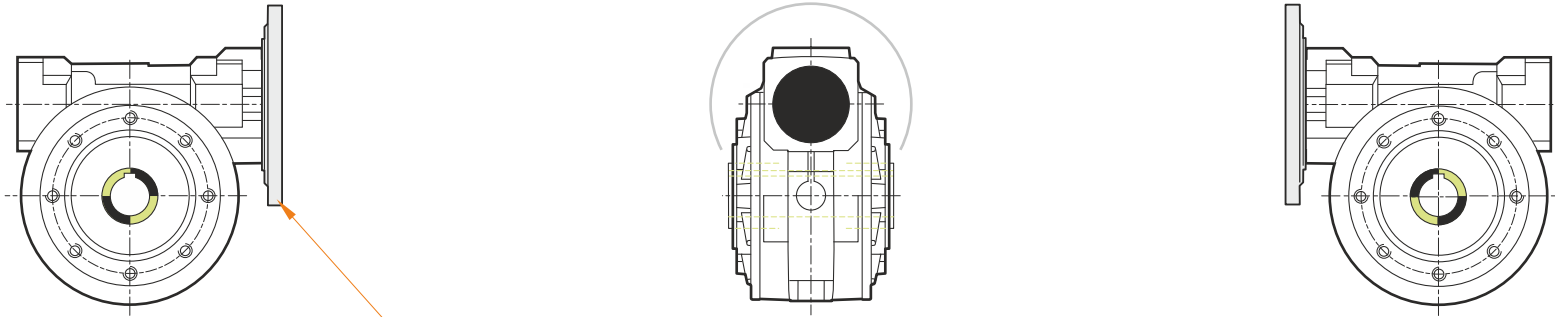

This gear unit is provided with an elastic coupling motor fitting

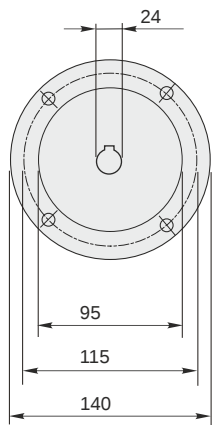

Mounting positions

B3

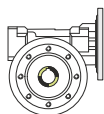

B6

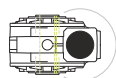

B7

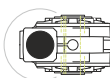

B8

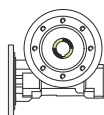

V5

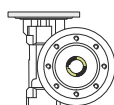

V6

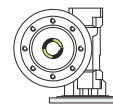

1.5



← Oil quantity [litres]

Lubricant type: Long life synthetic oil ISO VG320

Direction of rotation

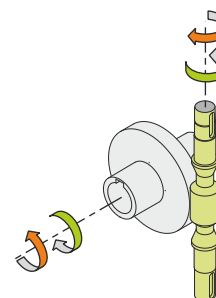
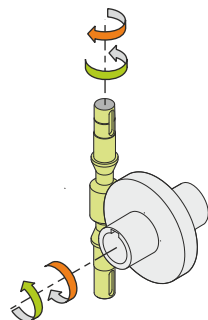
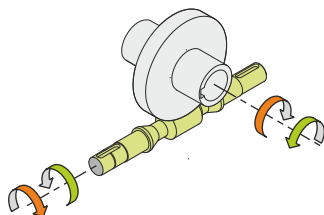
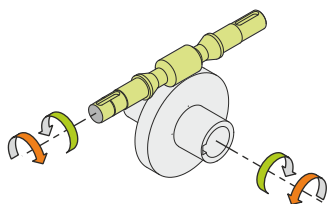

Weight

Gear unit [kg] 39

Gearing data

Axial module	2.3
Number of starts	1
Lead angle	3° 39'
Pressure angle	20°

Backdriving

Static self-locking
Slow back-driving in case of vibrations
Low dynamic back-driving