

Input data

System of measurement		Metric
Input type		Gear motor
Input speed	[rpm]	1400
Output speed	[rpm]	3.33
Ratio (i=)		420
Frequency	[Hz]	50
Input options		IEC
Requested input power	[kW]	0.75
Service factor		1.2
Rated Power P1	[kW]	0.87

Output data

Gear unit	M RT/RT 50/110 B3 21 420 80 B14 AC 42 MT 0.75 kW 80 B4 B14 X3
------------------	--

Type		RT/RT - Worm speed reducers
Input type		M
Size		50/110
Ratio (i=)		420
Gearbox ratio		28.00
Pre-stage ratio		15.00
Input flange		B14
Input speed	[rpm]	1400
Output speed	[rpm]	3.33
Rated output torque	[Nm]	1031.4
Service Factor		1.2
Efficiency		0.48

Gear unit configuration

Output shaft		Hollow output shaft
Fixing		Universal
Version		B3
Attachment position		21

Output radial and axial loads

Ball bearings output radial load	[N]	9800
Taper bearings output radial load	[N]	11100
Ball bearings output axial load	[N]	1960
Taper bearings output axial load	[N]	2220

Accessories

Hollow output shaft		AC 42
---------------------	--	-------

Electric motor

Size		80 B4
Poles		4
Power	[kW]	0.75

Electric motor configuration

Motor flange		B14
Terminal box position		X3

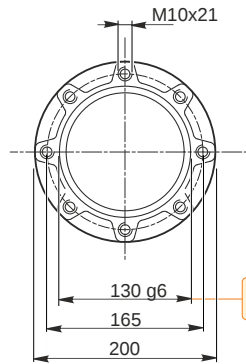
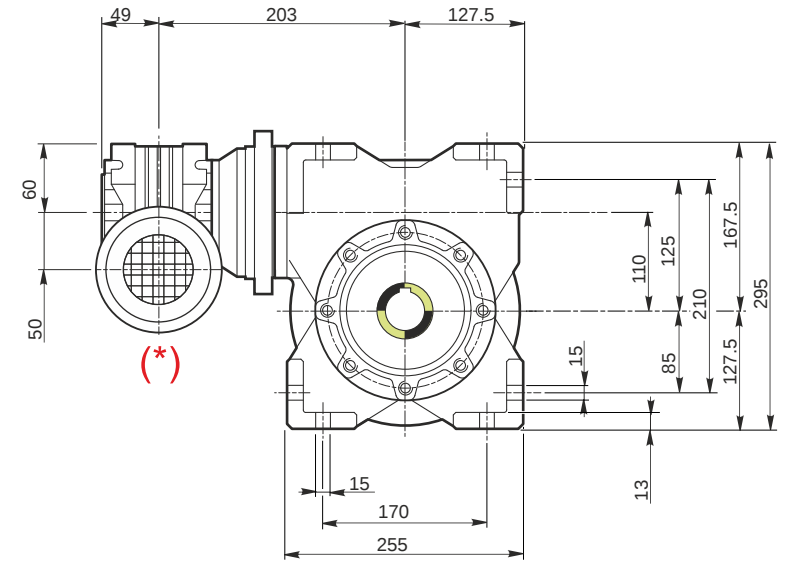
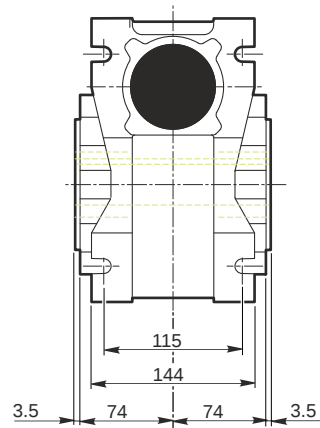
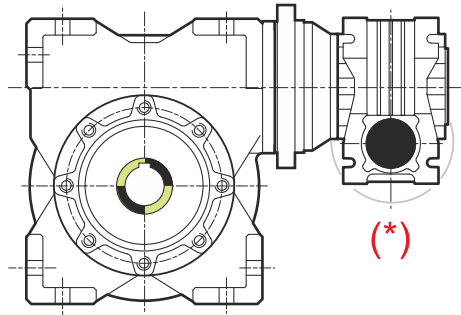

129.986
129.961

Hollow output shaft

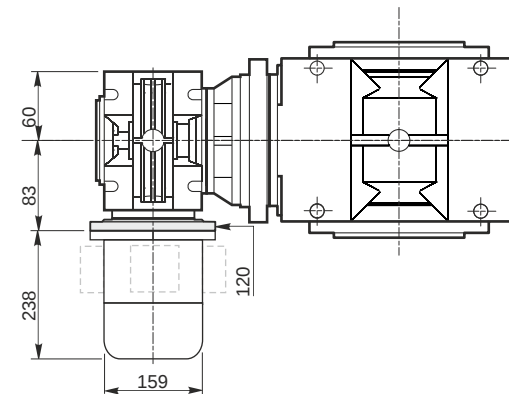
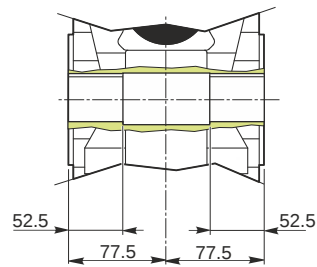
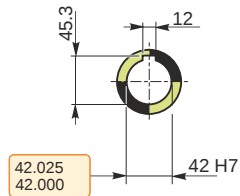

Mounting positions

B3

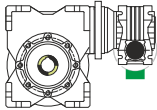

B6

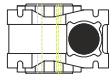

B7

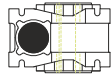

B8

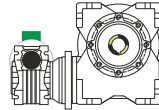

V5

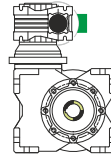

V6

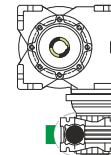

Terminal box position

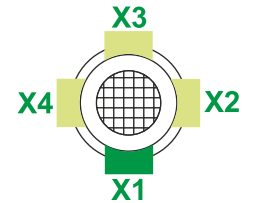

0.13

1



← Oil quantity [litres]

1.5

2

Lubricant type: Long life synthetic oil ISO VG320

Attachment position

20
(std)

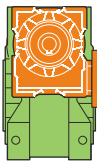
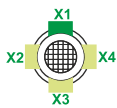

26

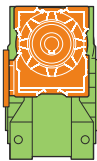
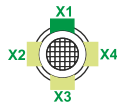

21

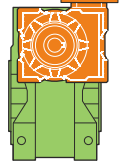
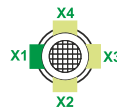

25

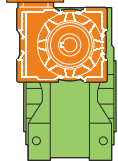
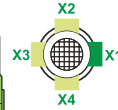

22

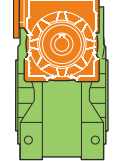
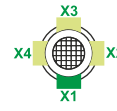

24

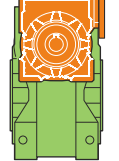

23

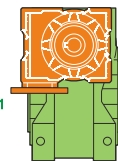
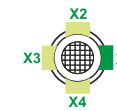

27

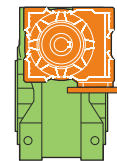
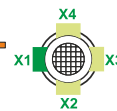

Direction of rotation

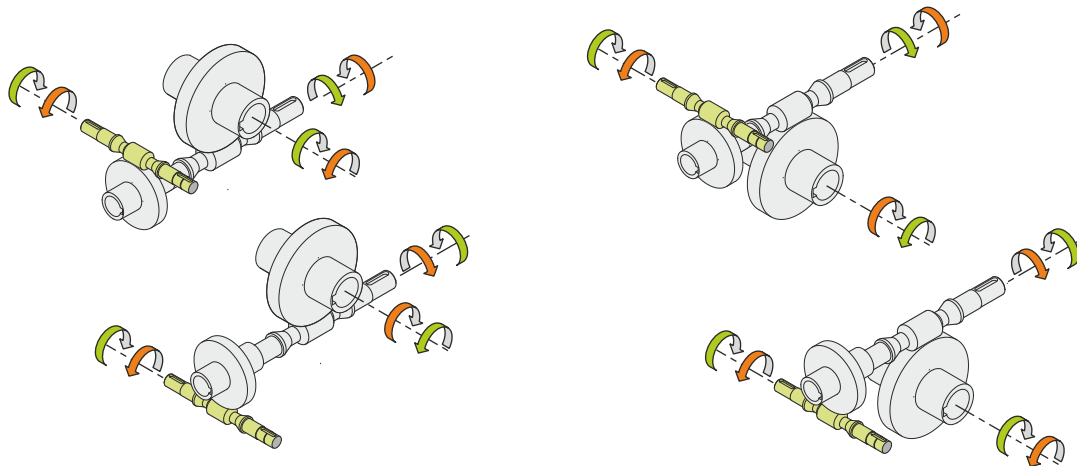

Weight

Gear unit [kg]	45
Electric motor [kg]	9.8

Gearing data

Axial module	6.1
Number of starts	1
Lead angle	7° 04'
Pressure angle	20°

Backdriving

Static self-locking
Slow back-driving in case of vibrations
Low dynamic back-driving

M RT/RT 50/110 B3 21 420 80 B14 AC 42 MT 0.75 kW 80 B4 B14 X3