

Input data

System of measurement		Metric
Input type		Gear motor
Input speed	[rpm]	1400
Output speed	[rpm]	1.79
Ratio (i=)		784
Frequency	[Hz]	50
Input options		IEC
Requested input power	[kW]	0.09
Service factor		0.8
Rated Power P1	[kW]	0.07

Output data

Gear unit **M RS/RS 28/60 S (bolted) 11 784 56 B14 AC 25 MT 0.09 kW 56 B4 B14 X3 B3**

Type		RS/RS - Worm speed reducers
Input type		M
Size		28/60
Ratio (i=)		784
Gearbox ratio		28.00
Pre-stage ratio		28.00
Input flange		B14
Mounting position		B3
Input speed	[rpm]	1400
Output speed	[rpm]	1.79
Rated output torque	[Nm]	168.46
Service Factor		0.8
Efficiency		0.35

Gear unit configuration

Output shaft		Hollow output shaft
Fixing		Feet
Version		S (bolted)
Attachment position		11

Output radial and axial loads

Ball bearings output radial load	[N]	5600
Taper bearings output radial load	[N]	6600
Ball bearings output axial load	[N]	1120
Taper bearings output axial load	[N]	1320

Accessories

Hollow output shaft		AC 25
---------------------	--	-------

Electric motor

Size		56 B4
Poles		4
Power	[kW]	0.09

Electric motor configuration

Motor flange		B14
Terminal box position		X3

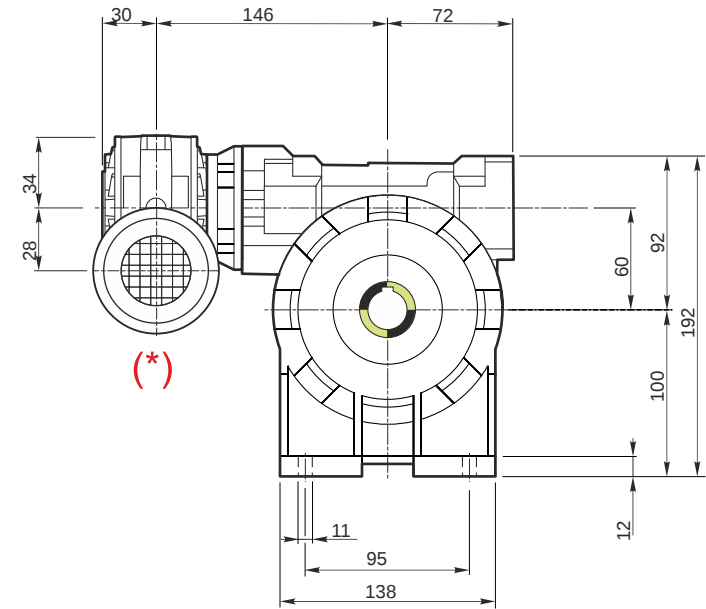
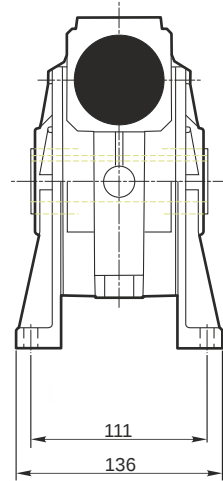

Hollow output shaft

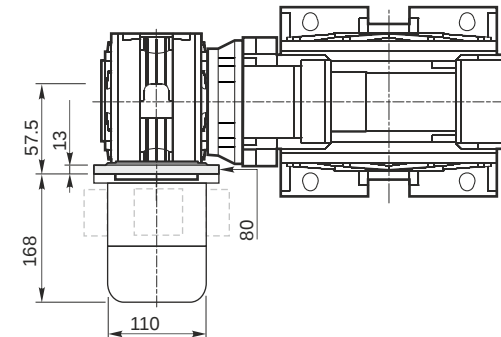
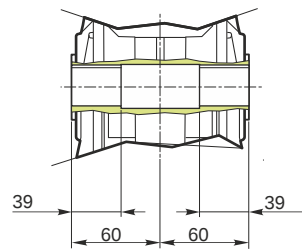
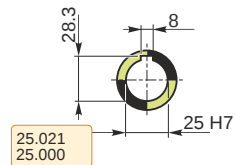

M RS/RS 28/60 S (bolted) 11 784 56 B14 AC 25 MT 0.09 kW 56 B4 B14 X3 B3

Mounting positions

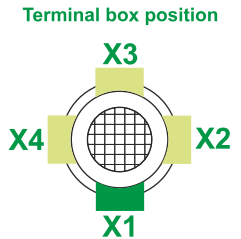
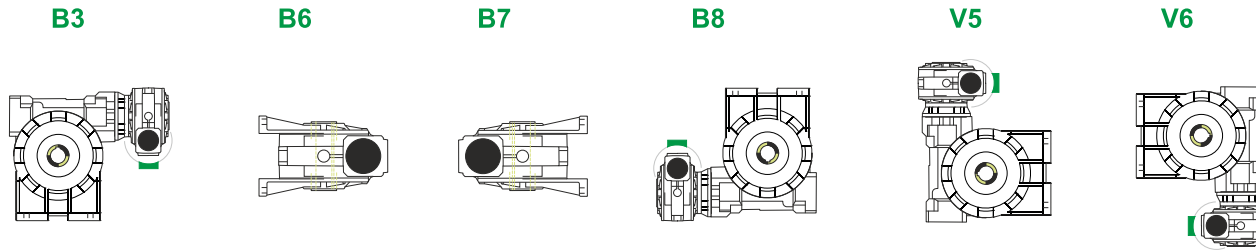

0.03	1
0.23	2



Lubricant type: Long life synthetic oil ISO VG320

Attachment position

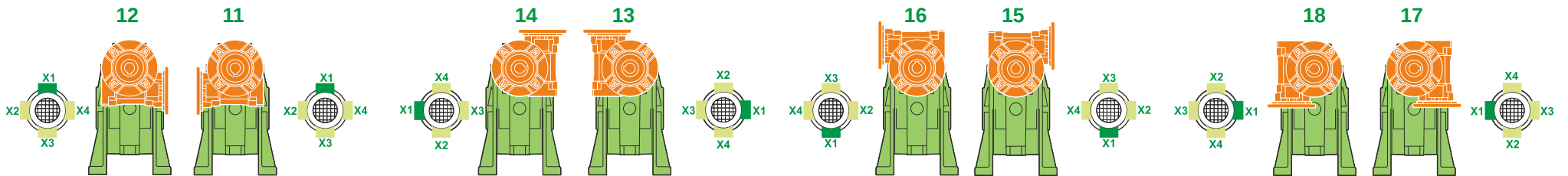

Direction of rotation

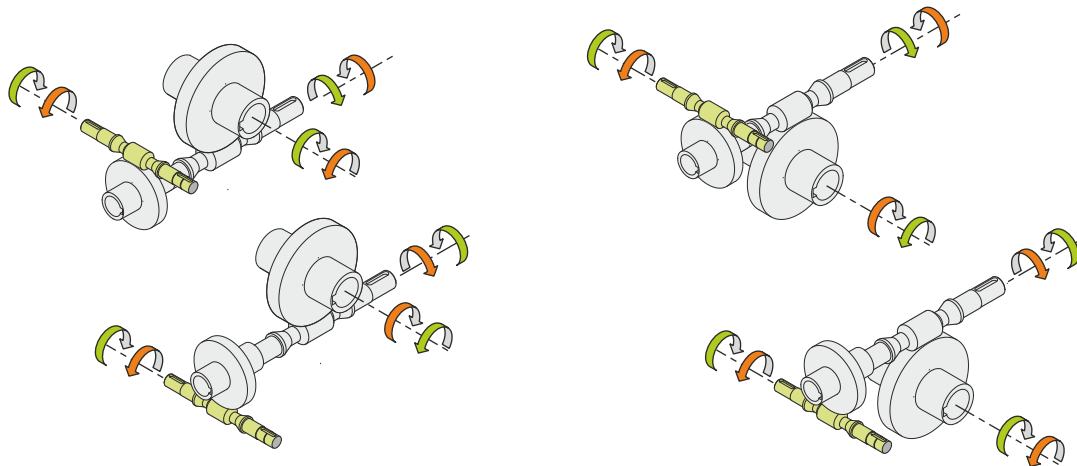

Weight

Gear unit [kg]	7.9
Electric motor [kg]	2.6

Gearing data 2

2	Axial module	3.3
	Number of starts	1
	Lead angle	6°49'
	Pressure angle	20°

Backdriving

- Static self-locking
- Slow back-driving in case of vibrations
- Low dynamic back-driving

M RS/RS 28/60 S (bolted) 11 784 56 B14 AC 25 MT 0.09 kW 56 B4 B14 X3 B3