

Input data

System of measurement		Metric
Input type		Gear motor
Input speed	[rpm]	1400
Output speed	[rpm]	31.25
Ratio (i=)		44.8
Frequency	[Hz]	50
Input options		IEC
Requested input power	[kW]	0.37
Service factor		1.6
Rated Power P1	[kW]	0.61

Output data

Gear unit **M TA 71/50 B3 10 44.8 71 B14 AC 24 MT 0.37 kW 71 B4 B14 X3**

Type		TA - Worm speed reducers
Input type		M
Size		71/50
Ratio (i=)		44.8
Gearbox ratio		7.00
Pre-stage ratio		6.40
Input flange		B14
Input speed	[rpm]	1400
Output speed	[rpm]	31.25
Rated output torque	[Nm]	88.2
Service Factor		1.6
Efficiency		0.78
Inertia moment	[kgm ²]	0.000046

Gear unit configuration

Output shaft		Hollow output shaft
Fixing		Universal
Version		B3
Attachment position		10

Output radial and axial loads

Ball bearings output radial load	[N]	2350
Taper bearings output radial load	[N]	3500
Ball bearings output axial load	[N]	470
Taper bearings output axial load	[N]	700

Accessories

Hollow output shaft		AC 24
---------------------	--	-------

Electric motor

Size		71 B4
Poles		4
Power	[kW]	0.37

Electric motor configuration

Motor flange		B14
Terminal box position		X3

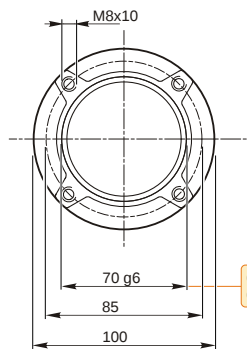
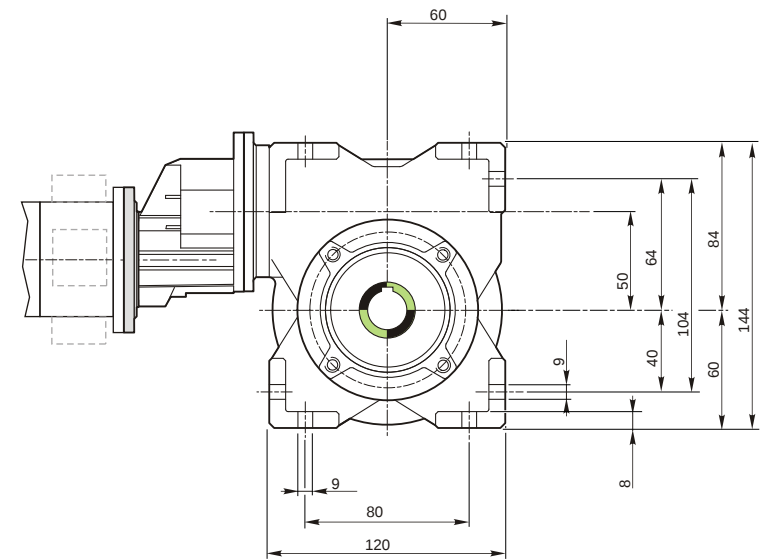
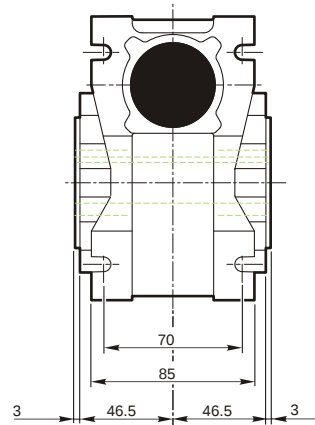
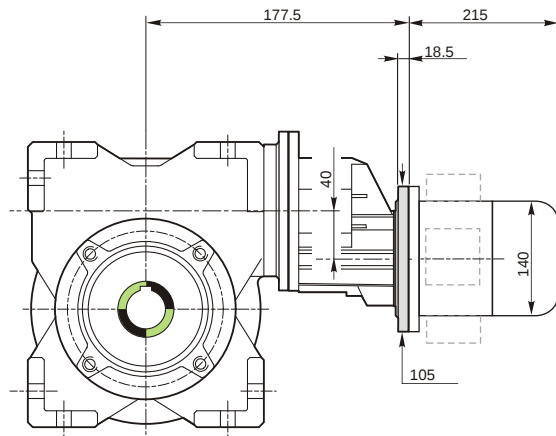

69.99
69.971

24.021
24.000

Hollow output shaft

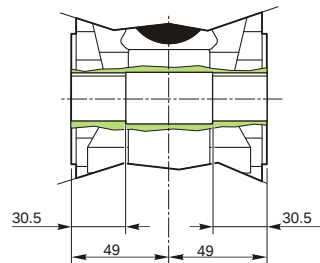
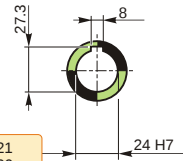

Attachment position

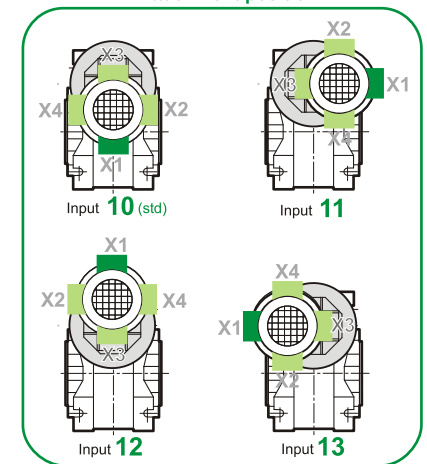

M TA 71/50 B3 10 44.8 71 B14 AC 24 MT 0.37 kW 71 B4 B14 X3

Mounting positions

B3

B6

B7

B8

V5

V6

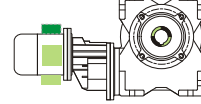
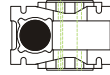
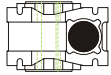
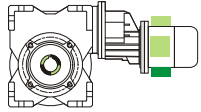

Terminal box position

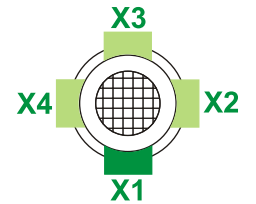

0.05	1	2	1
0.13	2	1	2

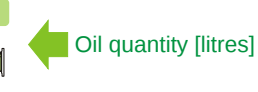

Lubricant type: Long life synthetic oil ISO VG320

Direction of rotation

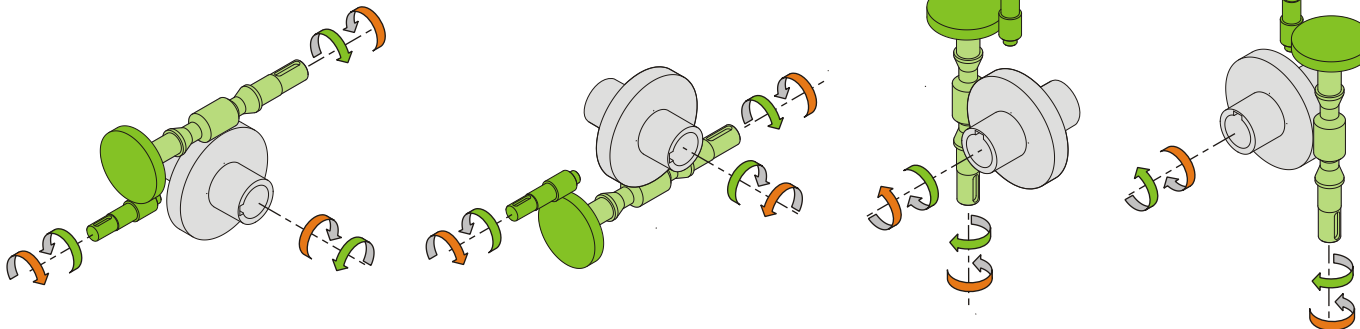

Weight

Gear unit [kg]	6.6
Electric motor [kg]	6.2

Gearing data

Axial module	2.7
Number of starts	
Lead angle	23° 52'
Pressure angle	20°

Backdriving

- Static back-driving
- Quick back-driving
- Dynamic back-driving

M TA 71/50 B3 10 44.8 71 B14 AC 24 MT 0.37 kW 71 B4 B14 X3