

Input data

System of measurement		Metric
Input type		Gear motor
Input speed	[rpm]	1400
Output speed	[rpm]	23.81
Ratio (i=)		58.8
Frequency	[Hz]	50
Input options		IEC
Requested input power	[kW]	1.5
Service factor		2.2
Rated Power P1	[kW]	3.26

Output data

Gear unit M TA 100/110 B3 10 58.8 90 B14 AC 42 MT 1.5 kW 90 L4 B14 X3

Type		TA - Worm speed reducers
Input type		M
Size		100/110
Ratio (i=)		58.8
Gearbox ratio		7.00
Pre-stage ratio		8.40
Input flange		B14
Input speed	[rpm]	1400
Output speed	[rpm]	23.81
Rated output torque	[Nm]	481.32
Service Factor		2.2
Efficiency		0.8

Gear unit configuration

Output shaft		Hollow output shaft
Fixing		Universal
Version		B3
Attachment position		10

Output radial and axial loads

Ball bearings output radial load	[N]	7800
Taper bearings output radial load	[N]	11100
Ball bearings output axial load	[N]	1560
Taper bearings output axial load	[N]	2220

Accessories

Hollow output shaft		AC 42
---------------------	--	-------

Electric motor

Size		90 L4
Poles		4
Power	[kW]	1.5

Electric motor configuration

Motor flange		B14
Terminal box position		X3

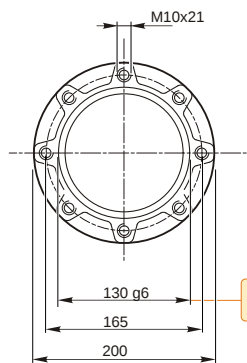
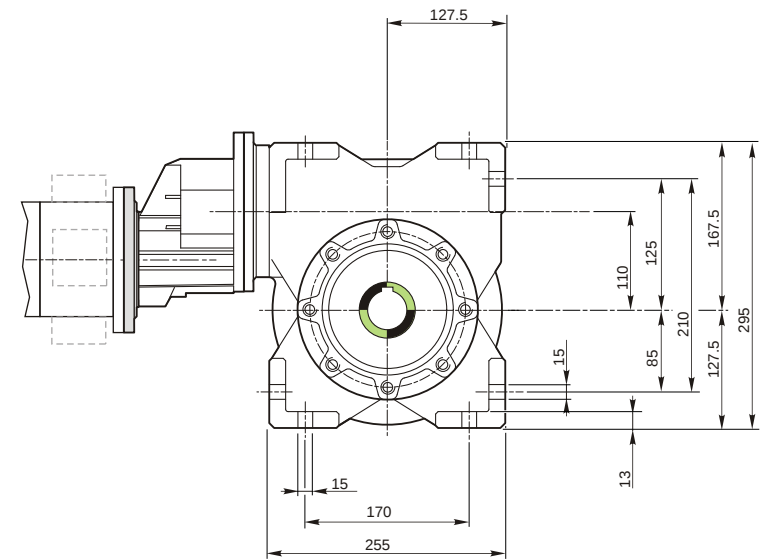
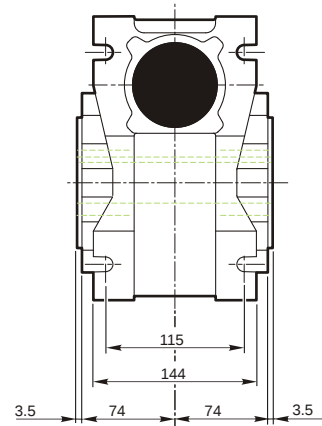
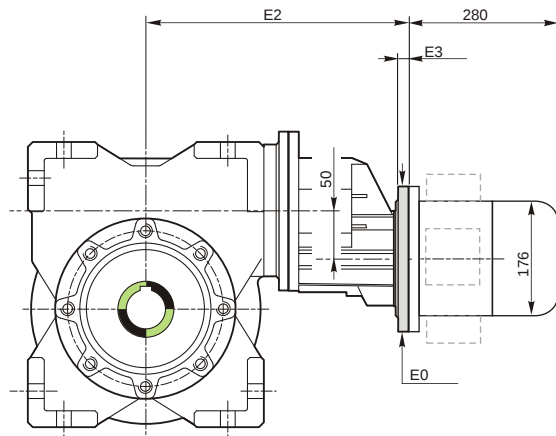

129.986
129.961

Hollow output shaft

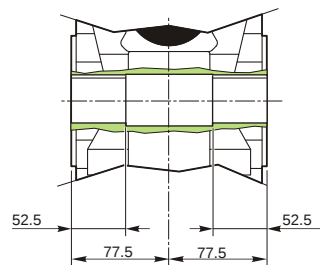
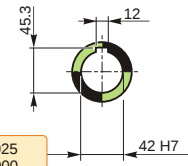

Attachment position

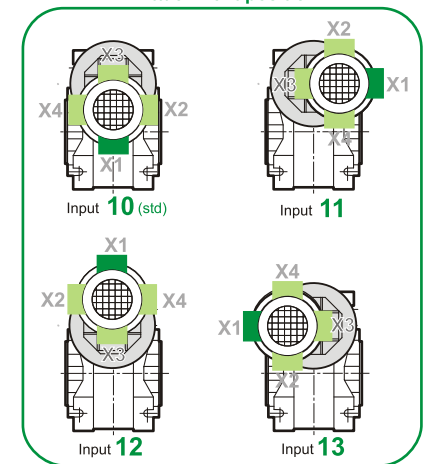

M TA 100/110 B3 10 58.8 90 B14 AC 42 MT 1.5 kW 90 L4 B14 X3

Mounting positions

B3

B6

B7

B8

V5

V6

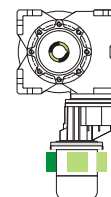
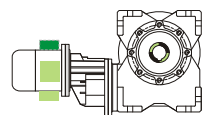
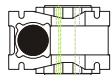
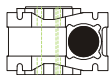
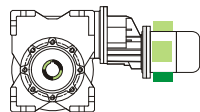

Terminal box position

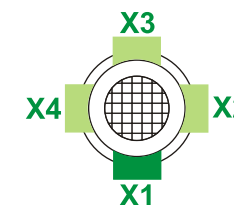

0.2

1



1.5

2



← Oil quantity [litres]

Lubricant type: Long life synthetic oil ISO VG320

Direction of rotation

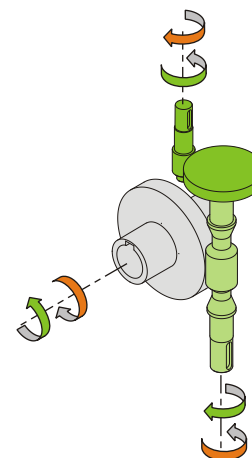
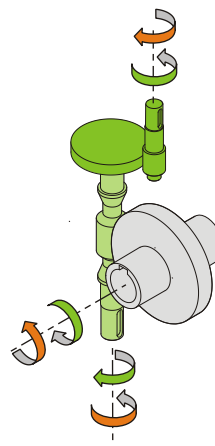
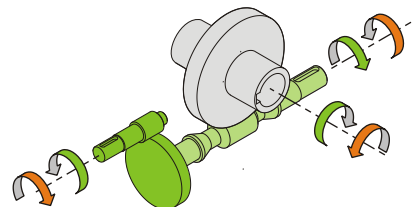
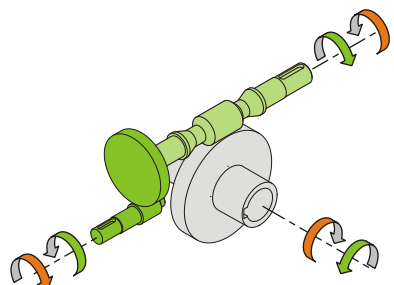

Weight

Gear unit [kg]	46
Electric motor [kg]	13.5

Gearing data

Axial module	6.1
Number of starts	4
Lead angle	6° 22'
Pressure angle	20°

Backdriving

Static back-driving
Quick back-driving
Dynamic back-driving

M TA 100/110 B3 10 58.8 90 B14 AC 42 MT 1.5 kW 90 L4 B14 X3