

### Input data

System of measurement		Metric
Input type		Gear motor
Input speed	[rpm]	1400
Output speed	[rpm]	21.88
Ratio (i=)		64
Frequency	[Hz]	50
Input options		IEC
Requested input power	[kW]	0.37
Service factor		1.1
Rated Power P1	[kW]	0.41

### Output data

**Gear unit** **M RA 71/50 PC 10 64 71 B14 AC 24 MT 0.37 kW 71 B4 B14 X3 B3**

Type		RA - Worm speed reducers
Input type		M
Size		71/50
Ratio (i=)		64
Gearbox ratio		10.00
Pre-stage ratio		6.40
Input flange		B14
Mounting position		B3
Input speed	[rpm]	1400
Output speed	[rpm]	21.88
Rated output torque	[Nm]	119.53
Service Factor		1.1
Efficiency		0.74
Inertia moment	[kgm <sup>2</sup> ]	0.000046

#### Gear unit configuration

Output shaft		Hollow output shaft
Fixing		Shaft mounting
Version		PC
Attachment position		10

#### Output radial and axial loads

Ball bearings output radial load	[N]	2700
Taper bearings output radial load	[N]	4050
Ball bearings output axial load	[N]	540
Taper bearings output axial load	[N]	810

#### Accessories

Hollow output shaft		AC 24
---------------------	--	-------

#### Electric motor

Size		71 B4
Poles		4
Power	[kW]	0.37

#### Electric motor configuration

Motor flange		B14
Terminal box position		X3

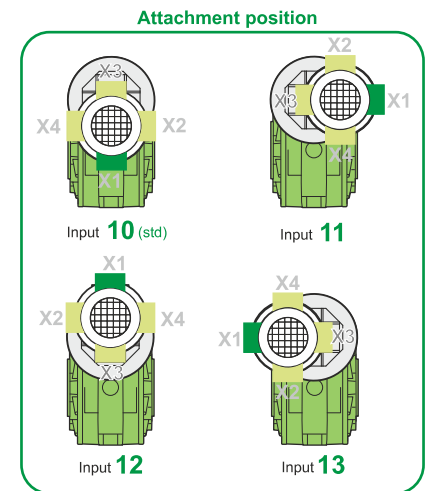
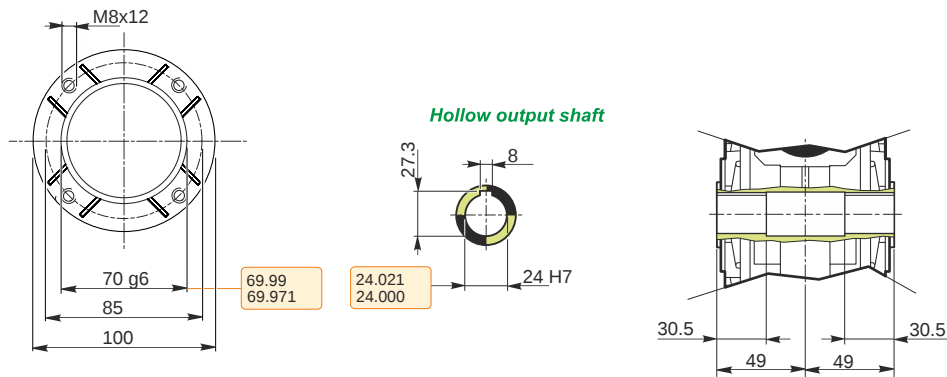
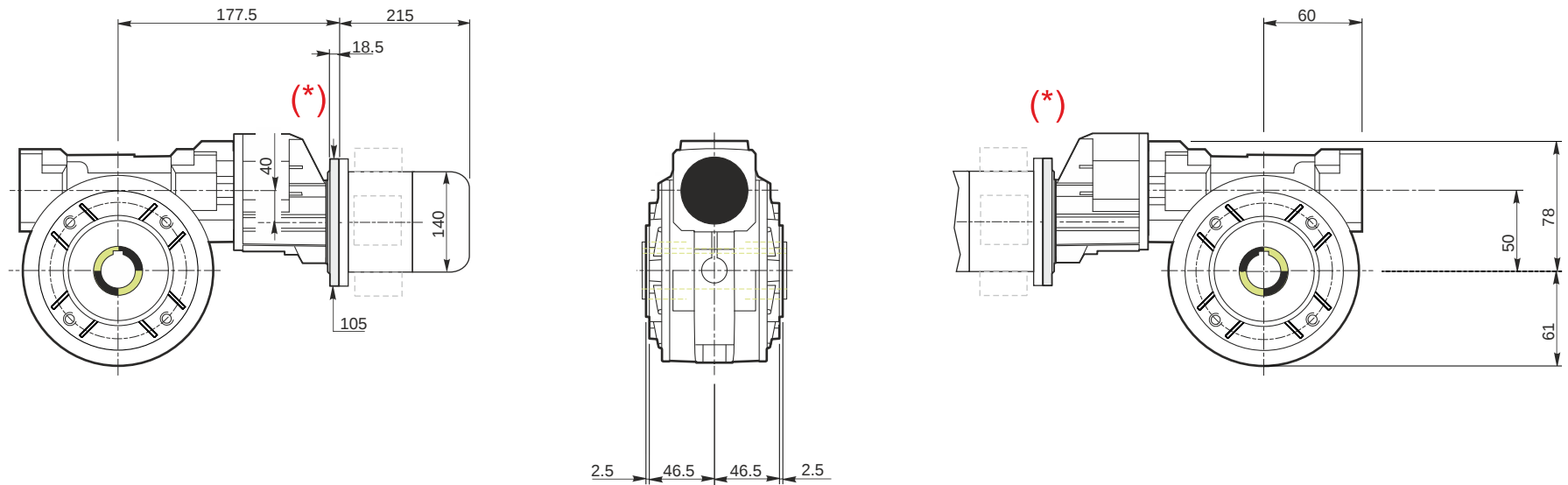

**M RA 71/50 PC 10 64 71 B14 AC 24 MT 0.37 kW 71 B4 B14 X3 B3**

### Mounting positions

B3

B6

B7

B8

V5

V6

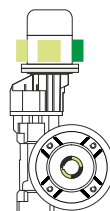
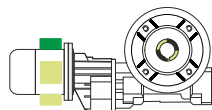
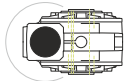
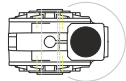
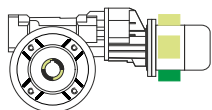

Terminal box position

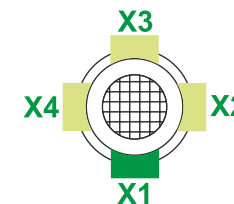

0.05

1

0.13

2

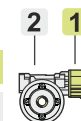

Oil quantity [litres]

Lubricant type: Long life synthetic oil ISO VG320

### Direction of rotation

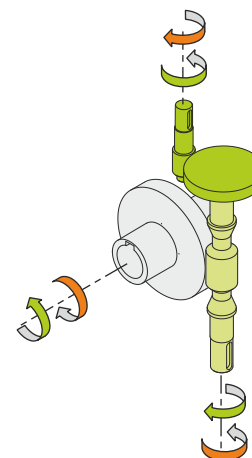
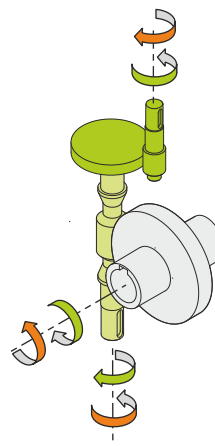
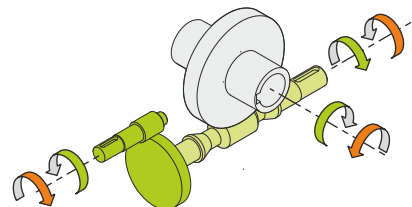
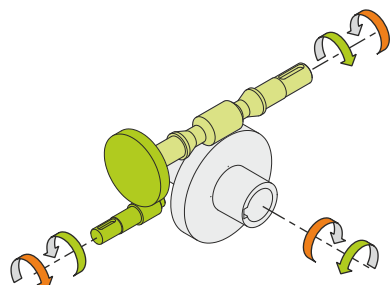

### Weight

Gear unit [kg]	6.6
Electric motor [kg]	6.2

### Gearing data

Axial module	2.5
Number of starts	3
Lead angle	16° 41'
Pressure angle	20°

### Backdriving

Static back-driving  
Quick back-driving  
Dynamic back-driving

**M RA 71/50 PC 10 64 71 B14 AC 24 MT 0.37 kW 71 B4 B14 X3 B3**