

Input data

System of measurement		Metric
Input type		Gear motor
Input speed	[rpm]	1400
Output speed	[rpm]	14.58
Ratio (i=)		96
Frequency	[Hz]	50
Input options		IEC
Requested input power	[kW]	0.25
Service factor		1.2
Rated Power P1	[kW]	0.3

Output data

Gear unit	M RA 71/50 PC 10 96 71 B14 AC 24 MT 0.25 kW 71 A4 B14 X3 B3
------------------	--

Type		RA - Worm speed reducers
Input type		M
Size		71/50
Ratio (i=)		96
Gearbox ratio		15.00
Pre-stage ratio		6.40
Input flange		B14
Mounting position		B3
Input speed	[rpm]	1400
Output speed	[rpm]	14.58
Rated output torque	[Nm]	109.69
Service Factor		1.2
Efficiency		0.67
Inertia moment	[kgm ²]	0.000046

Gear unit configuration

Output shaft		Hollow output shaft
Fixing		Shaft mounting
Version		PC
Attachment position		10

Output radial and axial loads

Ball bearings output radial load	[N]	3150
Taper bearings output radial load	[N]	4200
Ball bearings output axial load	[N]	630
Taper bearings output axial load	[N]	840

Accessories

Hollow output shaft		AC 24
---------------------	--	-------

Electric motor

Size		71 A4
Poles		4
Power	[kW]	0.25

Electric motor configuration

Motor flange		B14
Terminal box position		X3

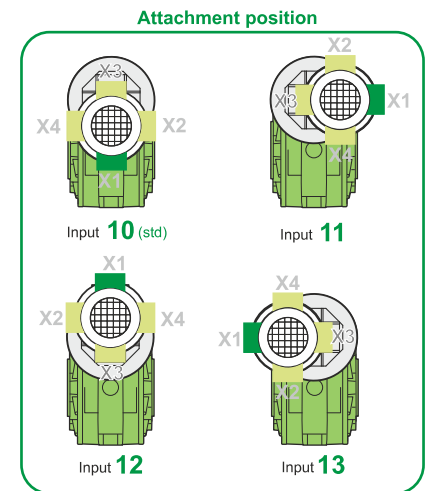
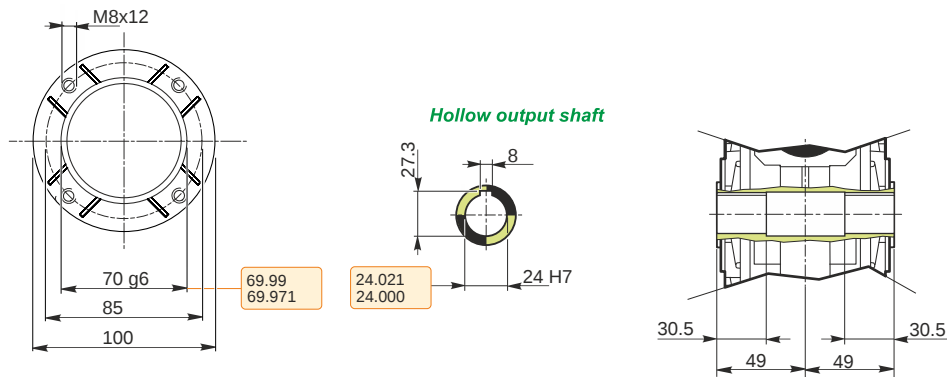
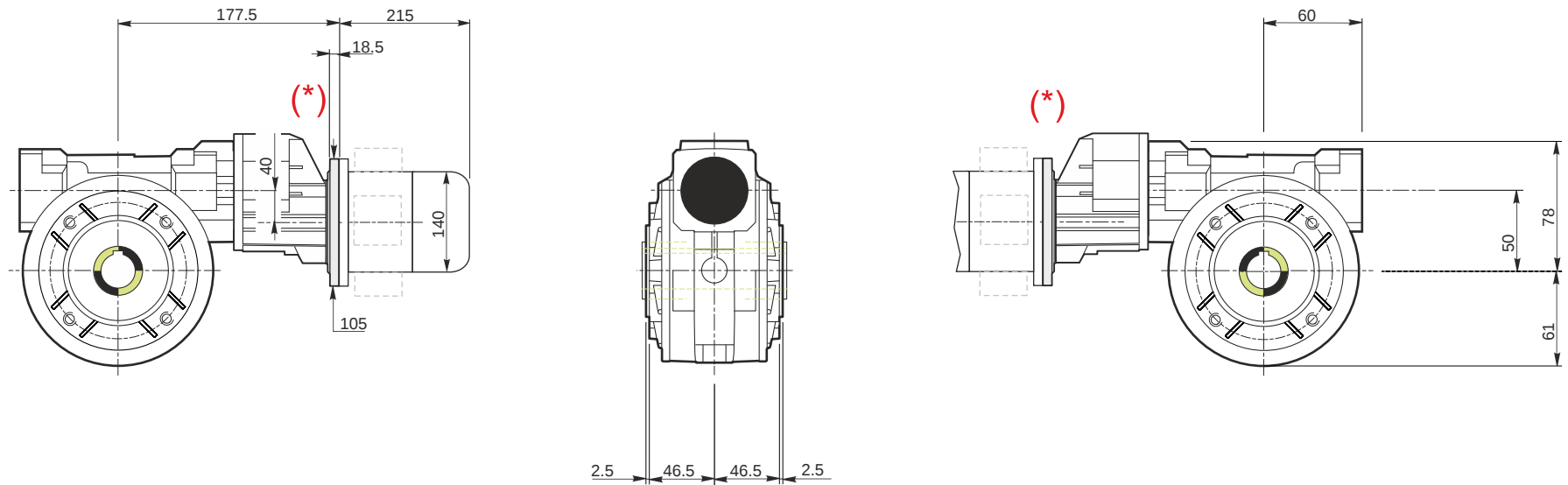

M RA 71/50 PC 10 96 71 B14 AC 24 MT 0.25 kW 71 A4 B14 X3 B3

Mounting positions

B3

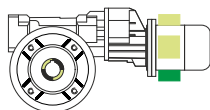

B6

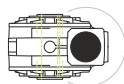

B7

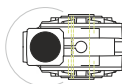

B8

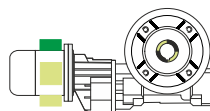

V5

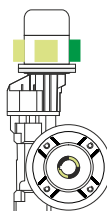

V6



Terminal box position

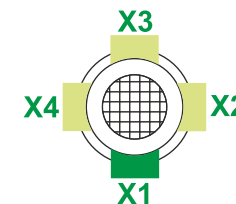

0.05

1

0.13

2

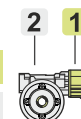

Oil quantity [litres]

Lubricant type: Long life synthetic oil ISO VG320

Direction of rotation

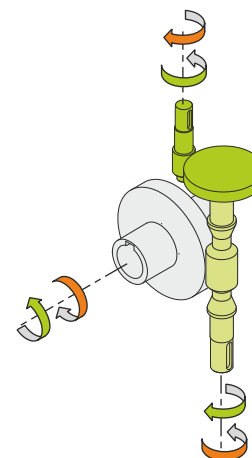
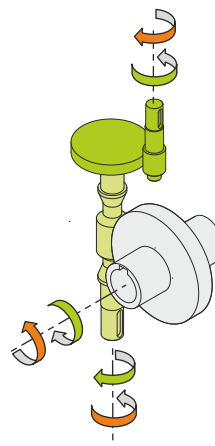
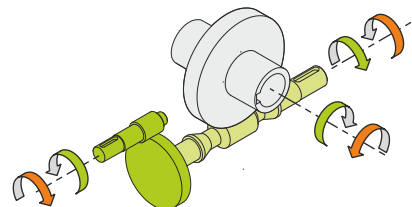
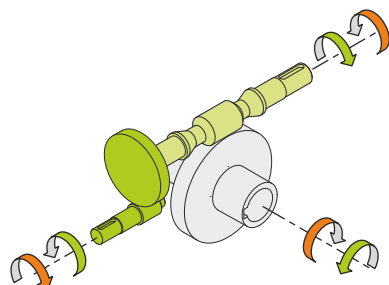

Weight

Gear unit [kg]	6.6
Electric motor [kg]	6.2

Gearing data

Axial module	2.5
Number of starts	2
Lead angle	11° 18'
Pressure angle	20°

Backdriving

Variable static self-locking
Quick back-driving in case of vibrations
Dynamic back-driving

M RA 71/50 PC 10 96 71 B14 AC 24 MT 0.25 kW 71 A4 B14 X3 B3