

Input data

System of measurement		Metric
Input type		Gear motor
Input speed	[rpm]	1400
Output speed	[rpm]	5.47
Ratio (i=)		256
Frequency	[Hz]	50
Input options		IEC
Requested input power	[kW]	0.55
Service factor		0.9
Rated Power P1	[kW]	0.52

Output data

Gear unit	M RA 80/85 PC 10 256 80 B14 AC 32 MT 0.55 kW 80 A4 B14 X3 B3	
------------------	---	--

Type		RA - Worm speed reducers
Input type		M
Size		80/85
Ratio (i=)		256
Gearbox ratio		40.00
Pre-stage ratio		6.40
Input flange		B14
Mounting position		B3
Input speed	[rpm]	1400
Output speed	[rpm]	5.47
Rated output torque	[Nm]	528.25
Service Factor		0.9
Efficiency		0.55
Inertia moment	[kgm ²]	0.000264

Gear unit configuration

Output shaft		Hollow output shaft
Fixing		Shaft mounting
Version		PC
Attachment position		10

Output radial and axial loads

Ball bearings output radial load	[N]	8300
Taper bearings output radial load	[N]	9400
Ball bearings output axial load	[N]	1660
Taper bearings output axial load	[N]	1880

Accessories

Hollow output shaft		AC 32
---------------------	--	-------

Electric motor

Size		80 A4
Poles		4
Power	[kW]	0.55

Electric motor configuration

Motor flange		B14
Terminal box position		X3

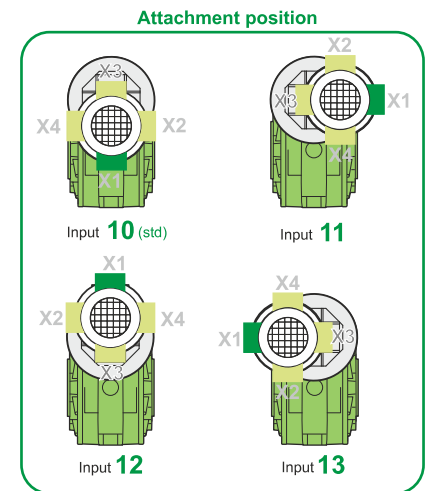
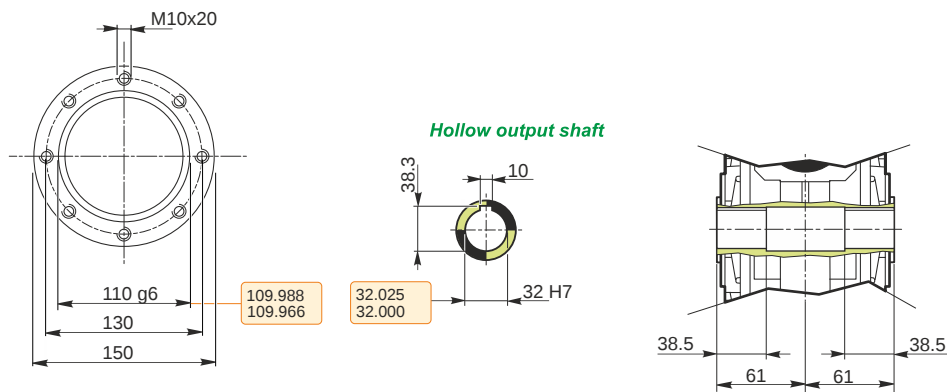
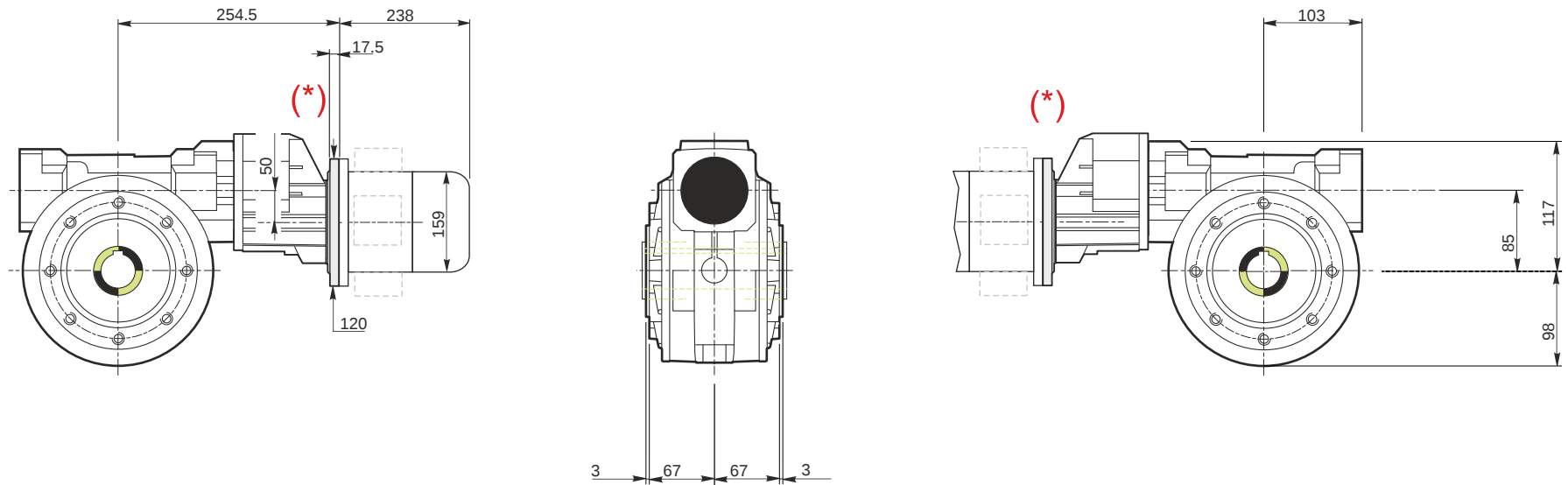

Mounting positions

B3

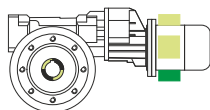

B6

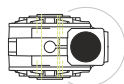

B7

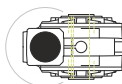

B8

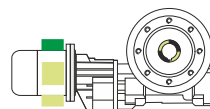

V5

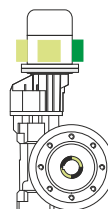

V6

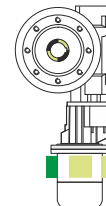

Terminal box position

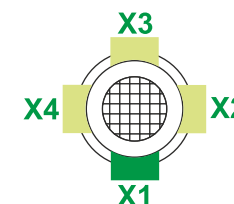

0.1

1

0.6

2

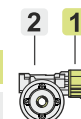

Oil quantity [litres]

Lubricant type: Long life synthetic oil ISO VG320

Direction of rotation

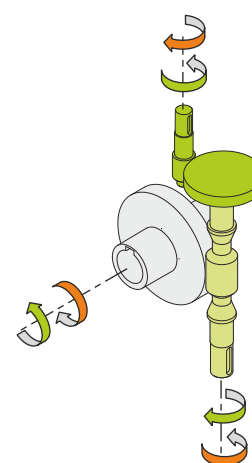
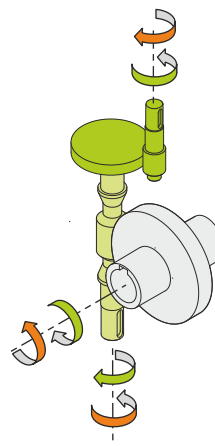
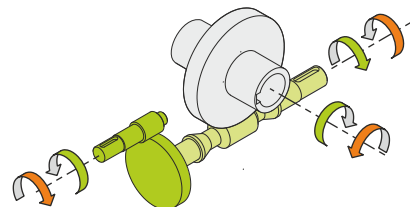
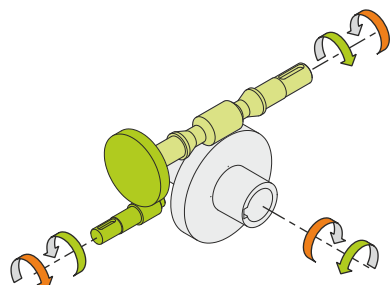

Weight

Gear unit [kg]	17.5
Electric motor [kg]	9.8

Gearing data

Axial module	3.4
Number of starts	1
Lead angle	5° 52'
Pressure angle	20°

Backdriving

Static self-locking
Slow back-driving in case of vibrations
Low dynamic back-driving

M RA 80/85 PC 10 256 80 B14 AC 32 MT 0.55 kW 80 A4 B14 X3 B3