

Input data

System of measurement		Metric
Input type		Gear motor
Input speed	[rpm]	1400
Output speed	[rpm]	10.94
Ratio (i=)		128
Frequency	[Hz]	50
Input options		IEC
Requested input power	[kW]	1.5
Service factor		1.2
Rated Power P1	[kW]	1.77

Output data

Gear unit	M RA 80/110 PC 10 128 90 B14 AC 42 MT 1.5 kW 90 L4 B14 X3 B3	
------------------	---	--

Type		RA - Worm speed reducers
Input type		M
Size		80/110
Ratio (i=)		128
Gearbox ratio		20.00
Pre-stage ratio		6.40
Input flange		B14
Mounting position		B3
Input speed	[rpm]	1400
Output speed	[rpm]	10.94
Rated output torque	[Nm]	929.9
Service Factor		1.2
Efficiency		0.71
Inertia moment	[kgm ²]	0.0003

Gear unit configuration

Output shaft		Hollow output shaft
Fixing		Shaft mounting
Version		PC
Attachment position		10

Output radial and axial loads

Ball bearings output radial load	[N]	9800
Taper bearings output radial load	[N]	11100
Ball bearings output axial load	[N]	1960
Taper bearings output axial load	[N]	2220

Accessories

Hollow output shaft		AC 42
---------------------	--	-------

Electric motor

Size		90 L4
Poles		4
Power	[kW]	1.5

Electric motor configuration

Motor flange		B14
Terminal box position		X3

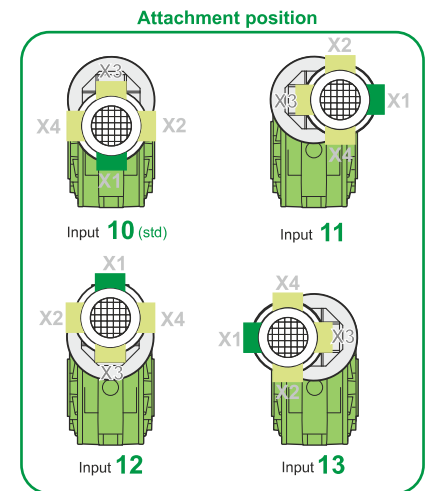
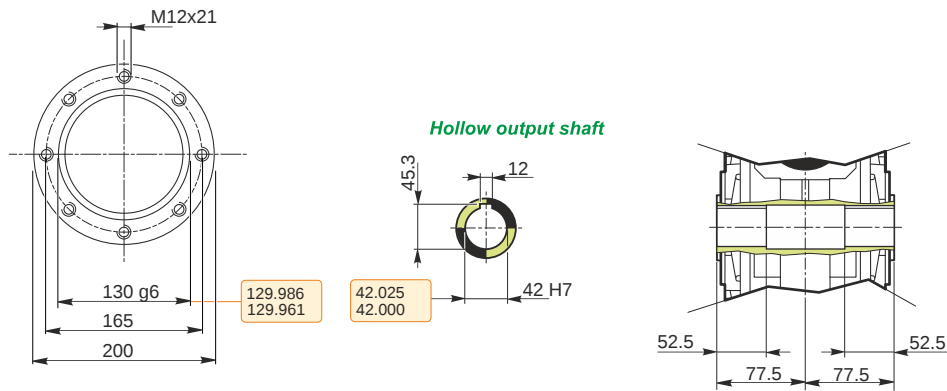
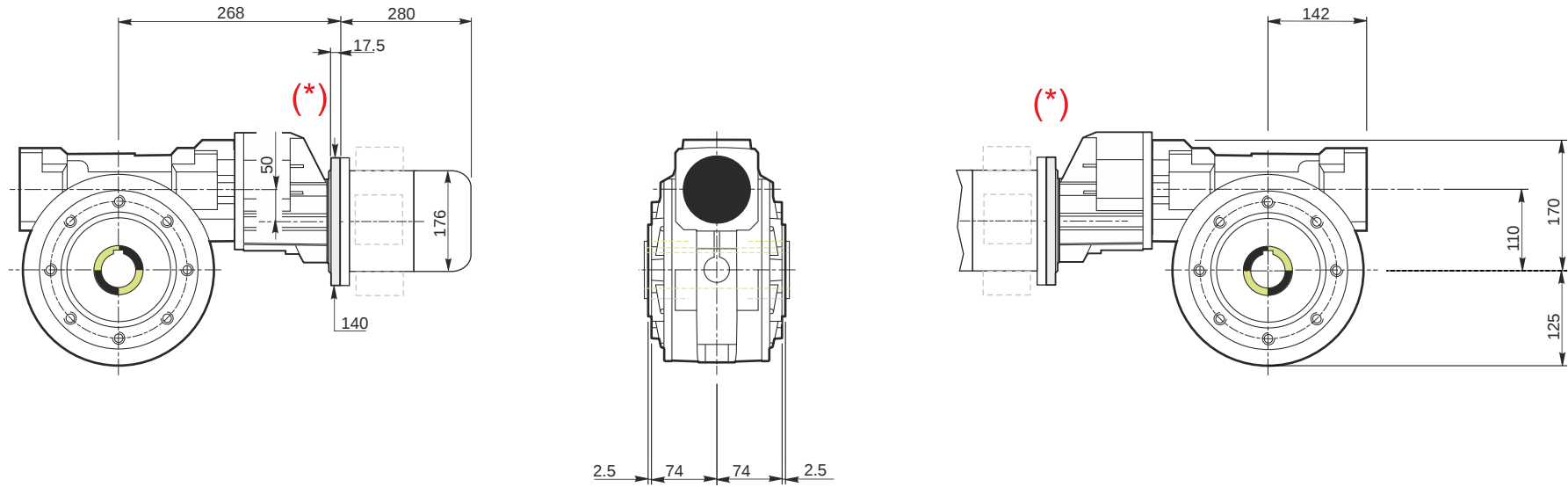

M RA 80/110 PC 10 128 90 B14 AC 42 MT 1.5 kW 90 L4 B14 X3 B3

Mounting positions

B3

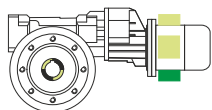

B6

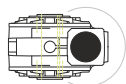

B7

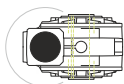

B8

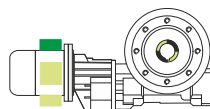

V5

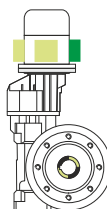

V6



Terminal box position

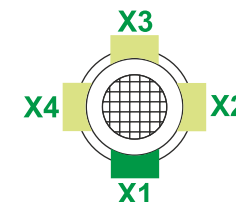

0.1

1

1.5

2

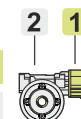

Oil quantity [litres]

Lubricant type: Long life synthetic oil ISO VG320

Direction of rotation

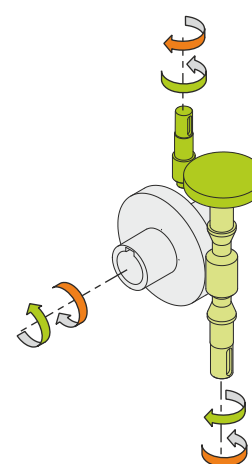
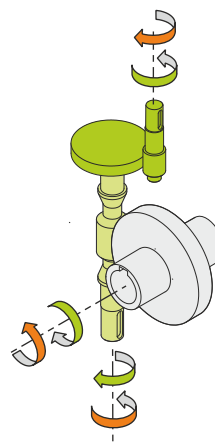
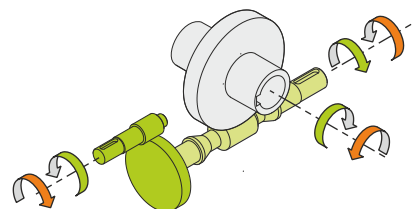
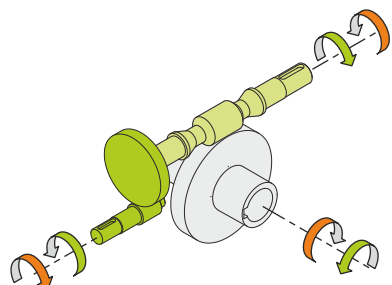

Weight

Gear unit [kg]	43
Electric motor [kg]	13.5

Gearing data

Axial module	4.4
Number of starts	2
Lead angle	11° 18'
Pressure angle	20°

Backdriving

Variable static self-locking
Quick back-driving in case of vibrations
Dynamic back-driving

M RA 80/110 PC 10 128 90 B14 AC 42 MT 1.5 kW 90 L4 B14 X3 B3