

Input data

System of measurement		Metric
Input type		Gear motor
Input speed	[rpm]	1400
Output speed	[rpm]	4.46
Ratio (i=)		313.6
Frequency	[Hz]	50
Input options		IEC
Requested input power	[kW]	1.1
Service factor		0.9
Rated Power P1	[kW]	0.97

Output data

Gear unit **M RA 80/110 PC 10 313.6 90 B14 AC 42 MT 1.1 kW 90 S4 B14 X3 B3**

Type		RA - Worm speed reducers
Input type		M
Size		80/110
Ratio (i=)		313.6
Gearbox ratio		49.00
Pre-stage ratio		6.40
Input flange		B14
Mounting position		B3
Input speed	[rpm]	1400
Output speed	[rpm]	4.46
Rated output torque	[Nm]	1247.15
Service Factor		0.9
Efficiency		0.53
Inertia moment	[kgm ²]	0.000298

Gear unit configuration

Output shaft		Hollow output shaft
Fixing		Shaft mounting
Version		PC
Attachment position		10

Output radial and axial loads

Ball bearings output radial load	[N]	9800
Taper bearings output radial load	[N]	11100
Ball bearings output axial load	[N]	1960
Taper bearings output axial load	[N]	2220

Accessories

Hollow output shaft		AC 42
---------------------	--	-------

Electric motor

Size		90 S4
Poles		4
Power	[kW]	1.1

Electric motor configuration

Motor flange		B14
Terminal box position		X3

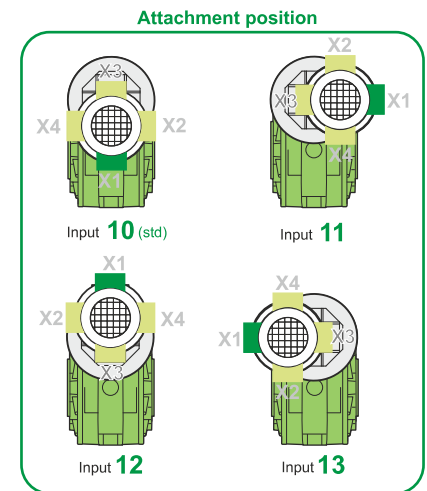
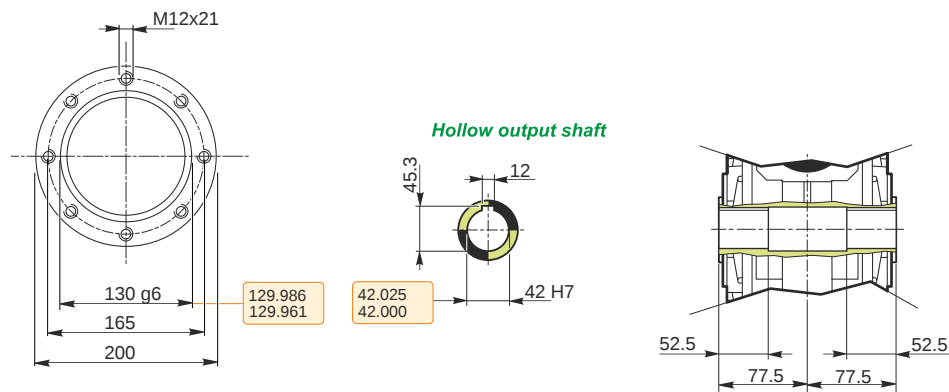
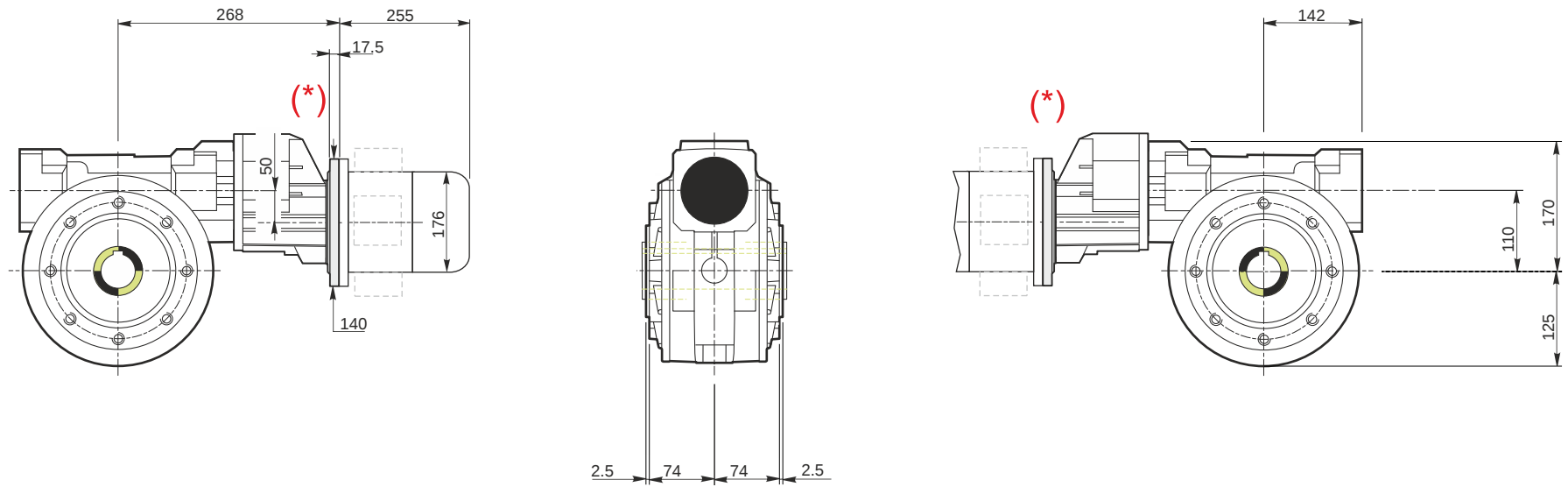

Mounting positions

B3

B6

B7

B8

V5

V6

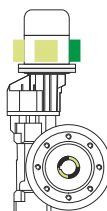
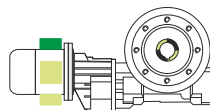
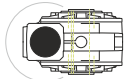
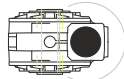
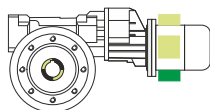

Terminal box position

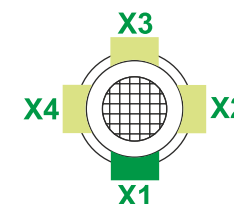

0.1	1
1.5	2

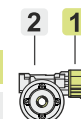

Oil quantity [litres]

Lubricant type: Long life synthetic oil ISO VG320

Direction of rotation

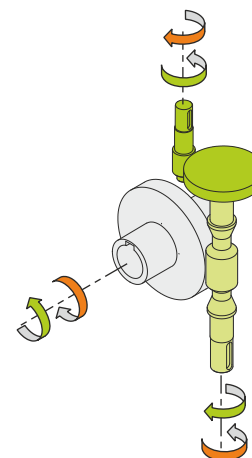
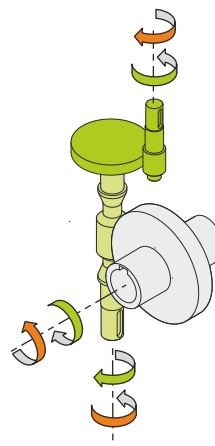
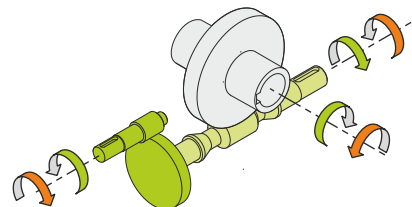
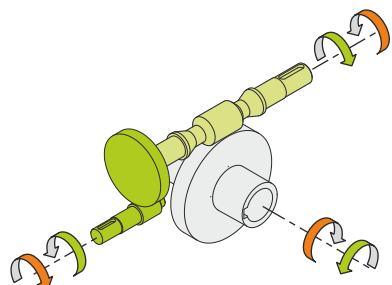

Weight

Gear unit [kg]	43
Electric motor [kg]	12

Gearing data

Axial module	3.6
Number of starts	1
Lead angle	4° 43'
Pressure angle	20°

Backdriving

Static self-locking
Slow back-driving in case of vibrations
Low dynamic back-driving