

Input data

System of measurement		Metric
Input type		Gear motor
Input speed	[rpm]	1400
Output speed	[rpm]	18.04
Ratio (i=)		77.6
Frequency	[Hz]	50
Input options		IEC
Requested input power	[kW]	1.5
Service factor		1.6
Rated Power P1	[kW]	2.35

Output data

Gear unit	M RA 100/110 PC 10 77.6 90 B14 AC 42 MT 1.5 kW 90 L4 B14 X3 B3
------------------	---

Type		RA - Worm speed reducers
Input type		M
Size		100/110
Ratio (i=)		77.6
Gearbox ratio		20.00
Pre-stage ratio		3.88
Input flange		B14
Mounting position		B3
Input speed	[rpm]	1400
Output speed	[rpm]	18.04
Rated output torque	[Nm]	579.63
Service Factor		1.6
Efficiency		0.73

Gear unit configuration

Output shaft		Hollow output shaft
Fixing		Shaft mounting
Version		PC
Attachment position		10

Output radial and axial loads

Ball bearings output radial load	[N]	8000
Taper bearings output radial load	[N]	11100
Ball bearings output axial load	[N]	1600
Taper bearings output axial load	[N]	2220

Accessories

Hollow output shaft		AC 42
---------------------	--	-------

Electric motor

Size		90 L4
Poles		4
Power	[kW]	1.5

Electric motor configuration

Motor flange		B14
Terminal box position		X3

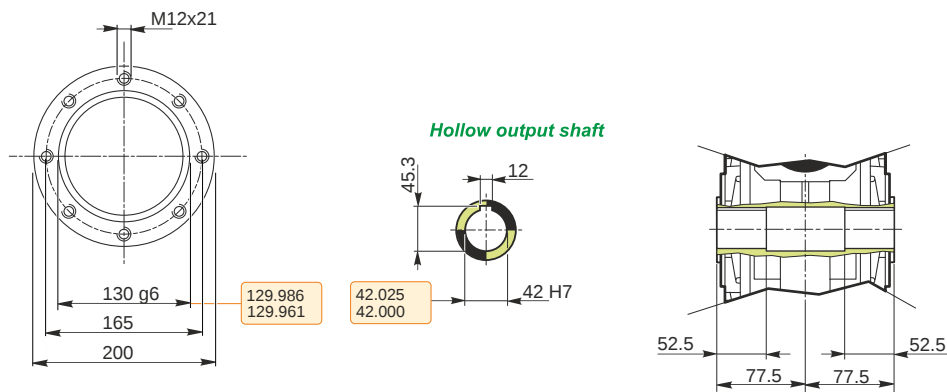
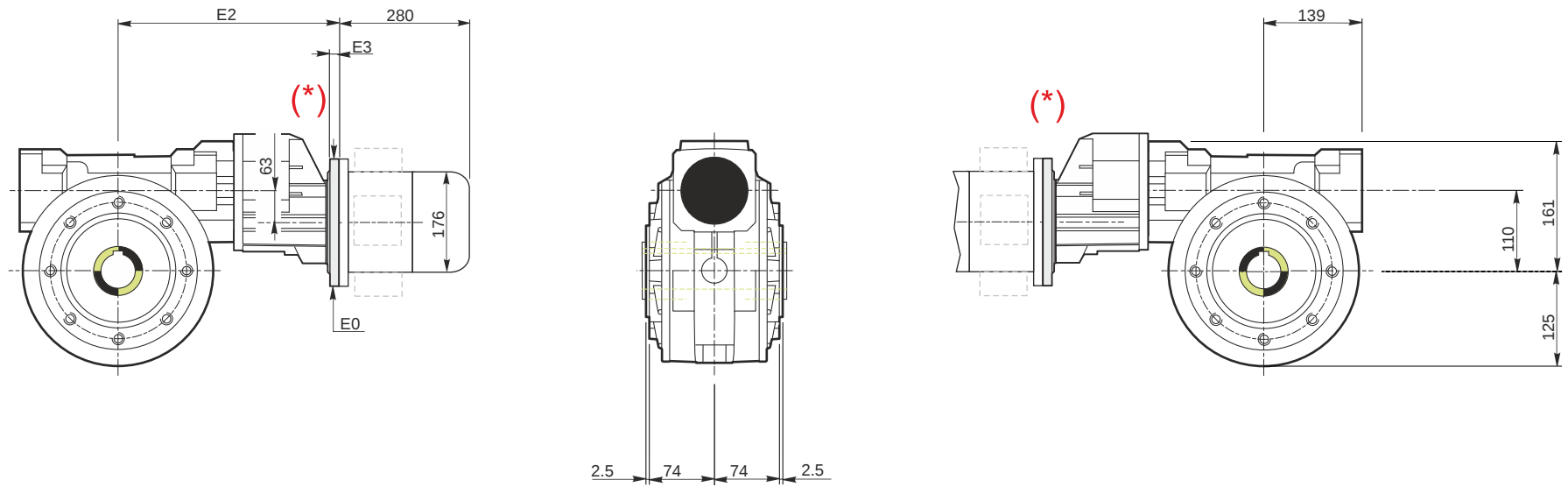

Hollow output shaft

Attachment position

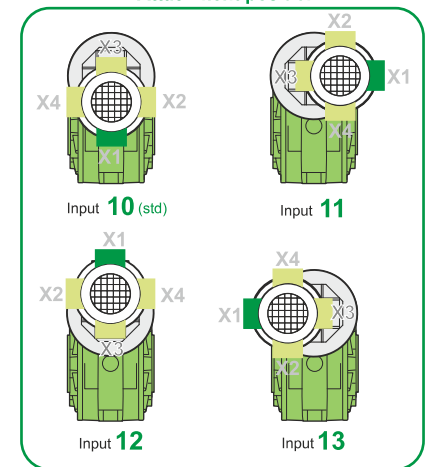

Mounting positions

B3

B6

B7

B8

V5

V6

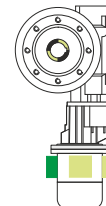
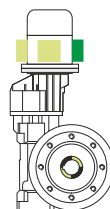
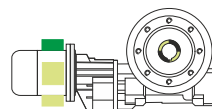
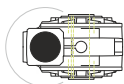
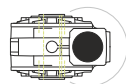
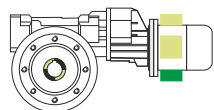

Terminal box position

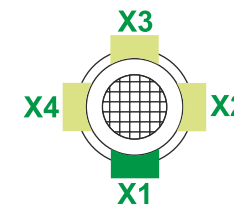

0.2

1

1.5

2

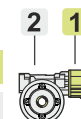

Oil quantity [litres]

Lubricant type: Long life synthetic oil ISO VG320

Direction of rotation

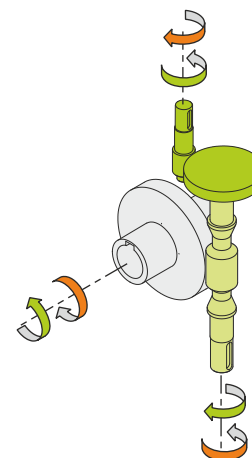
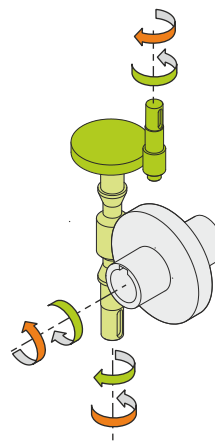
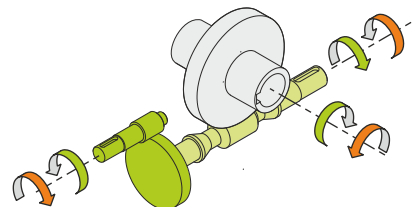
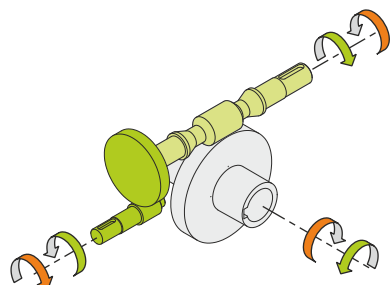

Weight

Gear unit [kg]	46
Electric motor [kg]	13.5

Gearing data

Axial module	4.4
Number of starts	2
Lead angle	11° 18'
Pressure angle	20°

Backdriving

Variable static self-locking
Quick back-driving in case of vibrations
Dynamic back-driving

M RA 100/110 PC 10 77.6 90 B14 AC 42 MT 1.5 kW 90 L4 B14 X3 B3