

Input data

System of measurement		Metric
Input type		Gear motor
Input speed	[rpm]	1400
Output speed	[rpm]	18.04
Ratio (i=)		77.6
Frequency	[Hz]	50
Input options		IEC
Requested input power	[kW]	3
Service factor		1.1
Rated Power P1	[kW]	3.4

Output data

Gear unit **M RA 100/130 PC 10 77.6 100 B14 AC 48 MT 3 kW 100 B4 B14 X3 B3**

Type		RA - Worm speed reducers
Input type		M
Size		100/130
Ratio (i=)		77.6
Gearbox ratio		20.00
Pre-stage ratio		3.88
Input flange		B14
Mounting position		B3
Input speed	[rpm]	1400
Output speed	[rpm]	18.04
Rated output torque	[Nm]	1191.02
Service Factor		1.1
Efficiency		0.75

Gear unit configuration

Output shaft		Hollow output shaft
Fixing		Shaft mounting
Version		PC
Attachment position		10

Output radial and axial loads

Ball bearings output radial load	[N]	6500
Taper bearings output radial load	[N]	9700
Ball bearings output axial load	[N]	1300
Taper bearings output axial load	[N]	1940

Accessories

Hollow output shaft		AC 48
---------------------	--	-------

Electric motor

Size		100 B4
Poles		4
Power	[kW]	3

Electric motor configuration

Motor flange		B14
Terminal box position		X3

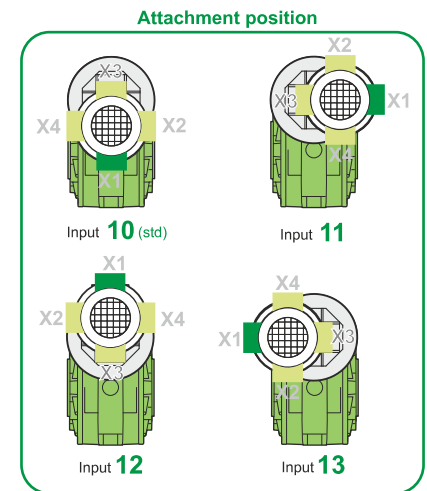
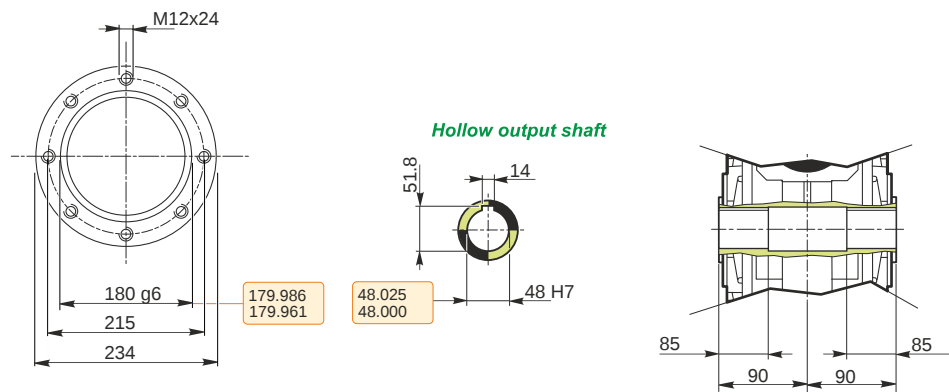
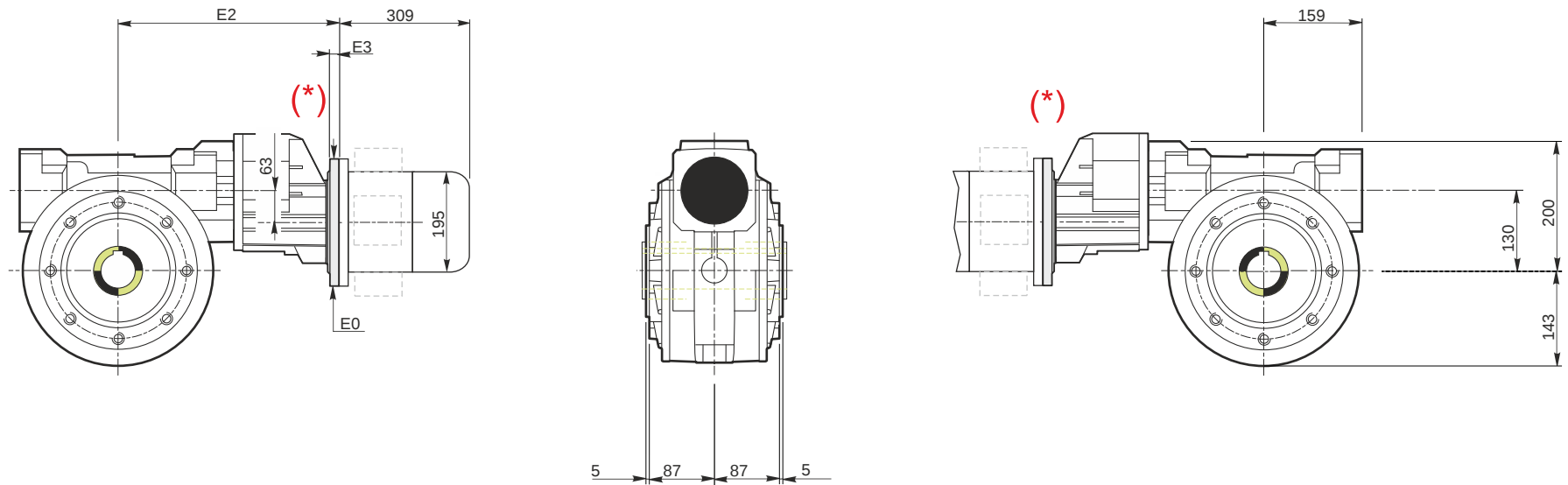

M RA 100/130 PC 10 77.6 100 B14 AC 48 MT 3 kW 100 B4 B14 X3 B3

Mounting positions

B3

B6

B7

B8

V5

V6

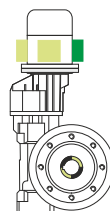
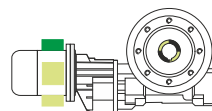
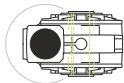
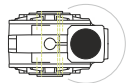
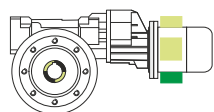

Terminal box position

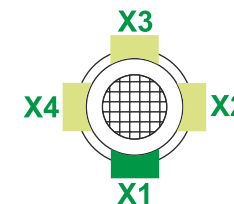

0.2

1

2.75

2

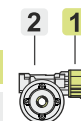

Oil quantity [litres]

Lubricant type: Long life synthetic oil ISO VG320

Direction of rotation

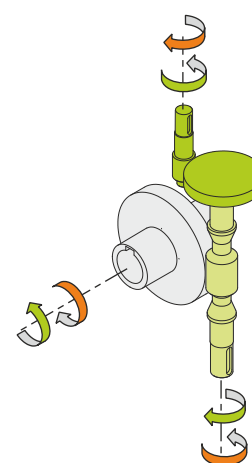
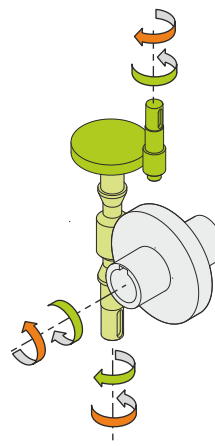
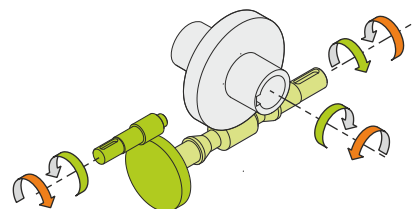
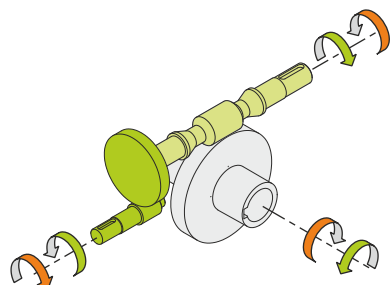

Weight

Gear unit [kg]	64
Electric motor [kg]	21

Gearing data

Axial module	5.35
Number of starts	2
Lead angle	13° 05'
Pressure angle	20°

Backdriving

Static back-driving
Quick back-driving
Dynamic back-driving