

Input data

System of measurement		Metric
Input type		Gear motor
Input speed	[rpm]	1400
Output speed	[rpm]	18.04
Ratio (i=)		77.6
Frequency	[Hz]	50
Input options		IEC
Requested input power	[kW]	3
Service factor		1.7
Rated Power P1	[kW]	5.12

Output data

Gear unit	M RA 100/150 PC 10 77.6 100 B14 AC 55 MT 3 kW 100 B4 B14 X3 B3
------------------	---

Type		RA - Worm speed reducers
Input type		M
Size		100/150
Ratio (i=)		77.6
Gearbox ratio		20.00
Pre-stage ratio		3.88
Input flange		B14
Mounting position		B3
Input speed	[rpm]	1400
Output speed	[rpm]	18.04
Rated output torque	[Nm]	1206.9
Service Factor		1.7
Efficiency		0.76

Gear unit configuration

Output shaft		Hollow output shaft
Fixing		Shaft mounting
Version		PC
Attachment position		10

Output radial and axial loads

Ball bearings output radial load	[N]	13000
Taper bearings output radial load	[N]	19500
Ball bearings output axial load	[N]	2600
Taper bearings output axial load	[N]	3900

Accessories

Hollow output shaft		AC 55
---------------------	--	-------

Electric motor

Size		100 B4
Poles		4
Power	[kW]	3

Electric motor configuration

Motor flange		B14
Terminal box position		X3

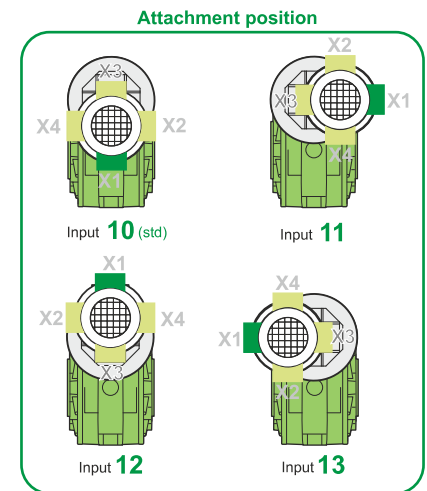
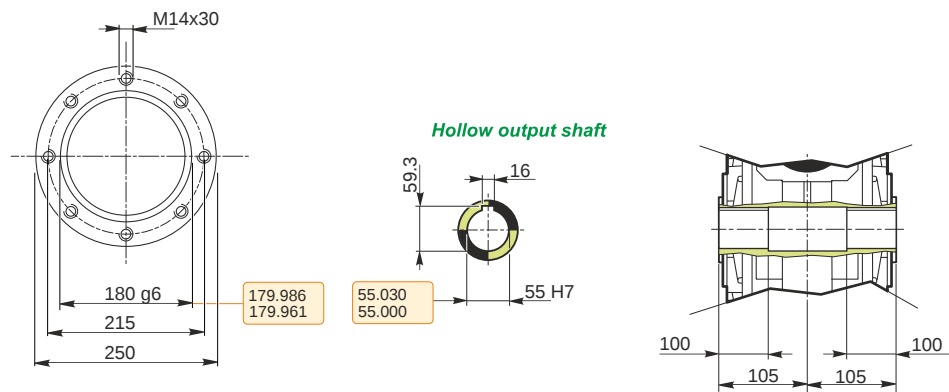
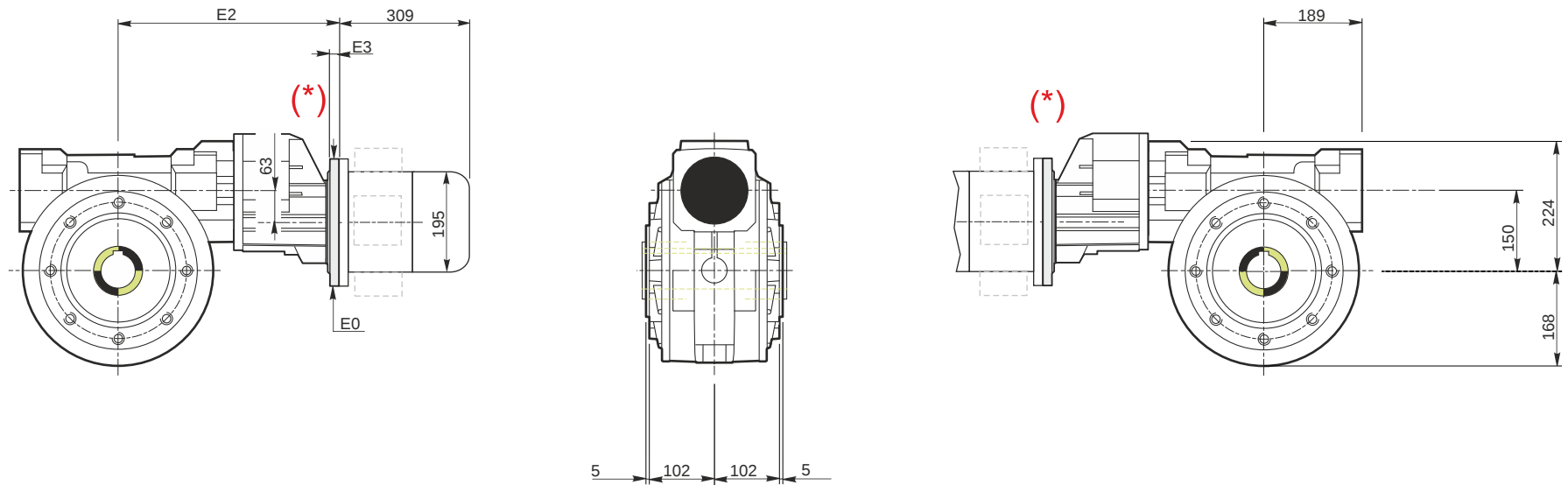

M RA 100/150 PC 10 77.6 100 B14 AC 55 MT 3 kW 100 B4 B14 X3 B3

Mounting positions

B3

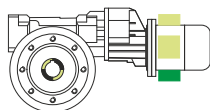

B6

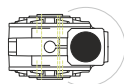

B7

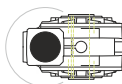

B8

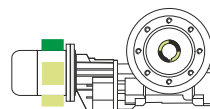

V5

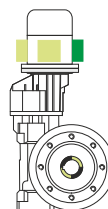

V6

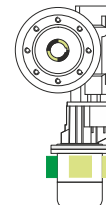

Terminal box position

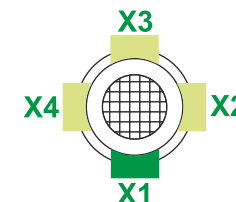

0.2	1
4.4	2

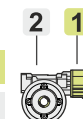

Oil quantity [litres]

Lubricant type: Long life synthetic oil ISO VG320

Direction of rotation

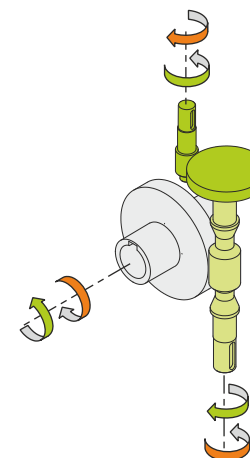
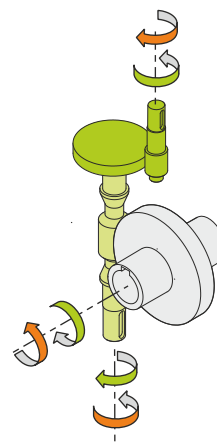
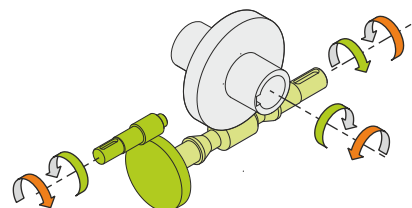
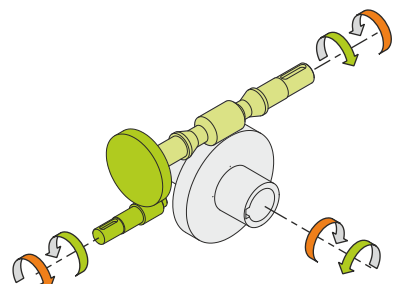

Weight

Gear unit [kg]	94
Electric motor [kg]	21

Gearing data

Axial module	6.20
Number of starts	2
Lead angle	13° 24'
Pressure angle	20°

Backdriving

Static back-driving
Quick back-driving
Dynamic back-driving