

### Input data

System of measurement		Metric
Input type		Gear motor
Input speed	[rpm]	1400
Output speed	[rpm]	85.78
Ratio (i=)		16.32
Frequency	[Hz]	50
Input options		IEC
Requested input power	[kW]	0.37
Service factor		1.3
Rated Power P1	[kW]	0.48

### Output data

**Gear unit** **M RD 02 B3 H1 16.32 71 B14 AU 20x40 MT 0.37 kW 71 B4 B14 X3**

Type		RD - Helical gearboxes
Input type		M
Size		02
Ratio (i=)		16.32
Input flange		B14
Mounting position		H1
Input speed	[rpm]	1400
Output speed	[rpm]	85.78
Rated output torque	[Nm]	39.54
Service Factor		1.3
Efficiency		0.96
Inertia moment	[kgm <sup>2</sup> ]	0.000032

#### Gear unit configuration

Fixing		Feet
Output shaft		AU 20x40

#### Output radial and axial loads

Output radial load	[N]	1020
Output axial load	[N]	204

#### Electric motor

Size		71 B4
Poles		4
Power	[kW]	0.37

#### Electric motor configuration

Motor flange		B14
Terminal box position		X3

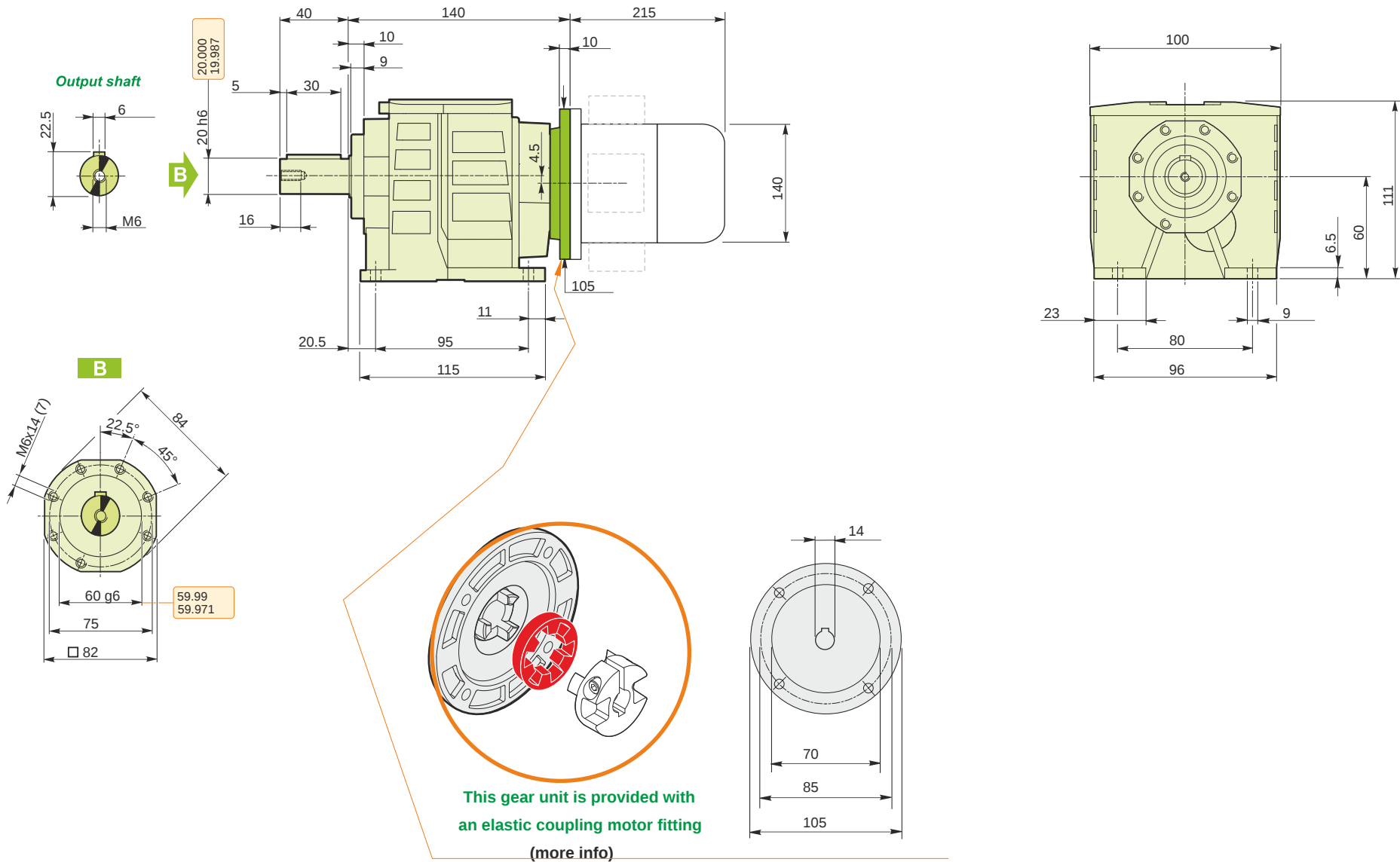

**M RD 02 B3 H1 16.32 71 B14 AU 20x40 MT 0.37 kW 71 B4 B14 X3**

**Mounting positions**

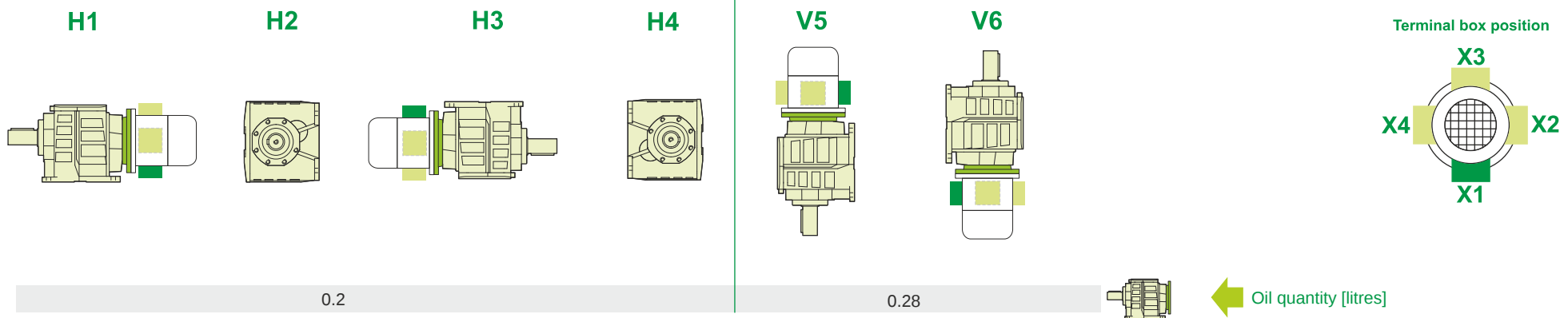

Lubricant type: Long life synthetic oil ISO VG320

**Direction of rotation**

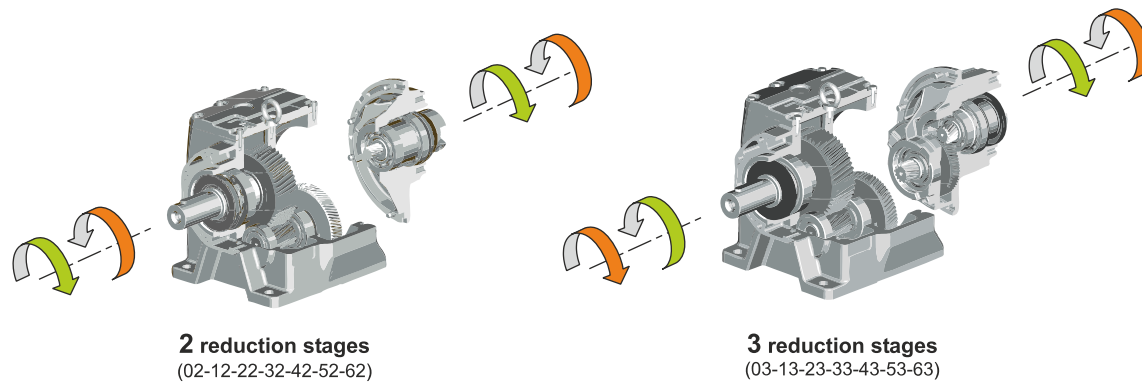

**Weight**

Gear unit [kg]	3
Electric motor [kg]	6.2

**M RD 02 B3 H1 16.32 71 B14 AU 20x40 MT 0.37 kW 71 B4 B14 X3**