

Input data

System of measurement		Metric
Input type		Gear motor
Input speed	[rpm]	1400
Output speed	[rpm]	6.78
Ratio (i=)		206.46
Frequency	[Hz]	50
Input options		IEC
Requested input power	[kW]	0.09
Service factor		0.8
Rated Power P1	[kW]	0.08

Output data

Gear unit **M RD 13 B3 H1 206.46 56 B5 AU 25x50 MT 0.09 kW 56 B4 B5 X3**

Type		RD - Helical gearboxes
Input type		M
Size		13
Ratio (i=)		206.46
Input flange		B5
Mounting position		H1
Input speed	[rpm]	1400
Output speed	[rpm]	6.78
Rated output torque	[Nm]	119.15
Service Factor		0.8
Efficiency		0.94
Inertia moment	[kgm ²]	0.000194

Gear unit configuration

Fixing		Feet
Output shaft		AU 25x50

Output radial and axial loads

Output radial load	[N]	2000
Output axial load	[N]	400

Electric motor

Size		56 B4
Poles		4
Power	[kW]	0.09

Electric motor configuration

Motor flange		B5
Terminal box position		X3

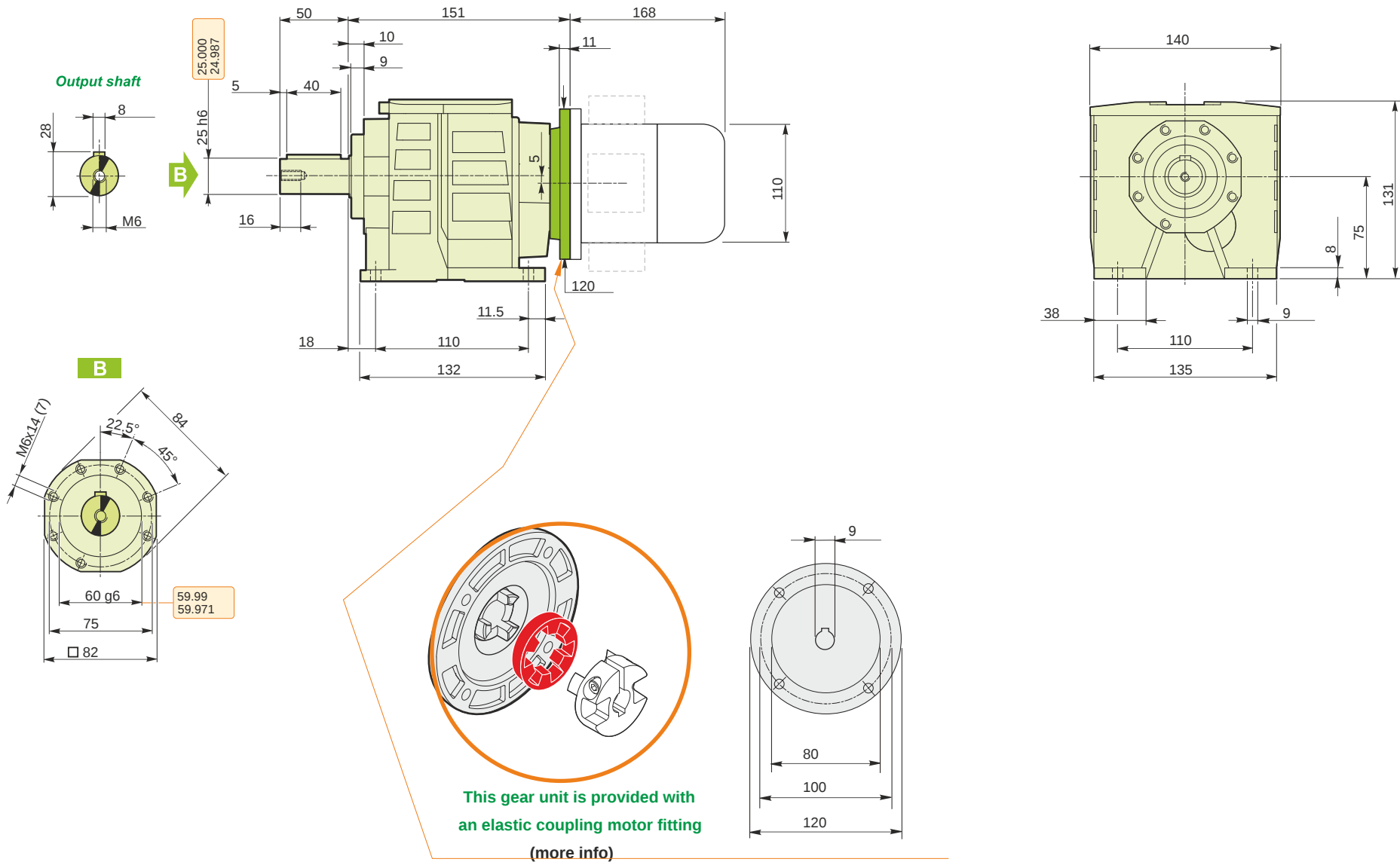

M RD 13 B3 H1 206.46 56 B5 AU 25x50 MT 0.09 kW 56 B4 B5 X3

Mounting positions

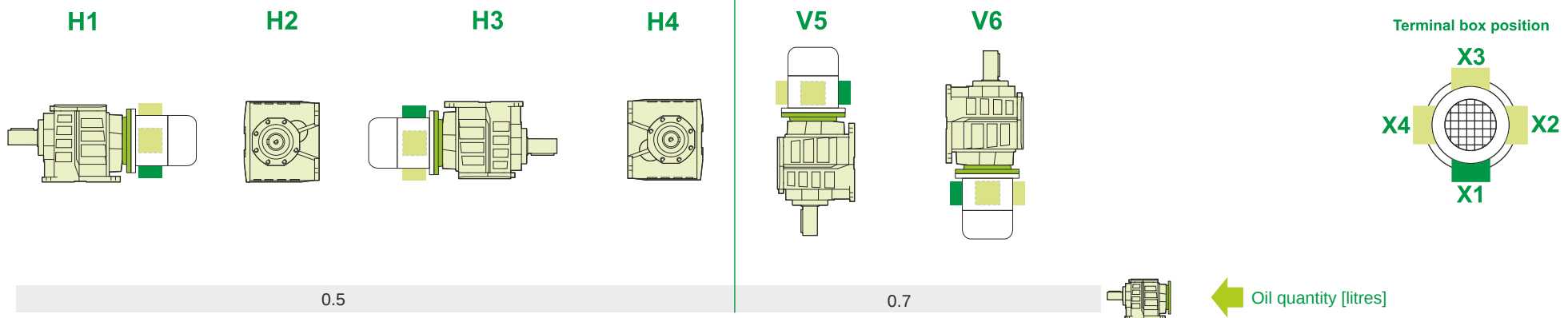

Lubricant type: Long life synthetic oil ISO VG320

Direction of rotation

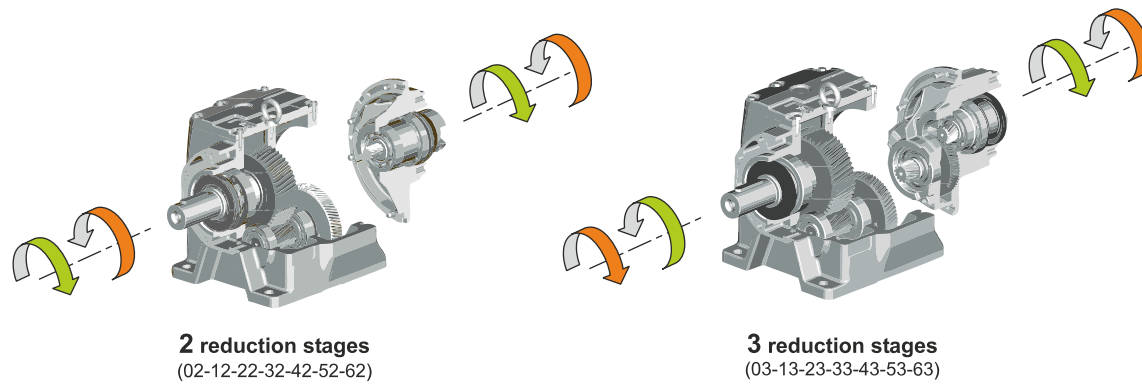

Weight

Gear unit [kg]	4.8
Electric motor [kg]	2.6

M RD 13 B3 H1 206.46 56 B5 AU 25x50 MT 0.09 kW 56 B4 B5 X3