

Input data

System of measurement		Metric
Input type		Gear motor
Input speed	[rpm]	1400
Output speed	[rpm]	8.34
Ratio (i=)		167.8
Frequency	[Hz]	50
Input options		IEC
Requested input power	[kW]	0.37
Service factor		1.1
Rated Power P1	[kW]	0.39

Output data

Gear unit **M RD 33 B3 H1 167.8 71 B14 AU 35x70 MT 0.37 kW 71 B4 B14 X3**

Type		RD - Helical gearboxes
Input type		M
Size		33
Ratio (i=)		167.8
Input flange		B14
Mounting position		H1
Input speed	[rpm]	1400
Output speed	[rpm]	8.34
Rated output torque	[Nm]	398.1
Service Factor		1.1
Efficiency		0.94
Inertia moment	[kgm ²]	0.000683

Gear unit configuration

Fixing		Feet
Output shaft		AU 35x70

Output radial and axial loads

Output radial load	[N]	4700
Output axial load	[N]	940

Electric motor

Size		71 B4
Poles		4
Power	[kW]	0.37

Electric motor configuration

Motor flange		B14
Terminal box position		X3

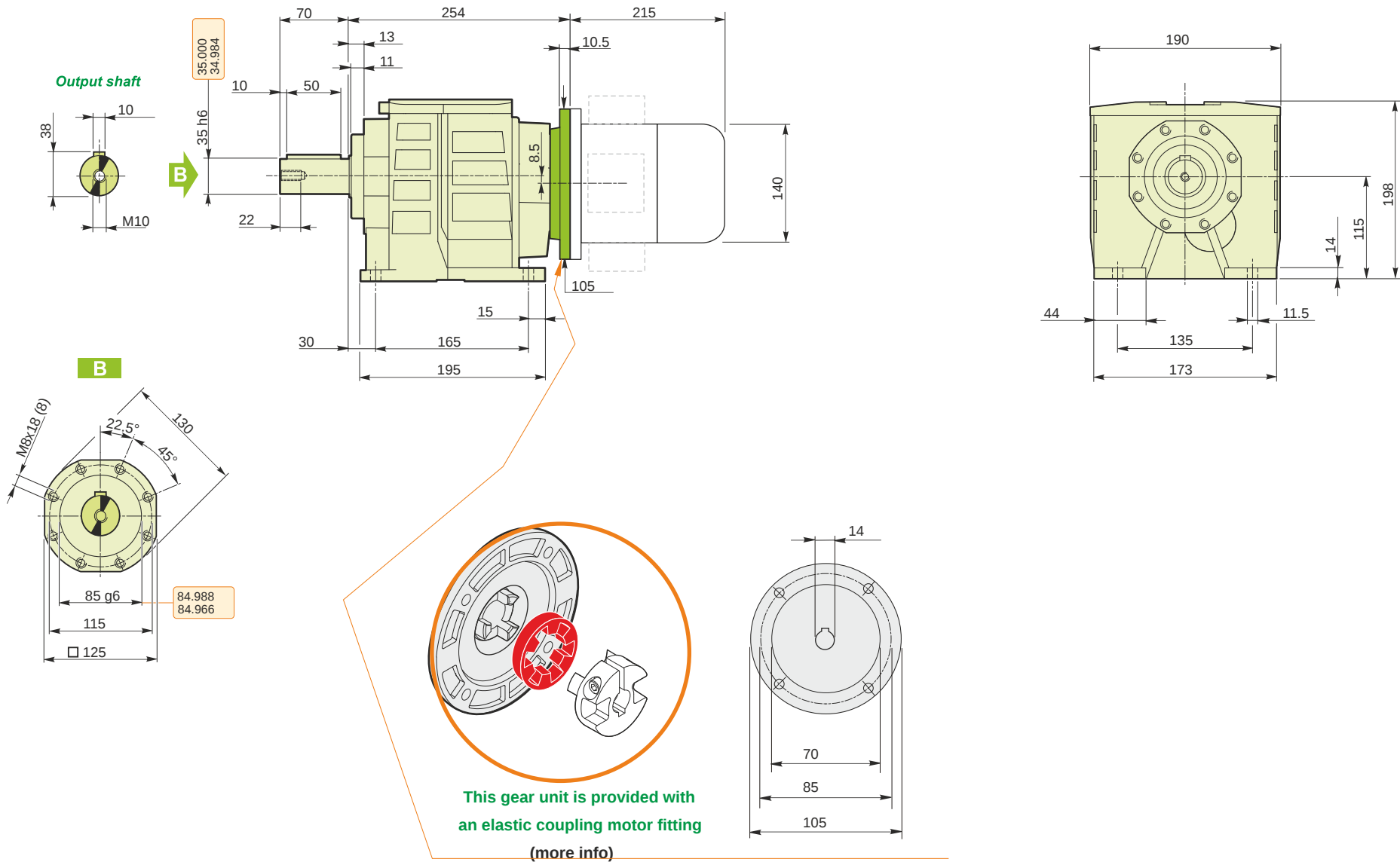

M RD 33 B3 H1 167.8 71 B14 AU 35x70 MT 0.37 kW 71 B4 B14 X3

Mounting positions

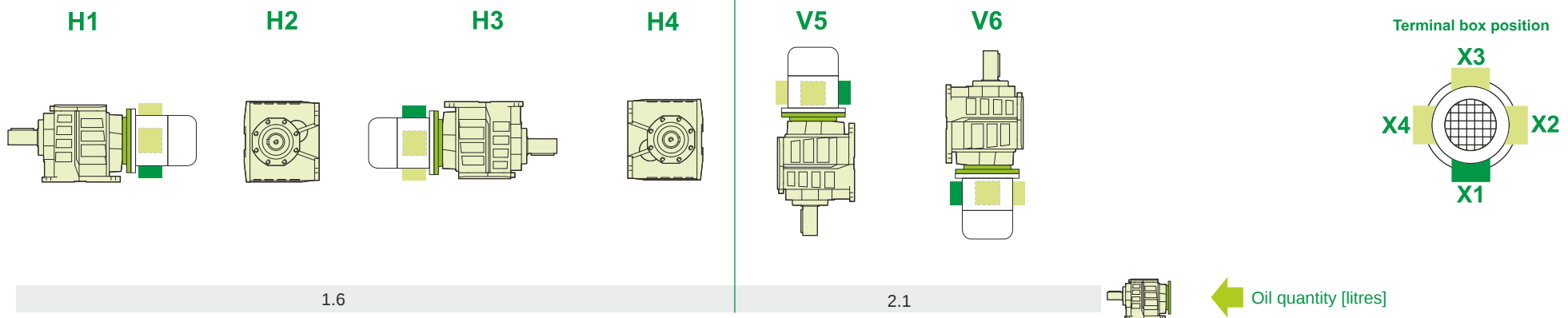

Lubricant type: Long life synthetic oil ISO VG320

Direction of rotation

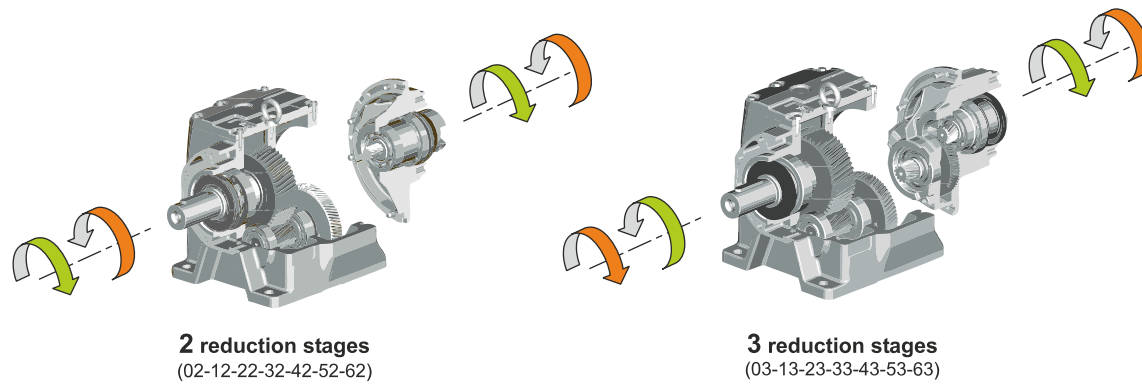

Weight

Gear unit [kg]	14.5
Electric motor [kg]	6.2

M RD 33 B3 H1 167.8 71 B14 AU 35x70 MT 0.37 kW 71 B4 B14 X3